

Artcoustic^{AC}

EVOLVE 1 INDOOR AND OUTDOOR SPEAKER

Owners manual

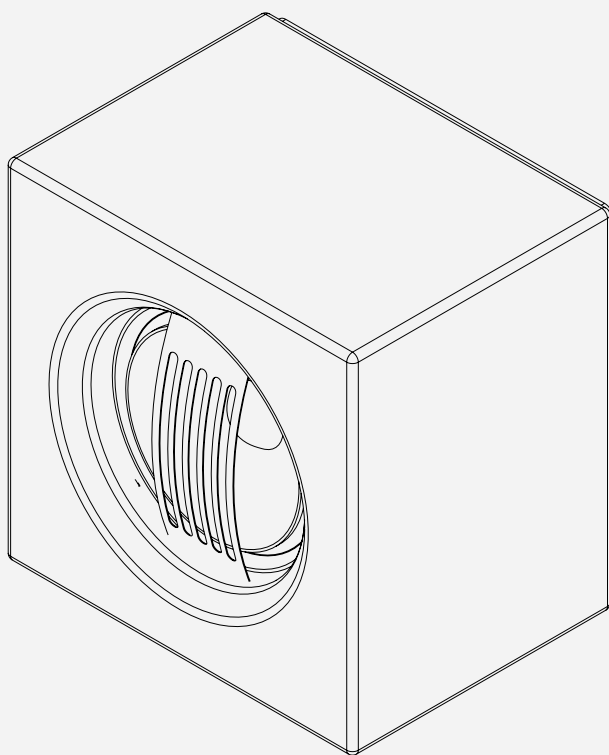

WELCOME TO THE WORLD OF ARTCOUSTIC

Congratulations on your purchase of the Evolve 1 Speaker.

The Evolve 1 shares many characteristics with the other models in the Artcoustic range. Maintaining Artcoustic's clean contemporary design, the Evolve 1 has been designed and engineered for a wide range of applications, suited for most indoor and outdoor spaces, where premium sound quality and flexibility are required.

The Evolve 1 speaker can be expanded as a dual array speaker for higher sound pressure levels and further controlled horizontal and vertical dispersion, typically needed for more commercial applications.

The Evolve 1 has predominantly been designed as a multi-room-indoor high-fidelity audio solution but is also available for outdoor applications. As a unique feature, the Evolve 1 is available in our special outdoor high gloss IP66 (weatherproof) surface material, making it not only one of the most aesthetic outdoor audio solutions around, but it will also extend the legendary high standard of Artcoustic audio quality into any of your outdoor areas.

The Evolve 1 is an impressive-sounding semi full-range speaker solution, packed with high-end finesse and an impressive dynamic range, all from a very small and aesthetic form factor.

The Evolve 1 has been designed to match the same tonality as the rest of the Artcoustic range and will especially excel in conjunction with the Artcoustic CPH-Trio amplifier, but can also be used with any other high-quality power source.

Thank you for purchasing the Artcoustic Evolve 1.

All the best,

The Artcoustic Team

FEATURES

EVOLVE 1 SPEAKER

HIGH PERFORMANCE, HIGH OUTPUT

The slim line profile, combined with powerful and articulated performance, makes the Evolve 1 speaker an ideal choice for high-end residential, commercial and outdoor audio installations

EVOLVE 1 SPARKLING HIGH-FREQUENCY PERFORMANCE

The Evolve 1 series excels at the upper end of the frequency spectrum, with a frequency response of up to 20 kHz. Overall, the performance is exemplary with good, articulated mid-range and sparkling high-frequency performance. All within Artcoustic's Scandinavian design aesthetic.

IDEAL FOR OUTDOOR INSTALLATIONS

The Evolve 1 series is ideal for stereo and multi-channel listening, small to medium-sized patios, commercial use in outdoor bars, restaurants and pool areas and in general all medium SPL IP-rated outdoor areas, such as gardens, yachts, hotels and in general weather demanding installations.

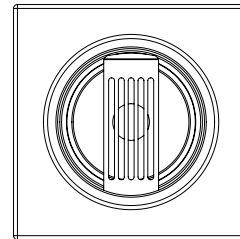

Evolve 1 front view

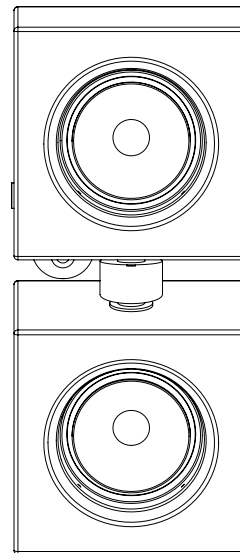

Evolve 1 Array front view

COMPONENTS OVERVIEW

EVOLVE 1 FULL-RANGE DRIVER

Extra long excursion and aluminium Short Circuiting Ring, 4-layer voice coil, anodised aluminium for improved heat dissipation, combined with Distortion Reduced Motor.

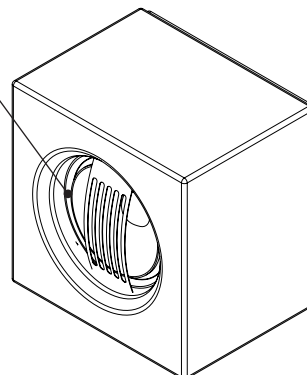

isometric front view

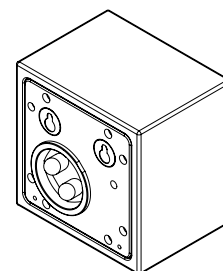

isometric rear view

SPECIFICATIONS

EVOLVE 1 SPEAKER

TRANSDUCER

FR 1 x 3 inch cone

CONNECTION

Single Amped Gold Plated Push Terminals

PERFORMANCE

Operating Range 100 Hz (-6dB) to 20 kHz

Axial Sensitivity (Half Space SPL) FR 88 dB

Calculated Axial Output Limit (Half Space SPL) Average Peak 104 dB

Maximum Power Handling 2 hours of 6 dB crest factor pink noise,

30 Watt RMS (AES Standard)

Input Impedance Nominal 8 ohms

Nominal Beamwidth Horizontal 90° Vertical 90°

DESIGN

Cabinet: Indoor Black, White, RAL, NCS

Outdoor IP66 standard colour NCS S 2500-N. optional RAL and NCS

Screen: IP66 standard Black metal grille

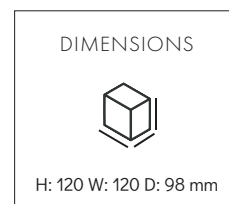
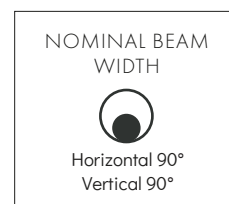
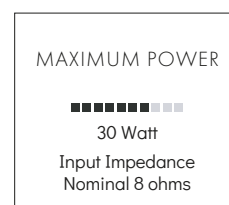
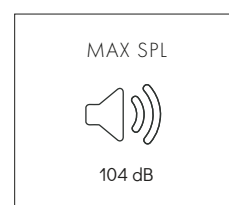
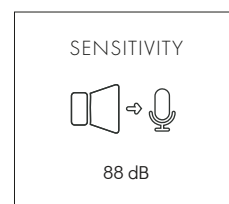
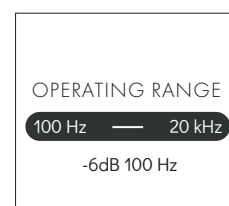

SPECIFICATIONS

EVOLVE 1 ARRAY

TRANSDUCER

FR 2 x 3 inch cones

CONNECTION

Single Amped Gold Plated Push Terminals

PERFORMANCE

Operating Range 100 Hz (-6dB) to 20 kHz

Axial Sensitivity (Half Space SPL) FR 94 dB

Calculated Axial Output Limit (Half Space SPL) Average Peak 110 dB

Maximum Power Handling 2 hours of 6 dB crest factor pink noise,
60 Watt RMS (AES Standard)

Input Impedance Nominal 4 ohms

Nominal Beamwidth Horizontal 135° Vertical 95°

DESIGN

Cabinet: Indoor Black, White, RAL, NCS

Outdoor IP66 standard colour NCS S 2500-N. optional RAL and NCS

Screen: IP66 standard Black metal grille

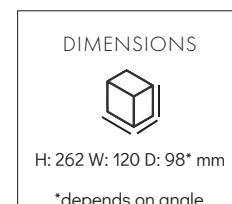
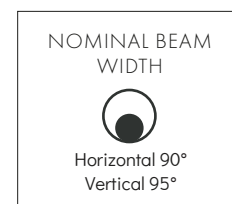
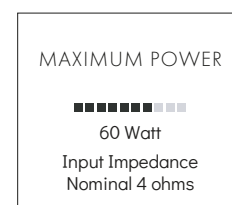
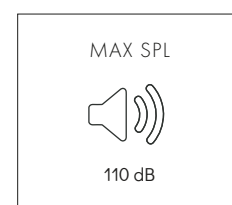
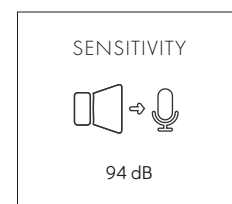
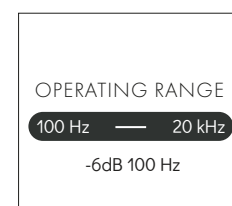

SCHEMATICS - INDOOR

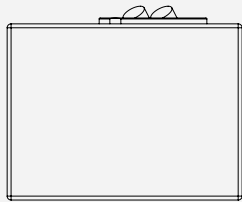

top view

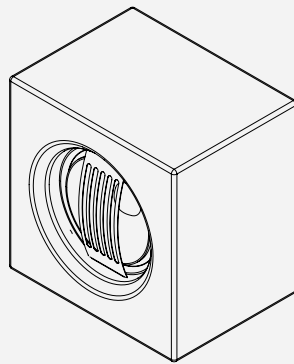

isometric view

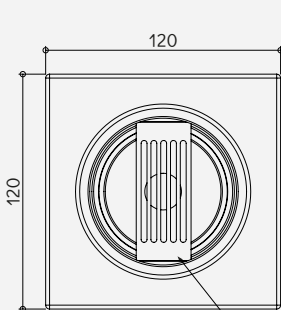
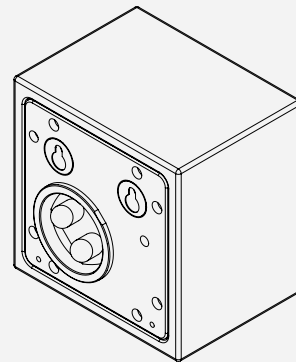

front view

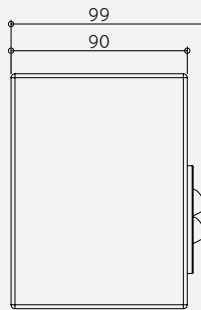

side view

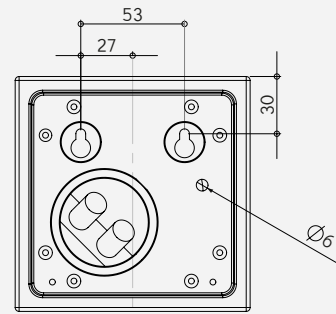

rear view

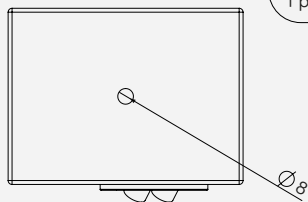

bottom view

Evolve 1 Grille
Optional and attachable aluminum grille
1 piece shipped with every speaker

Evolve 1 Grille

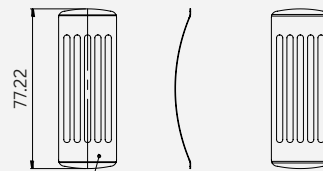

IP66 Power coated metal
BLACK



SCHEMATICS - OUTDOOR

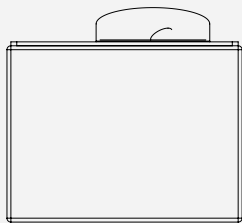

top view

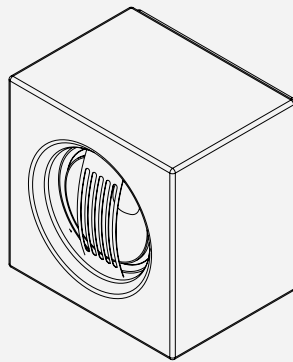

isometric view

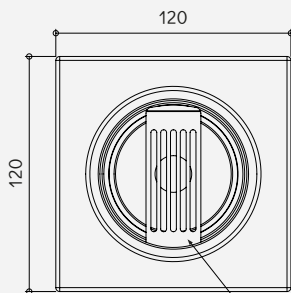
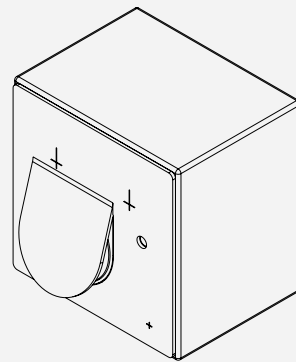

front view

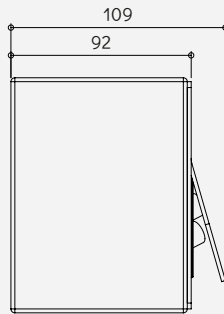

side view

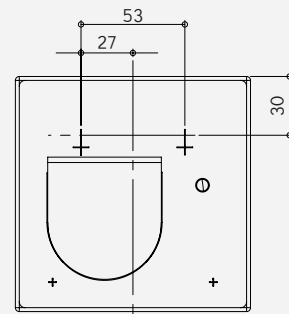

rear view

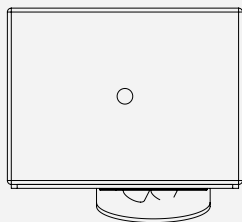

bottom view

Evolve 1 Grille
Optional and attachable aluminum grille
1 piece shipped with every speaker

Evolve 1 Grille

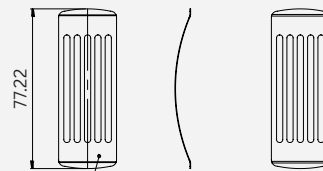

IP66 Power coated metal
BLACK



SCHEMATICS - STAND MOUNTING

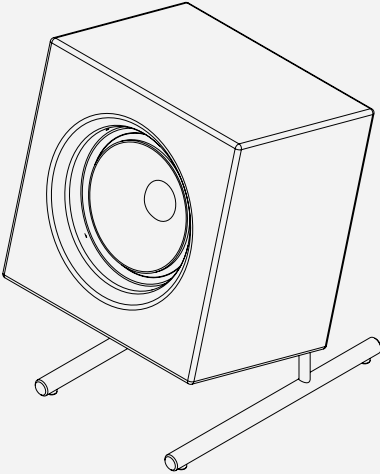

isometric front view

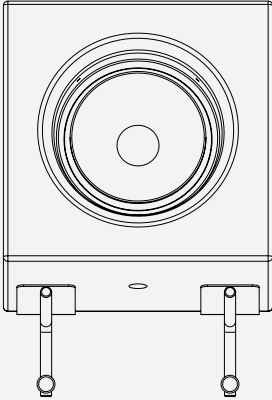

front view

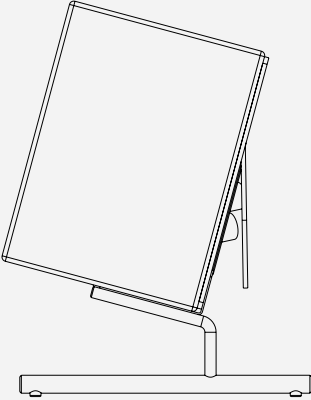

side view

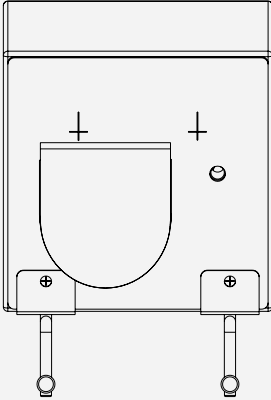

rear view



SCHEMATICS - GARDEN ROD MOUNTING

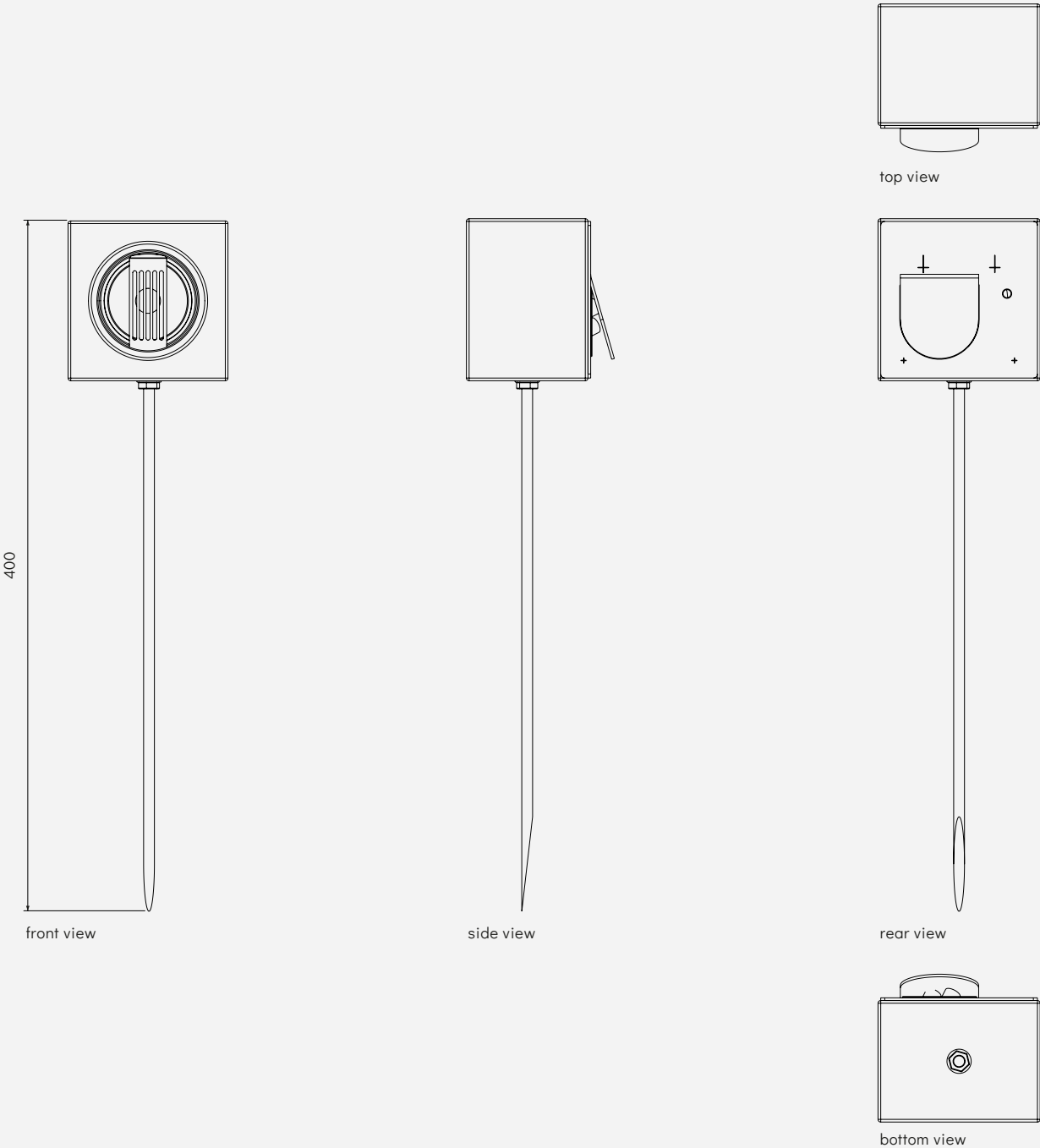

SCHEMATICS - ARRAY

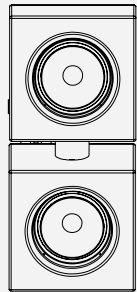

front view

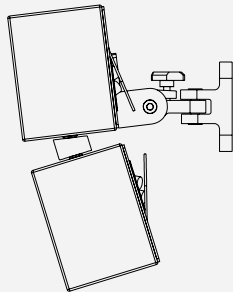

side view

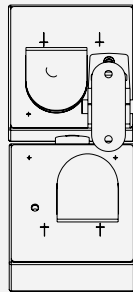

rear view

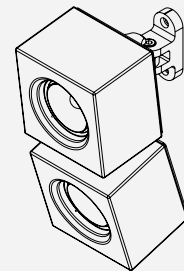

on-wall mounting
isometric front view

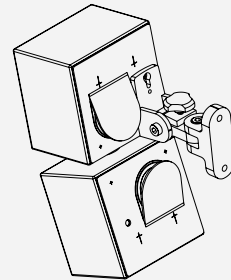

on-wall mounting
isometric back view

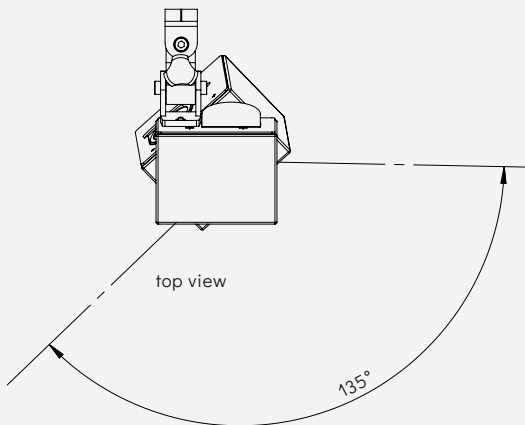

top view

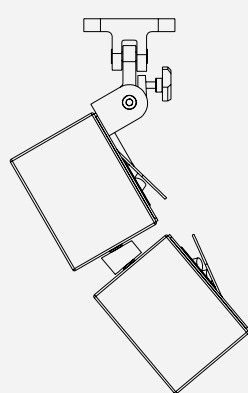

side view

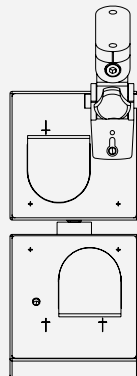

rear view

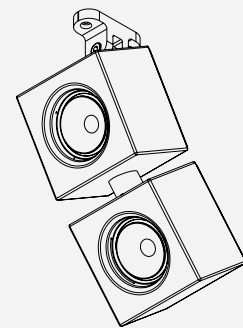

on-ceiling mounting
isometric front view

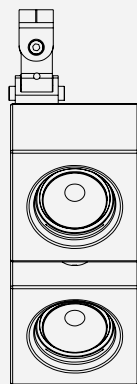

front view

MOUNTING INSTRUCTIONS

EVOLVE 1 SPEAKER

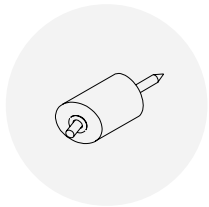

Universal Alu Mount
Mount to wall with suitable wall plugs

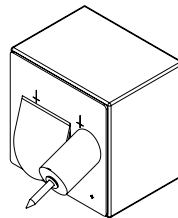

rear mounting
isometric rear view

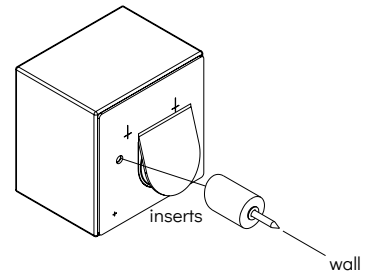

Evolve 1
Mount speaker to bracket,
rotating clockwise

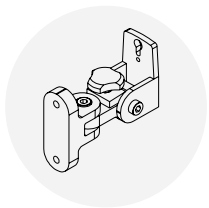

Artcoustic Universal Bracket
Mount Bracket to wall, with suitable screws

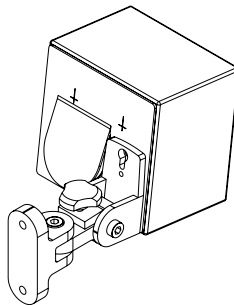

isometric rear view

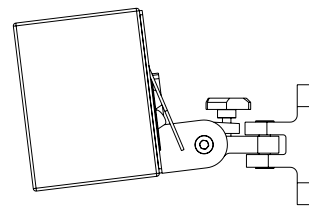

side view

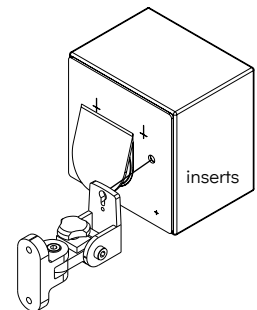

Evolve 1
Mount speaker to bracket

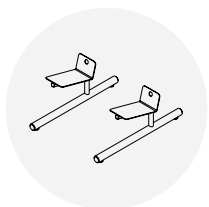

Speaker Stand

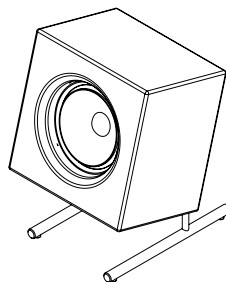

isometric front view

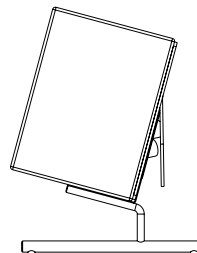

side view

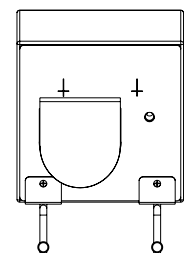

rear view

Evolve 1
Mount stands to speaker
with supplied screws

MOUNTING INSTRUCTIONS

EVOLVE 1 ARRAY

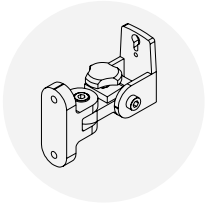

Artcoustic Universal Bracket
Mount Bracket to wall,
with suitable screws

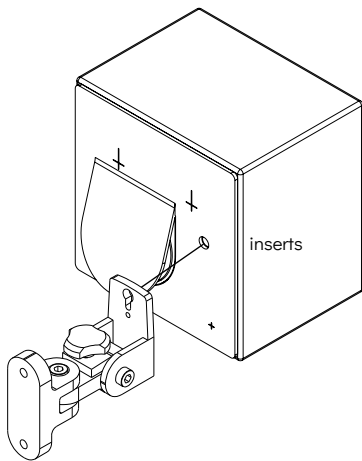

isometric rear view

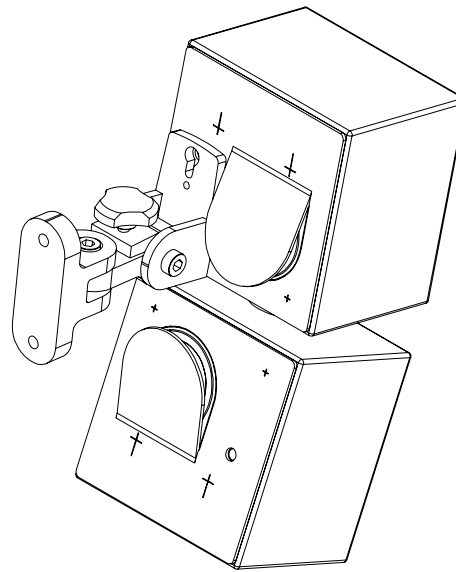

Evolve 1 Array
Mount bracket to speaker

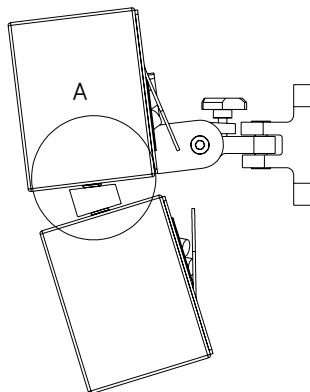

Evolve 1 Array
side view

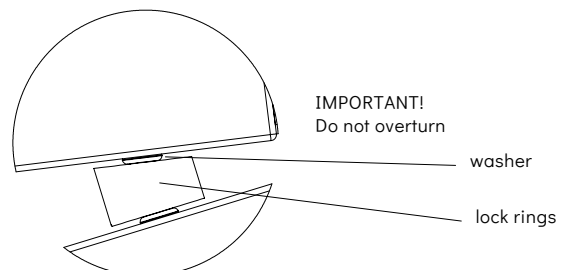

detail A
scale 1:2

MOUNTING INSTRUCTIONS

GARDEN ROD

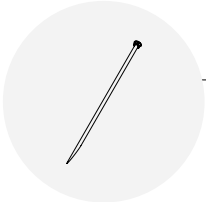

Garden Rod

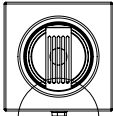

B

Evolve 1 front view

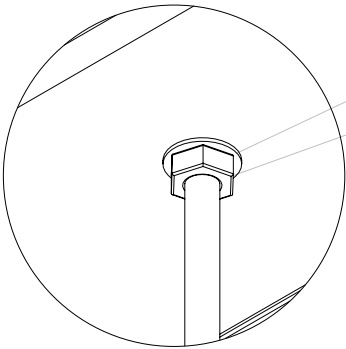

IMPORTANT!
Do not overturn

washer
nut

detail B
scale 1:1



MOUNTING INSTRUCTIONS

OUTDOOR INSTALLATION GUIDELINES

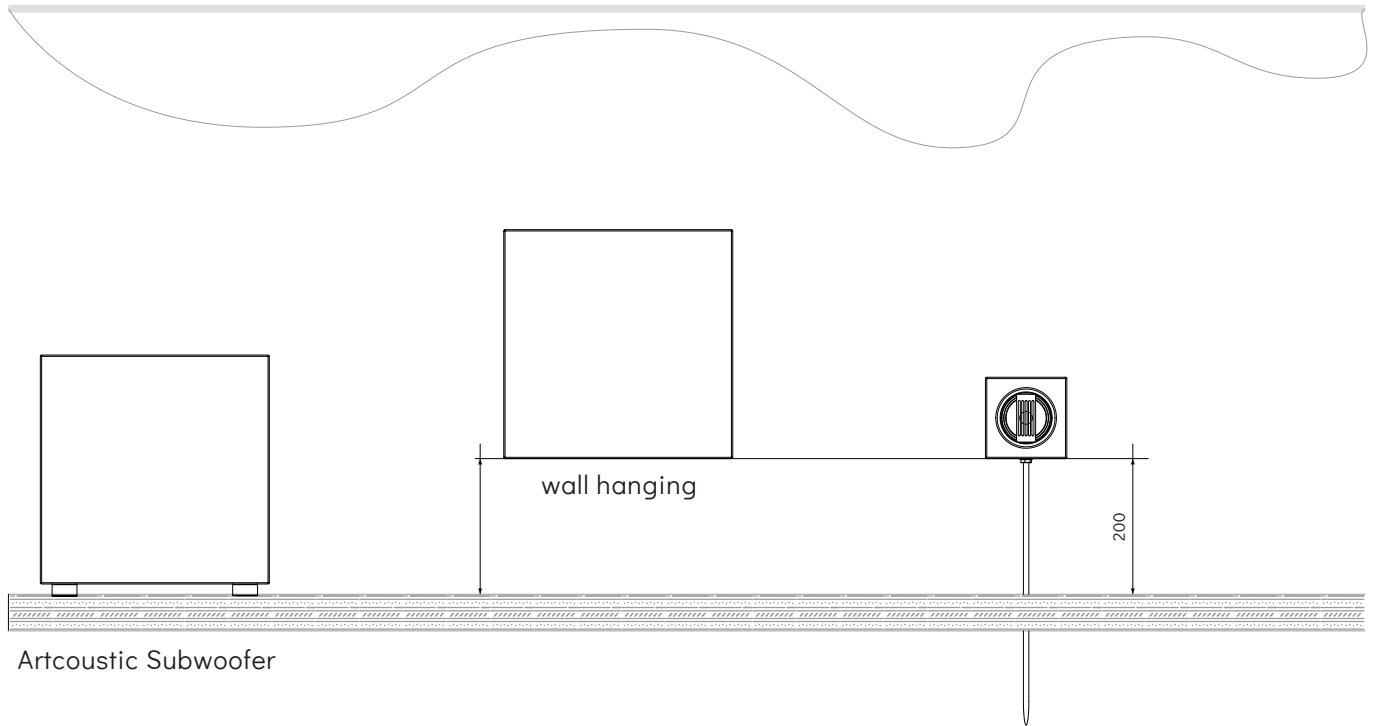

Artcoustic Subwoofer

Only place subwoofer close to ground and on rubber feet, in dry or rain covered areas

Artcoustic subwoofers ship as IP55 and will have to be placed under a direct rain cover

Ideal position for very wet areas and risk of high water levels, place subwoofer on-wall 200mm from ground

For installations in direct rain, speakers should be placed minimum 200 mm from ground

POLAR RESPONSE

EVOLVE 1 SPEAKER

horizontal polar response 1m

16000Hz - - - - -
 6500Hz - - - - -
 2500Hz - - - - -
 1000Hz - - - - -

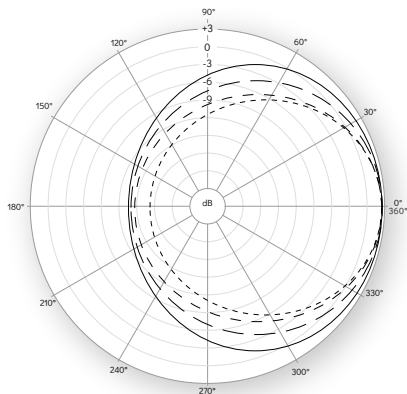

vertical polar response 1m

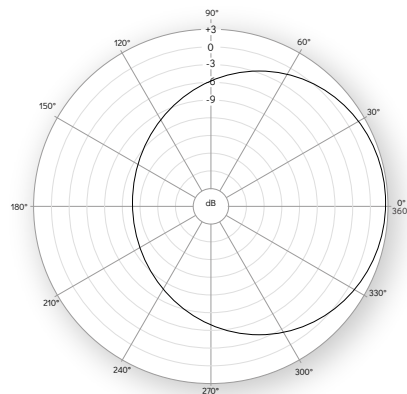

3D polar response 1m

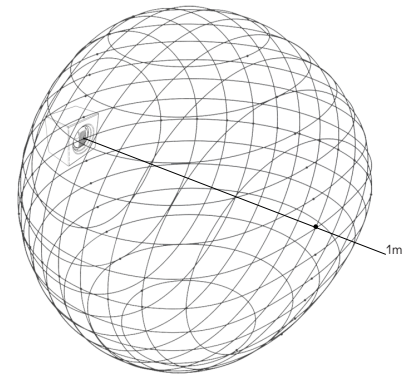

EVOLVE 1 ARRAY

horizontal polar response 1m

16000Hz - - - - -
 6500Hz - - - - -
 2500Hz - - - - -
 1000Hz - - - - -

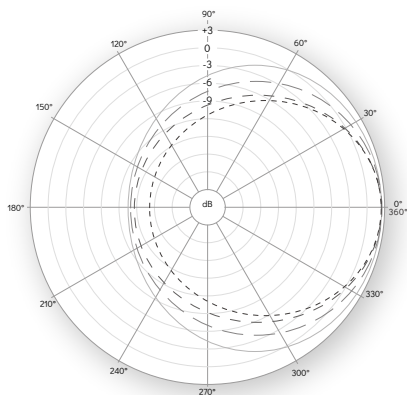

vertical polar response 1m

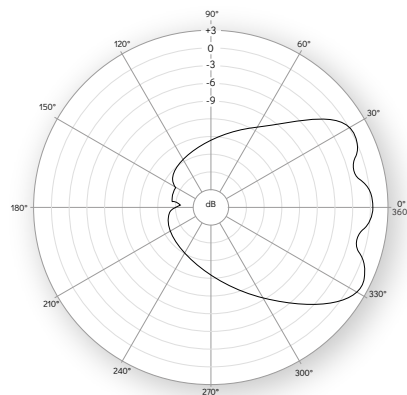

3D polar response 1m

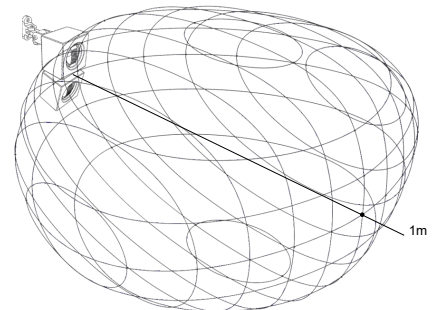

PACKAGE

EVOLVE 1 SMALL SPACE PACKAGE

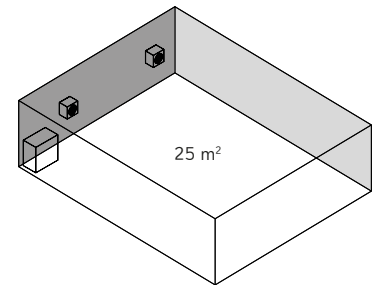
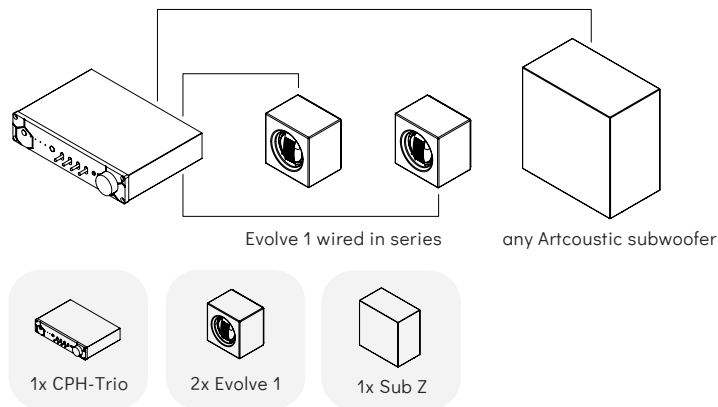

PERFORMANCE

Operating Range 35 Hz (-3dB) to 20 kHz

Axial Sensitivity (Half Space SPL) Evolve 1 91 dB | Sub Z 94 dB

Calculated Axial Output Limit (Half Space SPL) Average Peak Evolve 1 104 dB | Sub Z 106 dB

Maximum Power Handling Evolve 1 30 Watt | Sub Z 160 Watt

Input Impedance Nominal Evolve 1 8 ohms | Sub Z 7 ohms

EVOLVE 1 SMALL-MEDIUM PACKAGE

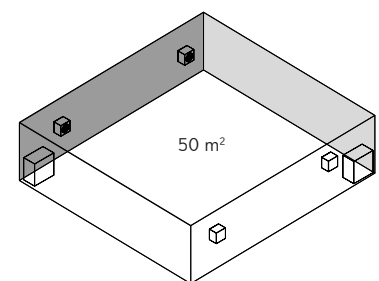
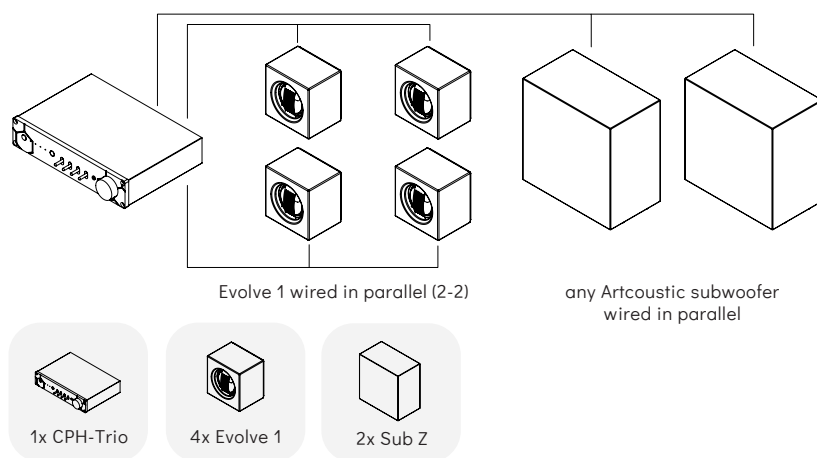

PERFORMANCE

Operating Range 35 Hz (-3dB) to 20 kHz

Axial Sensitivity (Half Space SPL) Evolve 1 97 dB | Sub Z 100 dB

Calculated Axial Output Limit (Half Space SPL) Average Peak Evolve 1 110 dB | Sub Z 112 dB

Maximum Power Handling Evolve 1 120 Watt | Sub Z 360 Watt

Input Impedance Nominal Evolve 1 4 ohms | Sub 4 ohms

PACKAGE

EVOLVE 1 SMALL-MEDIUM SPACE PACKAGE, EXTENDED FREQUENCY

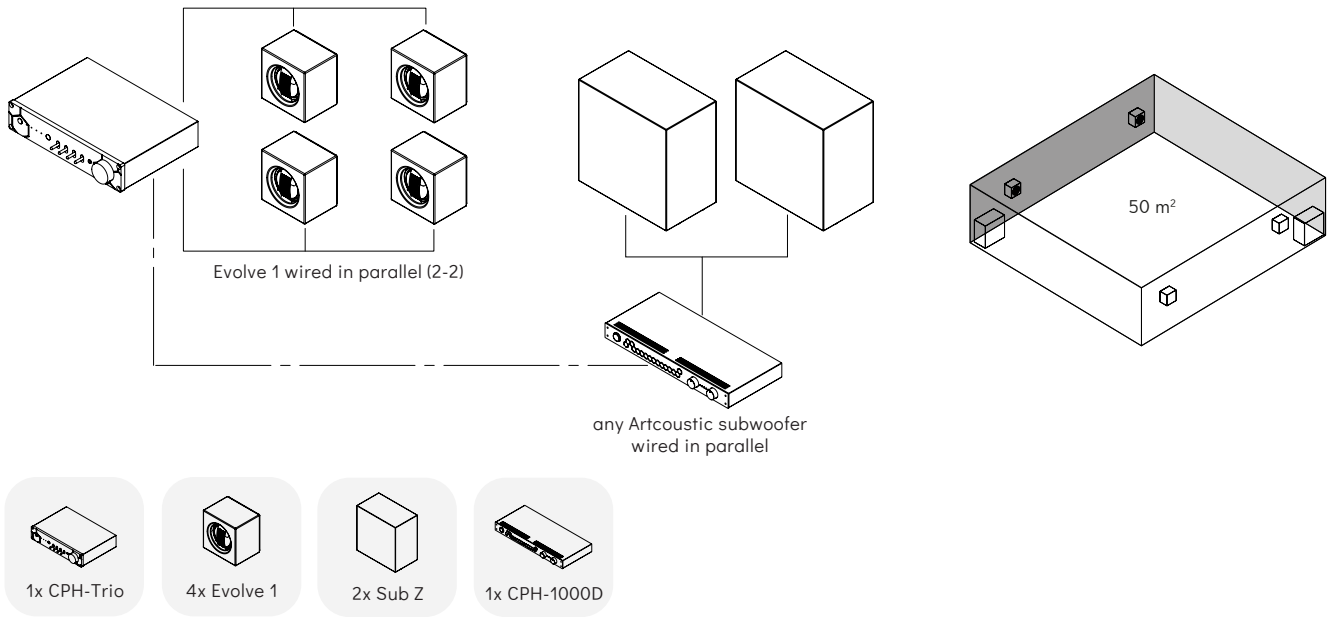

PERFORMANCE

Operating Range 35 Hz (-3dB) to 20 kHz

Axial Sensitivity (Half Space SPL) Evolve 1 97 dB | Sub Z 100 dB

Calculated Axial Output Limit (Half Space SPL) Average Peak Evolve 1 110 dB | Sub Z 116 dB

Maximum Power Handling Evolve 1 120 Watt | Sub Z 360 Watt

Input Impedance Nominal Evolve 1 4 ohms | Sub 4 ohms

PACKAGE

EVOLVE 1 MEDIUM-LARGE SPACE PACKAGE

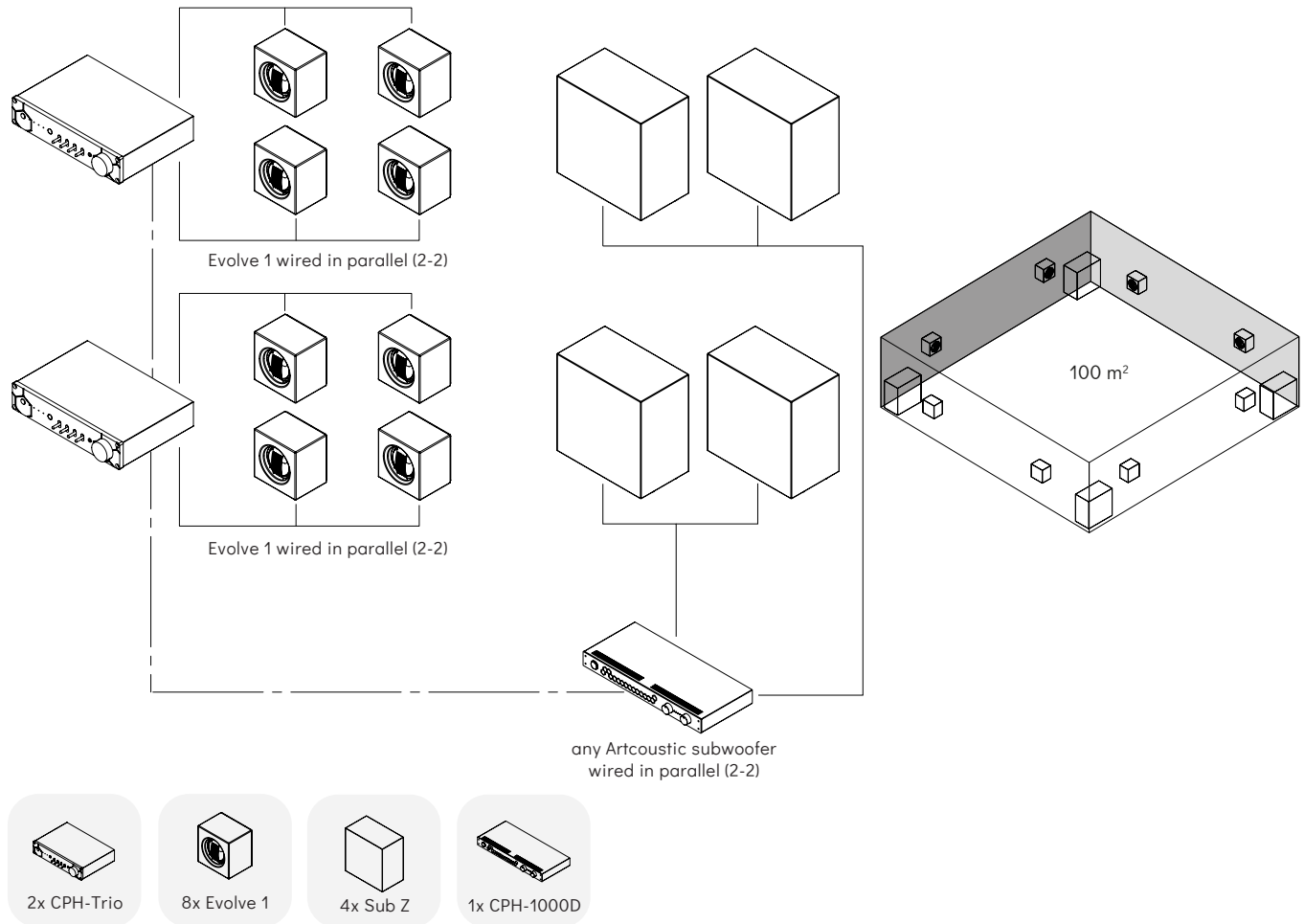

PERFORMANCE

Operating Range 35 Hz (-3dB) to 20 kHz

Axial Sensitivity (Half Space SPL) Evolve 1 100 dB | Sub Z 103 dB

Calculated Axial Output Limit (Half Space SPL) Average Peak Evolve 1 116 dB | Sub Z 119 dB

Maximum Power Handling Evolve 1 240 Watt | Sub Z 640 Watt

Input Impedance Nominal Evolve 1 4 ohms | Sub Z 4 ohms

SAFETY INSTRUCTIONS

SAFETY



Clean rear panel
with dry cloth only



Do not block any
ventilation opening



Do not install near
any heat sources

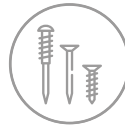

If wall mounted,
ensure the use of
matching screws
and rawl plugs

WARNING

This product complies with Part 15 of the FCC Rules.
Its operation is subject to the following two conditions:

This product may not cause harmful interference.

This product must accept any interference received,
including interference that may cause undesired
operation.

Changes or modifications not expressly approved by the
party responsible for compliance could void the user's
authority to operate the equipment.

IMPORTANT!

Carefully check all products when unpacked.
Do not install any IP-rated products, if speaker surface has
been damaged in any ways.

WARRANTY

IS APPLICABLE



Is valid only for products purchased from an authorised Artcoustic retailer or dealer.



Is valid from the date of purchase for a period of 3-years for passive loudspeakers, and 2-years for powered loudspeakers and electronics.



Is limited to the repair of the equipment (which could be a repair or replacement at our discretion, neither of which affects your original warranty).



Neither transportation, nor any other costs, nor any risk for removal, transportation and installation of products is covered by this warranty.

IS NOT APPLICABLE

Will not be applicable in cases other than defects in materials and/or workmanship at the time of purchase and will not be applicable:

- For deterioration of component parts, the nature of which is to become worn or depleted with use, such as batteries.
- For damages caused by incorrect installation, connection or packing.
- For damages caused by accidents, lightning, water, fire heat, war, public disturbances or any other cause beyond the reasonable control of Artcoustic and its appointed distributors.
- For damages caused by any use other than correct use described in the user manual, negligence, modifications, or use of parts that are not made or authorized by Artcoustic.
- For colouration or de-colouration caused by weather, or natural outdoor materials
- For damages on speaker surface, caused by external factors, such as garden machineries, pool equipment and in general self-inflicted physical damages.

If it is found necessary to return the product for repair, you will be given a form to fill out and return. You should not return the product without previous acceptance. To validate your warranty, you will need to produce the original sales invoice or other proof of ownership and date of purchase.