

DIN-Rail 8-Channel Relay Switch Installation Guide



Introduction

The Control4® DIN-Rail 8-Channel Relay Switch (C4-DIN-8RELSW-E) controls up to eight devices from one module in the Control4 system. It installs in a DIN rail panel using typical wiring standards and communicates to the Control4 system using a Cat5 Ethernet connection.

Note: For optimal product and network security, we recommend using this product with Control4 OS 3.2.2 or newer.

Box contents

- 8-Channel Relay Switch
- 8-Channel Relay Switch Installation Guide (this document)
- 8-Channel Relay Switch Wiring Guide (ctrl4.co/8chrelay-wiring)

Specifications and supported fixtures

| | | | |
|-----------------------------|--|------------------------------|-------------|
| Model number | C4-DIN-8RELSW-E | | |
| Power requirements | 100-277VAC, 50/60 Hz UL Certified 240VAC, 50 Hz CE Certified | | |
| Line in (circuits) | 4 | | |
| Power consumption | 3.5W | | |
| Supported load types | Incandescent, halogen, electronic low-voltage transformers (ELV), magnetic low-voltage transformers (MLV), fluorescents, compact fluorescents, LEDs, and motors. | | |
| Control communications | Ethernet | | |
| Load ratings | | | |
| | 120V | 240V | 277V |
| Module max | 64A | 64A | 64A |
| Line 1 in max | 16A | 16A | 16A |
| Line 2 in max | 16A | 16A | 16A |
| Line 3 in max | 16A | 16A | 16A |
| Line 4 in max | 16A | 16A | 16A |
| Individual channel max | 16A 1 HP | 16A 2 HP 6(5)A, cos φ=0,6 | 16A |
| Connections | | | |
| Line-voltage push terminals | 19 (Line 1, Line 2, Line 3, Line 4, Neutral 1, Neutral 2, Neutral 3, Neutral 4, Earth Ground, Loads 1-8, Aux In, Aux Out) | | |
| Recommended wiring size | One 26 AWG to 12 AWG (0.12 mm ² to 2.5 mm ²) per terminal | | |
| RJ-45 ports | 2 (1 Ethernet in, 1 Ethernet passthrough) | | |
| Environmental | | | |
| Operational temperature | 0 to 40 °C (32 to 104 °F) | | |
| Humidity | 5% to 95% non-condensing | | |
| Storage | -20 to 70 °C (-4 to 158 °F) | | |
| Dimensions | | | |
| H x W x D | 219 x 115 x 57 mm (8.6 x 4.5 x 2.2 in.) | | |

| | |
|------------------|-------------------|
| DIN module width | 12M |
| Weight | 1.3 kg (2.9 lbs) |
| Shipping eight | 1.49 kg (3.3 lbs) |

Warnings and considerations

Warning! Turn OFF electrical power to all circuit breakers feeding into the panel before installing or servicing this product. Improper use or installation can cause SERIOUS INJURY, DEATH, or LOSS/DAMAGE OF PROPERTY.

Attention ! Coupez l'alimentation électrique à tous les disjoncteurs d'alimentation à le panneau avant d'installer ou de réparer ce produit. Une mauvaise installation ou utilisation peut entraîner des blessures graves, décès, ou perte / dommages à la propriété.

Warning! This device must be protected by a circuit breaker (20A max).
Attention ! Cet appareil doit être protégé par un disjoncteur (20A max).

Warning! DO NOT rely solely upon the device's contact with a metal panel for adequate grounding. Use the device's ground terminal to make a secure connection to the safety ground of the electrical system.

Attention ! NE COMPTÉZ PAS uniquement soley au contact de l'appareil avec un panneau métallique de mise à la terre adéquate. Utilisez la borne de terre de l'appareil d'établir une connexion sécurisée à la terre de sécurité du système électrique.

Caution! If this product is used as a means to open and close a garage door, gate, or similar device, use safety or other sensors to ensure safe function. Follow appropriate regulatory and safety standards governing project design and installation. Failure to do so may result in property damage or personal injury.

Important! This device must be installed by a licensed electrician in accordance with all national and local electrical codes.

Important! The panel used with this device is air cooled. Install the panel in a location where the vented cover is not blocked. At least 12 inches (30 cm) clearance is required away from the front of the panel. Some local codes may require as much as 30 inches (76.2 cm) clearance.

Important! Install this device only indoors.

Important! Using this product in a manner other than outlined in this document voids your warranty. Further, Control4 is *not* liable for any damage incurred with the misuse of this product. See "Troubleshooting."

Important! Changes or modifications not expressly approved by Control4 could void the user's authority to operate the equipment.

Important! 10/100 Ethernet port can only be used to chain together a total of six Control4 panelized devices in the same panel.

Figure 1. Front view

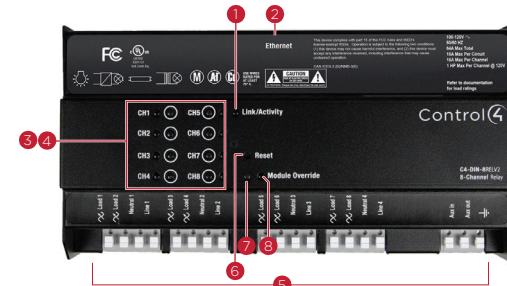

- 1 Link/Activity LED
- 2 Ethernet RJ-45 ports
- 3 Channel status LEDs
- 4 Channel buttons
- 5 Line-voltage terminals
- 6 Reset button (recessed)
- 7 Module status LED
- 8 Module Override button

Pre-installation instructions

Before you install in a Control4 panel:

- 1 Use Composer Pro to add the 8-Channel Relay Switch to a project, define its location in a panel, and print the Panel, Module, or Load Schedule Reports. See the *Composer Pro User Guide* (ctrl4.co/cpro-ug) for details.
- 2 Install the panel following the instructions in the *5-Slot and 2-Slot Panel Installation Guide*.
- 3 Install and wire the terminal block for the 8-Channel Relay Switch following the instructions in the *Terminal Block Installation Guide* and in the location defined by the Composer Pro Panel Reports.

Figure 2. Terminal block bypass jumpers

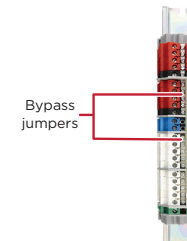

- 4 Verify that all bypass jumpers are securely installed in the terminal block assemblies. Each 8-Channel Relay Switch terminal block assembly should have eight bypass jumpers installed, connecting each black terminal block to two red terminal blocks, and connecting each set of three white terminal blocks together.
- 5 Turn on the circuit breaker(s) feeding the terminal block and verify that the circuit breaker(s) do not trip. If a breaker trips, do not proceed with installation until the problem has been resolved.
- 6 Turn off the circuit breakers for all lines coming into the panel.
- 7 Remove the four bypass jumpers that connect each black terminal to two red terminals by unscrewing all three screws in each bypass jumper until the entire bypass jumper can be removed.

Caution! Store the bypass jumper for possible later use. The bypass jumper should be reinstalled any time the load will be serviced. Test the circuit with the jumper installed before removing the jumper again. Damage to the module caused by miswiring is not covered by the warranty.

Attention ! Conservez le cavalier pour un usage ultérieur. Le cavalier devra être réinstallé à tout moment pour effectuer un entretien. Veuillez évaluer le circuit avec le cavalier en place avant de le retirer à nouveau. Un dommage au module engendré par un mauvais branchement n'est pas couvert par la garantie de Control 4.

Before you install in a third-party DIN rail panel

- 1 Install the third-party panel according to the third-party instructions.
- 2 Install the panel in a well-ventilated area.

Caution! Test all wiring for short circuits before installing the module. Damage to the module caused by miswiring is not covered by the Control4 warranty.

Attention ! Testez tout le câblage pour les courts-circuits avant d'installer le module. Un dommage au module engendré par un mauvais branchement n'est pas couvert par la garantie de Control 4.

Installation instructions

Install in a Control4 panel

The 8-Channel Relay Switch should be installed in the panel next to the previously installed 8-Channel Relay Switch terminal block. The location of the device in the panel is defined by the Composer Pro Panel Report.

- 1 With the gray push terminals on the left side of the 8-Channel Relay Switch, hold the relay upright and angle it to the left so that the left side of the module fits onto the rail in the panel (see Figure 3).

Figure 3. Attach the 8-Channel Relay Switch to a Control4 Panel

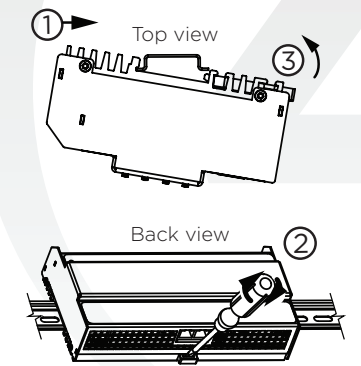

Note: The 8-Channel Relay Switch installs with the line-voltage terminals on the left side and the Ethernet ports on the right side.

- 2 With the left side already in place, use a flat blade screwdriver to move the latch.
- 3 While pressing forward on the right side of the dimmer, release the latch to secure it onto the rail.

Note: To remove the module, use a flat blade screwdriver to move the latch, pull it out from the right side, and remove it from the left side.

- 4 Wire the module according to the wiring diagrams in the *8-Channel Relay Switch Wiring Guide* and the reports from Composer Pro.

- At the terminal block side, strip the wires 0.35 in. (9 mm) and tighten to 7 in. lbs. (0.8 Nm).
- At the module side, strip the wires 0.4 in. (10 mm) and insert into the push block terminal.

Note: All wires between the terminal block and the 8-Channel Relay Switch must use the same gauge wire as the field wiring connected to the terminal block.

- 5 On the right side of the 8-Channel Relay Switch, connect the Ethernet Cat5 cable to one of the RJ-45 ports. (The second port can be used to daisy-chain to another 10/100 Ethernet device).

- 6 Install the other modules in the panel as defined in the Panel Reports from Composer Pro and their respective installation and wiring guides.

- 7 Turn the circuit breakers back on and test all connected loads by pressing the channel override buttons.

Installing the module horizontally in a third-party panel

Third-party DIN rails can be mounted in any orientation; however, these instructions assume a horizontal orientation.

- 1 With the gray push terminals facing down, hold the 8-Channel Relay Switch lengthwise and angle it down so that the bottom side of the module fits onto the rail (see Figure 4).

Note: The 8-Channel Relay Switch installs with the Line Voltage Connectors facing down and the Ethernet ports facing up.

Figure 4. Attach the 8-Channel Relay Switch - third-party panels

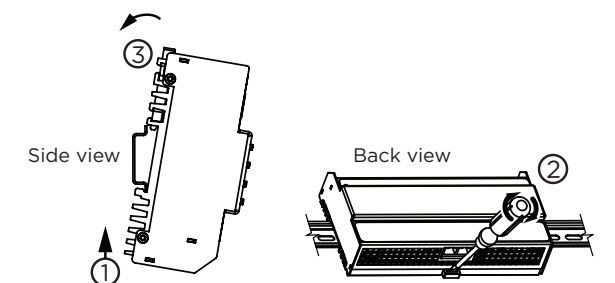

- 2 With the bottom side already in place, use a flat blade screwdriver to move the latch.

- 3 While rotating it upward, release the latch to secure it onto the rail.

 **Note:** To remove the module, use a flat blade screwdriver to move the latch, pull it out from the top, and remove it from the bottom rail.

- Wire the module according to the wiring diagram in the *8-Channel Relay Switch Wiring Guide* and the reports from Composer Pro.

Strip the wires 0.4 in. (10 mm) and insert into the push block terminal.
- On the top of the 8-Channel Relay Switch, connect the Ethernet CAT5 cable to one of the RJ-45 ports. (The second port can be used to daisy-chain to another 10/100 Ethernet device).
- Install the other modules in the panel as defined in their respective installation guides.
- Turn the circuit breakers back on and test all connected loads by pressing the channel override buttons.

Wiring diagrams

The wiring diagrams show the wiring details for Control4 8-Channel Relay Switches. Refer to the *8-Channel Relay Switch Wiring Guide* (ctrl4.co/8chrelay-wiring) to view those diagrams.

Operation and configuration

Composer Pro configuration and reports

Use Composer Pro to define the properties of each 8-Channel Relay Switch, its location in a panel, and the loads that are connected to it. Composer Pro can then be used to generate Panel Reports, Module Reports, and Load Schedule Reports. These reports are essential to ensuring that each 8-Channel Relay Switch is properly installed in the correct location and wired to the appropriate loads. Please refer to the *Composer Pro User Guide* for detailed information.

LEDs

The indicator lights on the front of the 8-Channel Relay Switch communicate the status of the device.

| Indicator | LED color | Status | Notes |
|-----------------|----------------|----------------------------|---|
| Module Override | Blue | Power on, normal operation | |
| | Black | Off | |
| | Red | Thermal overload | See "Faults" section below |
| Channels | Blue | Load on | |
| | Black | Load off | |
| | Yellow | Over-Wattage Fault | See "Faults" section below |
| | Cyan | No Power On Phase Fault | " |
| | Flashing green | Firmware updating | |
| | Green | Firmware update complete | |
| Link/Activity | Green | Link | |
| | Orange | Activity | |
| | Flashing green | Firmware updating | Flashing gets faster as update proceeds |
| | Flashing red | No link | |

Channel and Module Override buttons

During normal operation, buttons on the front of the Relay behave as follows:

| Button | Action | Result |
|-----------------|-----------------------|---|
| CH1-CH8 | Click | Toggles the load on and off. |
| Module Override | Click | Toggles between the module override scene and all channels off. |
| | Hold for five seconds | Sets the module override scene to current channel on/off settings. The Module Override LED will blink rapidly to indicate that the override scene has been saved. |

The following button tap sequences are available using the CH1 and CH8 buttons:

| Function | CH1 | CH8 | CH1 |
|---------------|-----|-----|-----|
| Identify | 4 | | |
| Reboot device | 15 | | |
| Factory reset | 9 | 4 | 9 |

Panelized Interlock feature

The Panelized Interlock feature improves compatibility with dual-relay blind motors. It allows the configuration of pairs of channels in interlocking mode so that both channels cannot be on at the same time, preventing accidental motor damage.

- To configure the 8-Channel Relay Switch, simultaneously press and hold channels 1 and 8.

 **Note:** If pressing 1 and 8 together does not enter the configuration mode, you will need to do a factory reset (as described above).

- All channel LEDs illuminate.

- A green LED indicates that the channel is in normal individual mode. Flashing yellow LEDs indicate that the two channels are in interlock mode.
- To change the mode, press the Channel button for one of the channels.

 **Note:** You cannot pair any two random channels together.
Note: Interlocking will only work on adjacent channels in odd/even pairs, i.e. 1:2, 3:4, 5:6, and 7:8.

- To exit the setup, press and hold the **Module Override** button.

Reset button

A single press of the Reset button is equivalent to powering the 8-Channel Relay Switch off and back on. Additionally, certain special activities can be accomplished by pressing and holding a specific button while also pressing the Reset button. Note that the same activity is possible by pressing and holding the designated button while power cycling the 8-Channel Relay Switch:

 **Note:** The Reset button is recessed and must be pressed using a paperclip or similar device.

| Hold button while pressing Reset | Result |
|----------------------------------|---|
| CH7 | Disables DHCP and forces the IP address to 192.168.1.200 |
| CH8 | Toggles between Enable/Disable DHCP |
| Module Override | Restores the factory defaults (do not perform unless directed to do so by Control4 Technical Support) |

Overtemp fault

- Occurs if the module reaches an unsafe operating temperature.
 - All loads attached to the module turn off.
 - The Module Override LED turns red.
 - The fault condition cannot be cleared and loads cannot be turned back on until the device has reached a safe operating temperature. When the device has reached a safe operating temperature, the fault will automatically clear.
-  **Note:** Loads will not automatically turn back on after the fault has cleared.

Over-wattage fault

- Occurs if the current is over the allowed individual channel threshold of 16A for 10 seconds.
- The load attached to the faulted channel will turn off.
- The channel LED will turn yellow.
- To clear the fault, simply turn the load back on via the appropriate channel button on the front of the module or via a keypad (or any other action) that has been programmed to control the load. The fault can also be cleared by pressing and holding the channel button for five (5) seconds. Composer Pro can also be used to clear the fault.

No power on phase fault

- Occurs if there is no zero cross detected on Line 2-4 or Neutral 2-4.
- The channel LEDs will turn solid cyan on channels with unconnected Line or Neutral.
- The fault condition cannot be cleared until Line 2-4 and Neutral 2-4 are connected to the product.

Phase fault

- Occurs if all Line-Ins are not the same phase.
- All channel LEDs will blink white.

Manual overrides

Prior to installation of the control system, or in case a problem occurs with the control system or the network, it is possible to control the loads attached to the 8-Channel Relay Switch several ways:

- Override scene
 - The module override scene is stored in the module itself and does not require interaction from the control system.
 - The default setting for this override scene is *all loads on*.
 - The override scene settings can be changed using the buttons on the front of the module (see the "Channel and Module Override buttons" section above) or Composer Pro.
- Module Override button
 - Pressing the Module Override button toggles the attached loads between the stored override scene and *all loads off*.
- Auxiliary Override contacts
 - The Aux In and Aux Out terminals on the 8-Channel Relay Switch can be wired to a standard line-voltage toggle switch installed in a hidden but convenient location, such as a closet.
 - Each time the attached switch is flipped, the 8-Channel Relay Switch toggles between the stored override scene and *all loads off*.
 - If desired, a single toggle switch can be wired to the Aux In contact on multiple Control4 Centralized Lighting modules, but all modules sharing an auxiliary override switch *must be on the same electrical phase and voltage*.
 - The desired location of the Auxiliary Override switch can be defined in Composer Pro for each module. This information will appear in the Module Report generated by Composer Pro.
- Channel Override buttons
 - The Channel Override buttons on the front of the module provide individual control of each load attached to the 8-Channel Relay Switch. Press the specific Channel Override button to toggle the load on/off.

Troubleshooting

| Symptom | Possible Solution |
|--------------------------|--|
| Module does not power on | Verify that the circuit breaker is on. |
| | Verify that Line 1 in is connected to the power. |
| Load does not turn on | Verify that the load is wired to the proper channel terminal. |
| | Verify that all line inputs on the module (Line 1, 2, 3, and 4) are all receiving power. |
| | Verify that the light bulb is not burned out. |
| Loads do not turn off | Verify that the terminal block jumpers that connect the black terminal block to the red terminal blocks have been removed. |
| Module overheats | Verify that the module is receiving proper ventilation. |

Warranty and legal information

Find details of the product's Limited Warranty and other safety, patent, and legal resources at snapone.com/legal or request a paper copy from Customer Service at [866.424.4489](tel:866.424.4489).

More information

For the latest version of this guide and to view additional materials, open the URLs below or scan the QR code. Your device must be able to view PDFs.

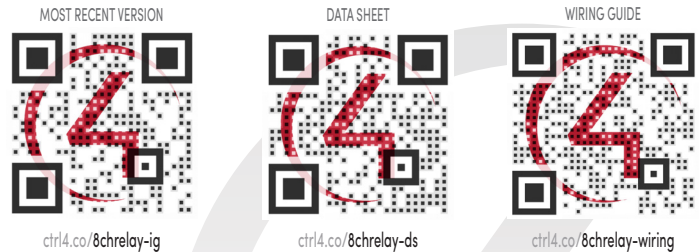

control4.com | 888.400.4070

Copyright ©2021, Snap One, LLC. All rights reserved. Snap One and its respective logos are registered trademarks or trademarks of Snap One, LLC (formerly known as Wirepath Home Systems, LLC), in the United States and/or other countries. Control4, SnapAV, and Wirepath are also registered trademarks or trademarks of Snap One, LLC. Other names and brands may be claimed as the property of their respective owners. Snap One makes no claim that the information contained herein covers all installation scenarios and contingencies, or product use risks. Information within this specification subject to change without notice.

