

## Square Wireless Switch Installation Guide





Environmental	
Operational temperature	0°C - 40°C (32°F - 104°F)
Humidity	5% to 95% non-condensing
Storage	-20°C - 70°C (-4°F - 158°F)
Miscellaneous	
Control communications	ZigBee, IEEE 802.15.4, 2.4 GHz, 15-channel spread spectrum radio
Wires per connector	One 0.5 mm <sup>2</sup> - 2.5 mm <sup>2</sup> OR Two 0.5 mm <sup>2</sup> - 1.5 mm <sup>2</sup>
Dimensions	83 × 71 × 33 mm (3.3 × 2.8 × 1.3 in)
Depth in wall box	25.8 mm (1.0 in)
Weight	0.08 kg (2.8 oz)
Shipping weight	0.14 kg (4.9 oz)

### Introduction

The Control4® Square Wireless Switch operates independently or as part of a Control4 home automation system. It installs in a standard square (UK/China-style) or round (EU-style) wall box using typical wiring standards and communicates to the Control4 system using a wireless connection.

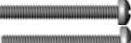









### Box contents

- Square Wireless Switch
- *Square Single-Load Switch Installation Guide* (this document)
- M3.5 machine screws (2) 
- M4.0 machine screws (2) 
- M3.0 thread-cutting screws (2) 

### Specifications and supported load types

Model numbers	C4-SSW240-N
Power requirements	220VAC-240VAC +/-10%, 50/60 Hz This device requires a neutral connection.
Power consumption	950mW
Load types and ratings	
Supported load types	Incandescent, halogen, electronic (solid state) low-voltage (ELV) transformer, magnetic (iron core, inductive) low-voltage (MLV) transformer, compact fluorescent, LED, and motor.
Maximum load	
Incandescent (tungsten)	4A
Halogen	4A
Fluorescent	3A
Compact fluorescent (CFL)	3A
LED	1A
Motors	1/8 HP

### Warnings and considerations

-  **WARNING!** Turn OFF electrical power before installing or servicing this product. Improper use or installation can cause SERIOUS INJURY, DEATH or LOSS/DAMAGE OF PROPERTY.
-  **WARNING!** This device must be protected by a circuit breaker (20A max).
-  **IMPORTANT!** This device must be installed by a licensed electrician in accordance with all national and local electrical codes.
-  **IMPORTANT!** When installing the switch in an EU-style (round) wall box, a trim ring (sold separately) must be installed between the switch and the wall box. Trim rings are available in both single-gang and dual-gang versions.
-  **IMPORTANT!** This device must be attached to the wall box with screws. Wall boxes without screw holes for mounting (for example, those that require expansion clamps) are not compatible with this device.
-  **IMPORTANT!** Use this device only with copper or copper-clad wire. Do not use aluminum wiring. This product has not been approved for use with aluminum wiring.
-  **IMPORTANT!** To reduce the risk of overheating and possible damage to other equipment, do not install to control a receptacle or a motor operated appliance.
-  **IMPORTANT!** Using this product in a manner other than outlined in this document voids your warranty. Further, Control4 is NOT liable for any damage incurred with the misuse of this product. See "Troubleshooting."
-  **IMPORTANT!** Do NOT use a power screwdriver to install this device. If you do, you may overtighten the screws and strip them. Also, overtightening the screws may interfere with proper button operation.
-  **IMPORTANT!** This is an electronic device with intricate components. Handle and install with care!
-  **IMPORTANT!** Control4 does not guarantee the performance of any bulb or lamp/fixture in your environment. CUSTOMER ASSUMES ALL RISKS, INCLUDING ANY DAMAGE TO CONTROL4 PRODUCTS, ASSOCIATED WITH (i) THE TYPE, LOAD RATING AND QUALITY OF THE BULB AND LAMP/FIXTURE, OR (ii) ANY USE OR INSTALLATION NOT IN ACCORDANCE WITH THE DOCUMENTATION FURNISHED BY CONTROL4, EITHER WITH THE CONTROL4 PRODUCT OR AT WWW.CONTROL4.COM.

## Installing the switch

- 1 Ensure that the location and intended use meet the following criteria:
  - Do not exceed the load capacity requirements of the switch. Refer to the load ratings in the specifications above for details.
  - Install in accordance with all national and local electrical codes.
  - The range and performance of the wireless control system is highly dependent on the following: (1) distance between devices; (2) layout of the home; (3) walls separating devices; and (4) electrical equipment located near devices.
- 2 Turn off the mains electrical power at the consumer unit. To ensure the wires do NOT have power running to them, use an inductive voltage detector.
- 3 Determine whether the switch will be installed in a UK-style (square) or EU-style (round) wall box. If the switch is to be installed in an EU-style (round) wall box, ensure that the appropriate trim ring (sold separately) is available before proceeding.
- 4 Prepare each wire. Wire insulation should be stripped back 7mm from the wire end.
- 5 If installing in a round wall box, pull the wires through the center hole in the trim ring. The arrows on the trim ring should face forward and up.
- 6 Identify your wiring application, and then see the appropriate wiring diagram in the “Sample wiring configurations” section below.
- 7 Connect the switch to the wall box wires as shown in the applicable wiring diagram.
- 8 Fit the wires into the wall box.
- 9 Follow the appropriate instructions for attaching the switch:

### To install in a square (UK/China-style) wall box:

- a Align the switch to the wall box as shown in Figure 1 (note the **UP** orientation arrow on the switch), then fasten the switch to the wall box using the included M3.5 machine screws (UK-style wall box) or M4.0 machine screws (China-style wall box).

**Figure 1: Square wall box installation**



### To install in an EU-style round wall box with mounting screws on the left and right:

- a Align the switch and the trim ring to the wall box as shown in Figure 2 (note the **UP** orientation arrow on the trim ring and switch).
- b Fasten the switch and trim ring to the wall box using either the included M3.0 thread cutting screws or the screws that came pre-installed in the wall box. Note that some pre-installed screws may not have large enough screw heads to securely hold the switch.

**Figure 2: Round wall box installation—horizontal screw holes**

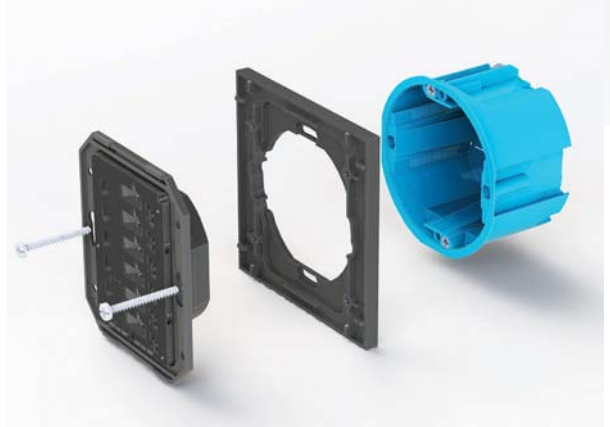

### To install in an EU-style round wall box with mounting screws on the top and bottom:

- a Align the trim ring to the wall box as shown in Figure 3 (observe the **UP** orientation arrow on the trim ring).
- b Fasten the trim ring to the wall box using either the included M3.0 thread cutting screws or the screws that came pre-installed in the wall box. Note that some pre-installed screws may not have large enough screw heads to securely hold the trim ring.
- c Attach the switch to the trim ring with four M2.2 x 6 mm thread-forming screws included with the trim ring as shown in Figure 3.

**Figure 3: Round wall box installation—vertical screw holes**



 **Note:** For instructions on installing in a dual EU-style wall box with a dual trim ring, refer to the *Dual Trim Ring Installation Guide*.

 **IMPORTANT!** Tighten the screws until the device or trim ring is flush with the wall surface, but no further. Overtightening can warp the switch and cause it to malfunction.

- 10 Attach the buttons as described in the *Keypad Button Installation Guide*.
- 11 Install the Control4 Faceplate (sold separately) by placing the top of the faceplate on the device (note the **UP** orientation arrow on the inside of the faceplate) and firmly pressing the bottom until the faceplate snaps into place against the wall.

 **Note:** To remove the faceplate, use a flathead screwdriver. Insert the screwdriver into the small gap on the bottom between the faceplate and the device, then twist the screwdriver blade to pop the faceplate off.

- 12 Turn ON mains electrical power at the consumer unit.

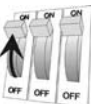

## Operating the switch

On initial power up, all status LEDs on the switch will illuminate green, indicating that the device has power. To set up this switch for use with a Control4 system, refer to the *Composer Pro User Guide* ([ctrl4.co/cpro-ug](http://ctrl4.co/cpro-ug)).

### To operate this switch as a stand-alone device:

- If the light is off, press any button to turn the light on.
- If the light is on, press any button to turn the light off.



**Note:** If the switch is configured with a rocker-style button, both the top and bottom rocker buttons will toggle the load. The device will need to be configured in Composer Pro for the top button to turn the load on and the bottom button to turn the load off.

## Button tap sequences

The button tap sequences are defined in the table below. Button tap sequences that require a single button should use the top-most button installed on the switch. Button tap sequences requiring two buttons should use the top-most and bottom-most buttons installed on the switch.

Function	Button tap sequence
Identify	4
ZigBee channel	7
Reboot	15
Factory reset	9-4-9
Leave mesh and reset	13-4-13

## Troubleshooting

### If the light does not turn on:

- Ensure that at least one LED on the face of the switch is lit.
- Ensure that the light bulb is not burned out and is screwed in tightly.
- Ensure that the circuit breaker is not turned OFF or tripped.
- Check for proper wiring (see "Sample wiring configurations"). If the Line and Neutral wires are reversed, the light will be one while the switch is off, and vice versa.
- If the light turns on when it should be off and turns off when it should be on:
  - Note that, in the default configuration, all buttons will toggle the light, even when a rocker button is installed on the device.
  - Ensure that the *Line* and *Neutral* connections are not reversed.
- For help on the installation or operation of this product, email or call the Control4 Technical Support Center. Please provide your exact model number. Contact [support@control4.com](mailto:support@control4.com) or see the web site [www.control4.com](http://www.control4.com).

## Care and cleaning

- Do NOT paint the switch or its wall plate.
- Do NOT use any chemical cleaners to clean the switch.
- Clean surface of the switch with a soft damp cloth as needed.

## Additional resources

### The following resources are available for additional support:

- Control4 Knowledgebase and forums
- Control4 Technical Support
- Control4 website: [www.control4.com](http://www.control4.com)
- Composer documentation available at [ctrl4.co/docs](http://ctrl4.co/docs).

For the latest version of this document, open this URL or scan the QR code on a device that can view PDFs.



## Regulatory/Safety information

To review Regulatory information for your particular Control4 products, see the information located on the Control4 website at [ctrl4.co/reg](http://ctrl4.co/reg).

## Patent information

Applicable patents are available at [ctrl4.co/patents](http://ctrl4.co/patents).

## Warranty

Visit [ctrl4.co/warranty](http://ctrl4.co/warranty) for details.

## Sample wiring configurations

Figure 4: Single device location

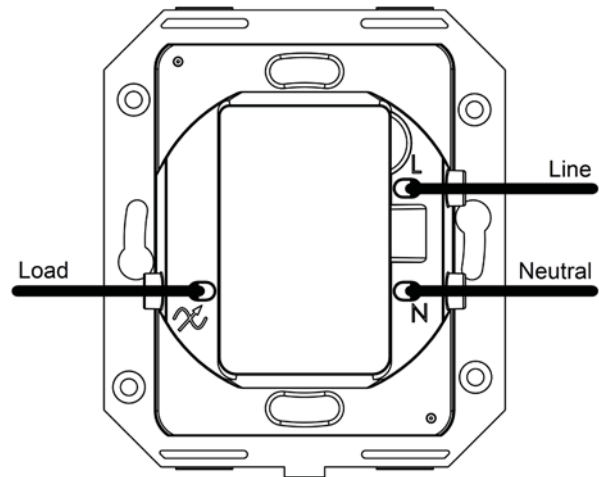
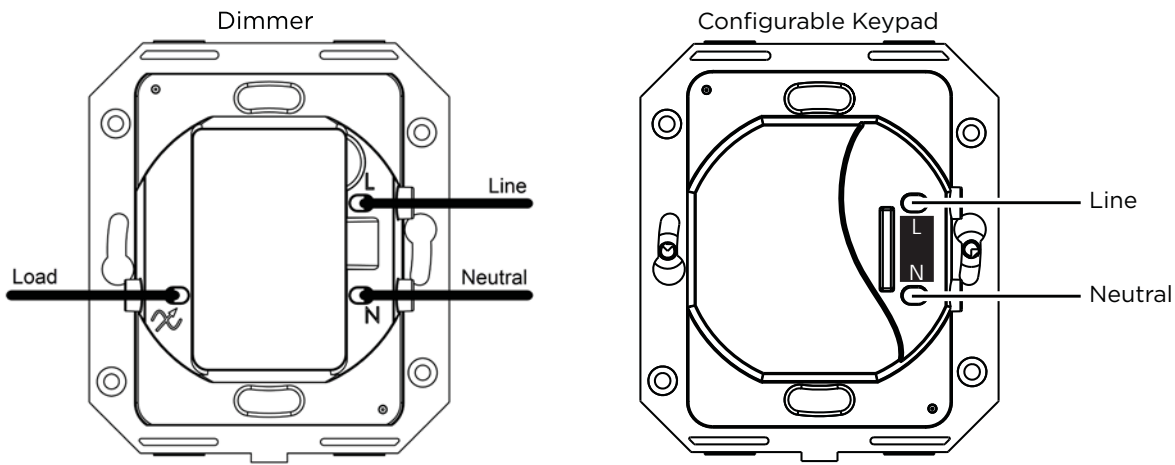

Figure 5: Multiple device locations using Configurable Wireless Keypad



Control4®

control4.com | 888.400.4070

Copyright ©2016, Control4 Corporation. All rights reserved. Control4, the Control4 logo, the 4-ball logo, 4Store, 4Sight, Control4 My Home, and Everyday Easy are registered trademarks or trademarks of Control4 Corporation in the United States and/or other countries. All other names and brands may be claimed as the property of their respective owners. All specifications subject to change without notice.