

HomeWorks QS Wired Palladiom Keypad

The HomeWorks QS wired Palladiom keypad allows the user to control lights, shades/ draperies, temperature, and 3rd-party equipment. The keypad is wired to a HomeWorks QS processor on the QS link.

Large buttons are easy to use and button engraving is easy to read. Buttons with white, backlit engraving make it easy to find and operate the keypad in low light conditions. Keypads are available in a variety of colors, finishes, and button marking options.

Status of active button press or scene is indicated through intensity of backlighting which is configurable through the HomeWorks QS software. Dynamic Backlighting Management (DBM) automatically adjusts backlight intensity based on ambient lighting conditions. It can also be programmed in the HomeWorks QS software to adjust intensity by time of day or button presses.

Model Numbers

See [How to Build a Model Number \(Keypads\)](#).

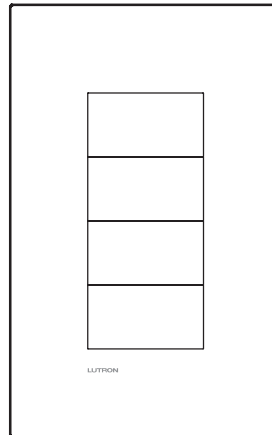

1-Gang U.S. Style

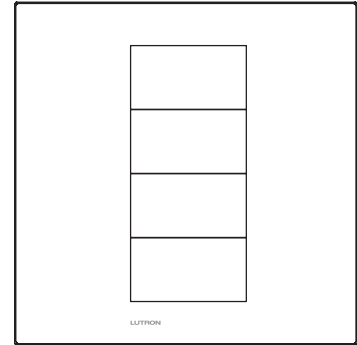

1-Column Square Style

HomeWorks QS Wired Palladiom Keypad

Specifications

Model Numbers	See How to Build a Model Number (Keypads) .
Power	24–36 V $\overline{=}$ 30 mA
Typical Power Consumption	0.7 W <i>Test conditions:</i> all backlights on medium intensity, two LEDs on (two presets active), keypad powered at 24 V $\overline{=}$
Regulatory Approvals	Lutron Quality Systems registered to ISO 9001:2015. Complies with UL 508; IEC 60669-2-1; and CSA C22.22 No. 14-13. EBB-1-3COL only - Complies with UL 2269; IEC 60670-1; and CSA C22.22 No. 18.2 (2006).
Environment	<i>Ambient operating temperature:</i> 32 °F to 104 °F (0 °C to 40 °C), 0% to 90% non-condensing relative humidity. Indoor use only.
Communications	SELV/PELV/NEC® Class 2 wiring connects keypads to other devices on the QS link. Each keypad counts as 1 device on the QS link. Each keypad column consumes 1 Power Draw Unit (PDU) on the QS link. For complete information, see “Power Draw Units on the QS link” (Lutron P/N 369405).
ADA Standard	Control operation complies with ADA standards for an accessible design.
ESD Protection	Meets IEC 801-2. Tested to withstand 15 kV electrostatic discharge without damage or memory loss.
Power Failure	<i>Power failure memory:</i> should power be interrupted, the keypad will return to its previous state when power is restored.
Mounting	<i>Typical U.S. style wallbox dimensions:</i> 3.7 in (95 mm) H × 1.8 in (46 mm) W × 2.8 in (70 mm) D. <i>Typical square style wallbox dimensions:</i> 75 mm H × 75 mm W × ≥ 25 mm D. <i>Typical round style wallbox dimensions:</i> ϕ 68 mm × ≥ 25 mm D. See Mounting on page 11 for more details.
Wiring	SELV/PELV/NEC® Class 2
Terminals	Each terminal accepts up to two 18 AWG (1.0 mm ²) wires.
Warranty	www.lutron.com/TechnicalDocumentLibrary/warranty.pdf www.lutron.com/TechnicalDocumentLibrary/Intl_warranty.pdf

Design Features

- Adjustable back-light intensity.
- Faceplate snaps on with no visible means of attachment.
- Use Faceplate or Button Kits to change color or engraving.
- Field-changeable button and faceplate assemblies allow for customization. See **How to Build a Model Number (Button Kits)** as some restrictions apply.
- IP20 Rating.

HomeWorks QS Wired Palladium Keypad

Dimensions

U.S. Style - Plastic, Glass, or Metal Finish

Measurements shown as: in (mm)

1-Gang

Front View

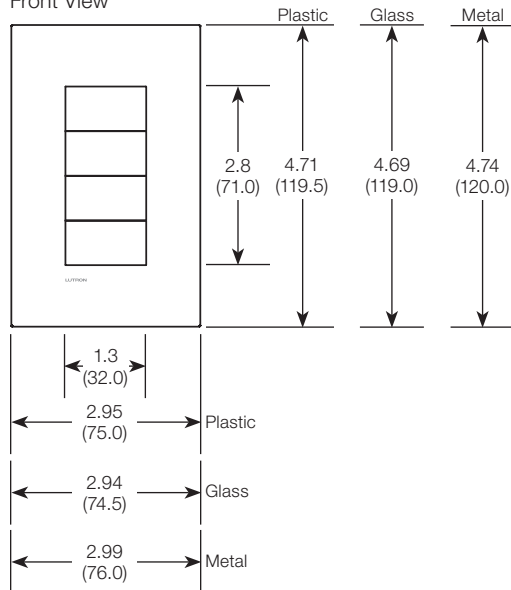

Side View

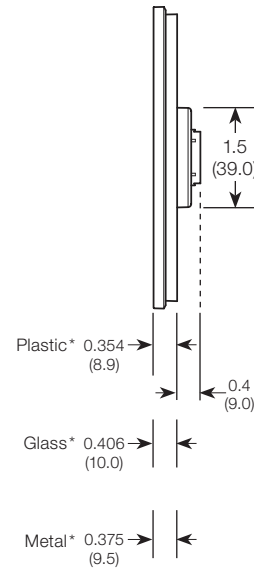

2-Gang

Front View

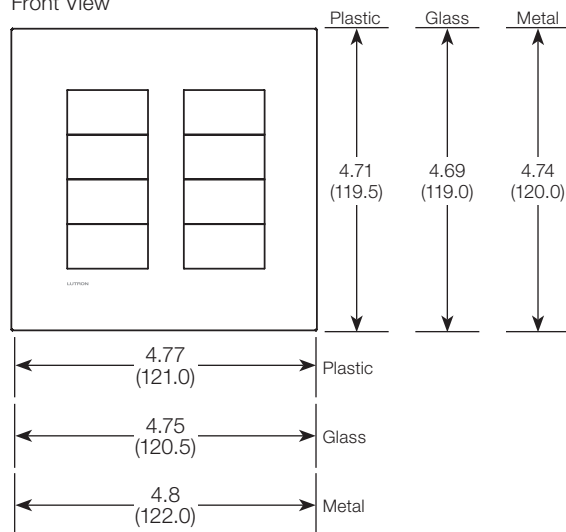

Side View

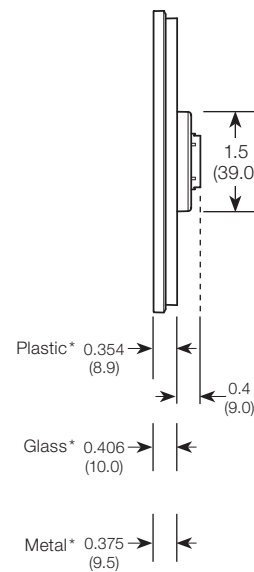

* Wallbox installation will affect this dimension.

(continued on next page...)

Customer Assistance:
1.844.LUTRON1 (U.S.A./Canada)
+44.(0)20.7680.4481 (Europe)

HomeWorks QS Wired Palladiom Keypad

Dimensions (continued)

U.S. Style - Plastic, Glass, or Metal Finish (continued)

Measurements shown as: in (mm)

3-Gang

Front View

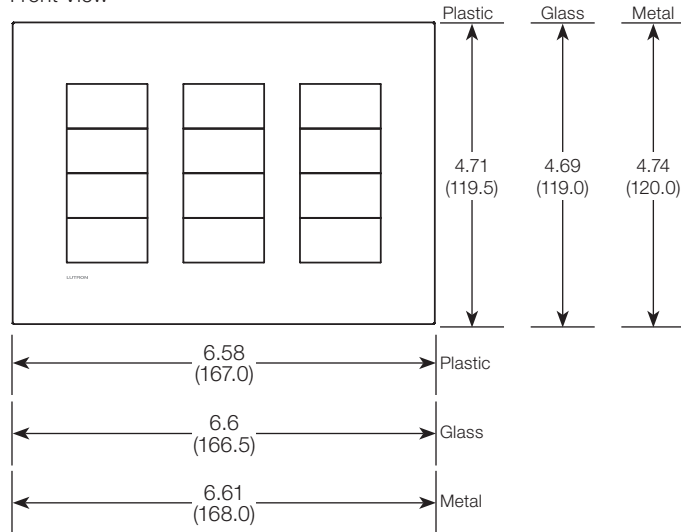

Side View

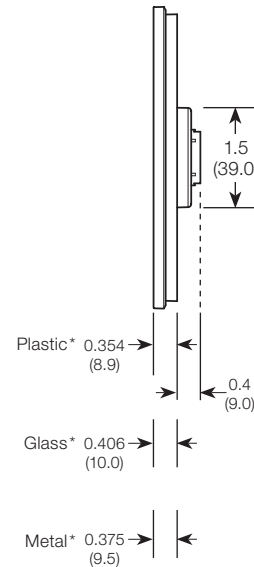

4-Gang

Front View

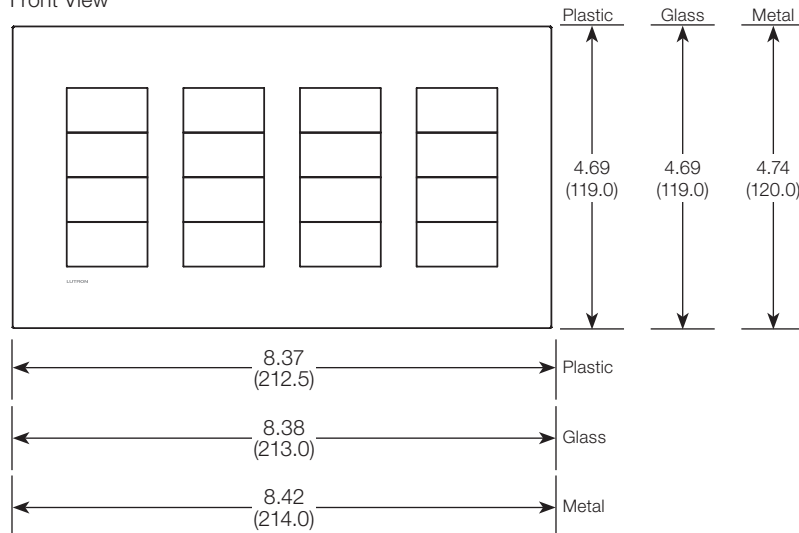

Side View

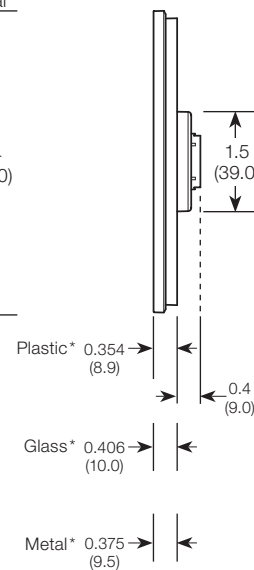

* Wallbox installation will affect this dimension.

HomeWorks QS Wired Palladiom Keypad

Dimensions *(continued)*

Square Style - Plastic, Glass, or Metal Finish

Measurements shown as: mm (in)

1-Column

Front View

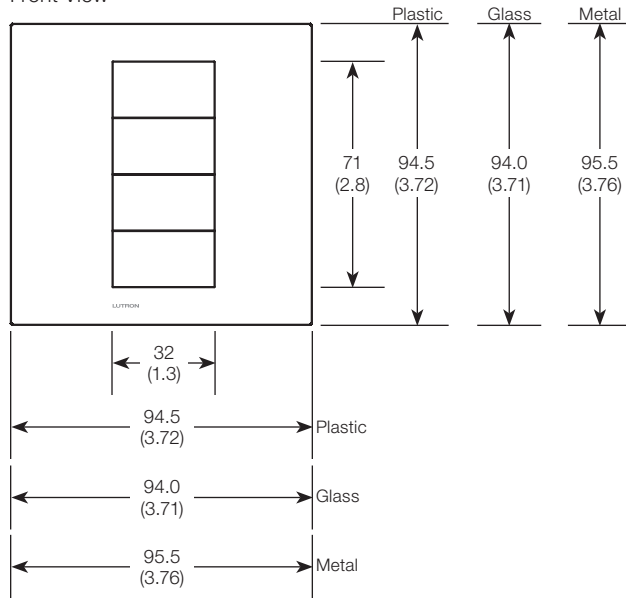

Side View

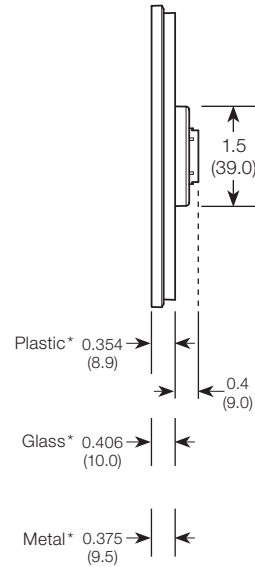

2-Column

Front View

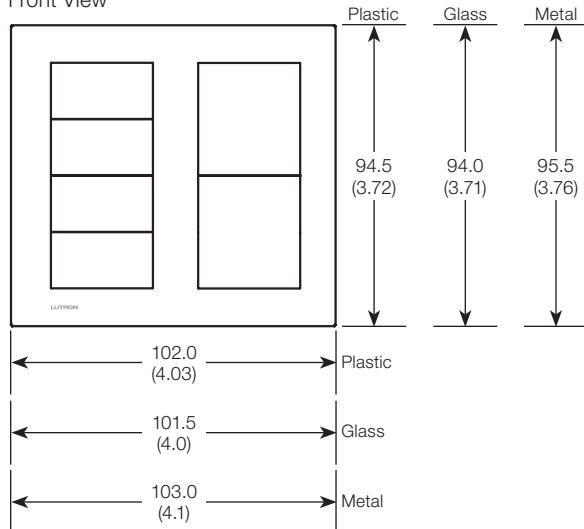

Side View

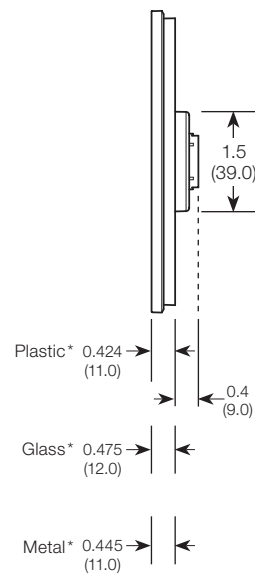

* Wallbox installation will affect this dimension.

HomeWorks QS Wired Palladiom Keypad

Dimensions *(continued)*

Square Style - Plastic, Glass, or Metal Finish *(continued)*

Measurements shown as: mm (in)

3-Column

Front View

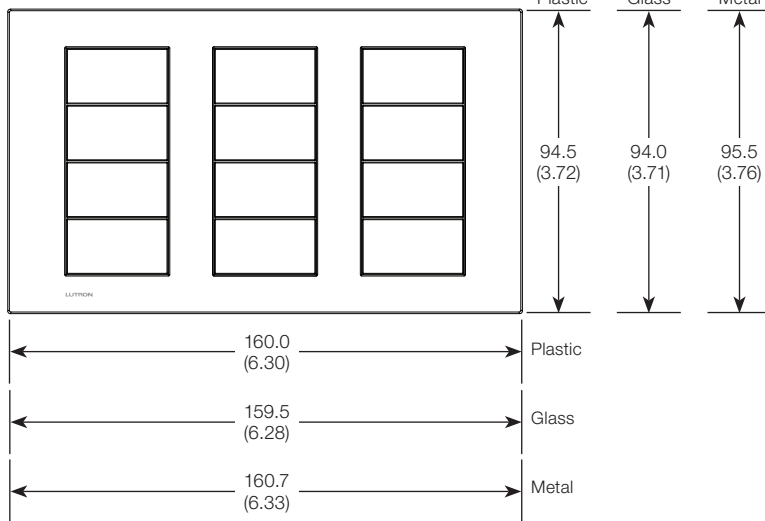

Side View

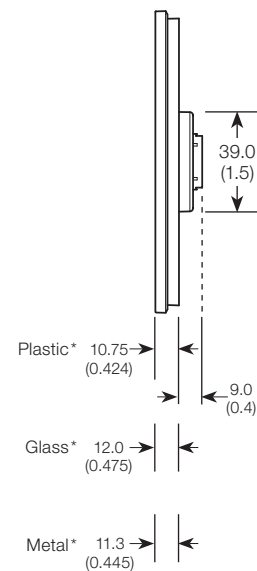

4-Column

Front View

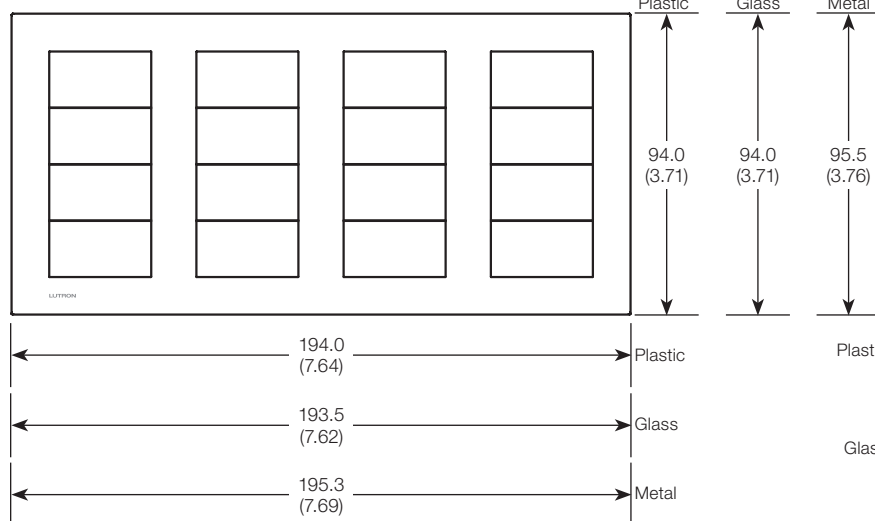

Side View

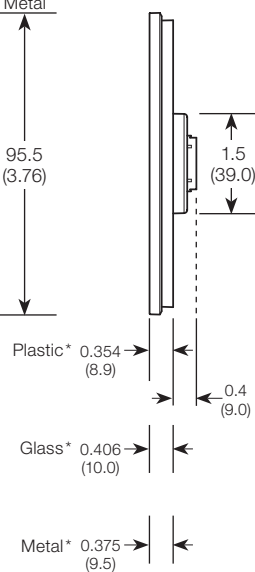

* Wallbox installation will affect this dimension.

HomeWorks QS Wired Palladiom Keypad

How to Build a Model Number

Keypads

HQWT – U – P2 W – WH – E

System Type

HQWT: HomeWorks QS

Faceplate Options

B: Base Unit without Faceplate*

U: U.S. Style

S: Square Style

* Base units are not interchangeable between plastic, metal, and glass.

Button Configurations

1-Gang/Column, U.S. or Square Style

P2: 2-Button

P3: 3-Button

P4: 4-Button

PR: 3-Button with Raise/Lower

2-Column Square Style

<i>Left Column</i>	<i>Right Column</i>
--------------------	---------------------

P22: 2-Button	2-Button
----------------------	----------

P24: 2-Button	4-Button
----------------------	----------

P2R: 2-Button	3-Button with Raise/Lower
----------------------	---------------------------

PR2: 3-Button with Raise/Lower	2-Button
---------------------------------------	----------

PRR: 3-Button with Raise/Lower	3-Button with Raise/Lower
---------------------------------------	---------------------------

P42: 4-Button	2-Button
----------------------	----------

P44: 4-Button	4-Button
----------------------	----------

P4R: 4-Button	3-Button with Raise/Lower
----------------------	---------------------------

PR4: 3-Button with Raise/Lower	4-Button
---------------------------------------	----------

Backlighting

W: White

Colors and Finishes

Architectural Matte Finishes

AL: Almond

BE: Beige

BL: Black

BR: Brown

GR: Gray

IV: Ivory

LA: Light Almond

SI: Sienna

TP: Taupe

WH: White

Architectural Metal Finishes

BB: Bright Brass

BC: Bright Chrome

BN: Bright Nickel

PG: Polished Graphite

QB: Antique Brass

SB: Satin Brass

SC: Satin Chrome

SN: Satin Nickel

Glass Finish

CBL: Clear Black Glass

CWH: Clear White Glass

Engraving

See **Engraving Options** for more details

Omit: Generic engraving and custom buttons*

E: Predefined custom engraving**

* Ships with engraving credit to allow future engraving.

** Customer must provide engraving details at time of order.

HomeWorks QS Wired Palladiom Keypad

How to Build a Model Number *(continued)*

Button Kits

Use Button Kits to change color, button configuration, and engraving. Each Button Kit includes a button assembly.

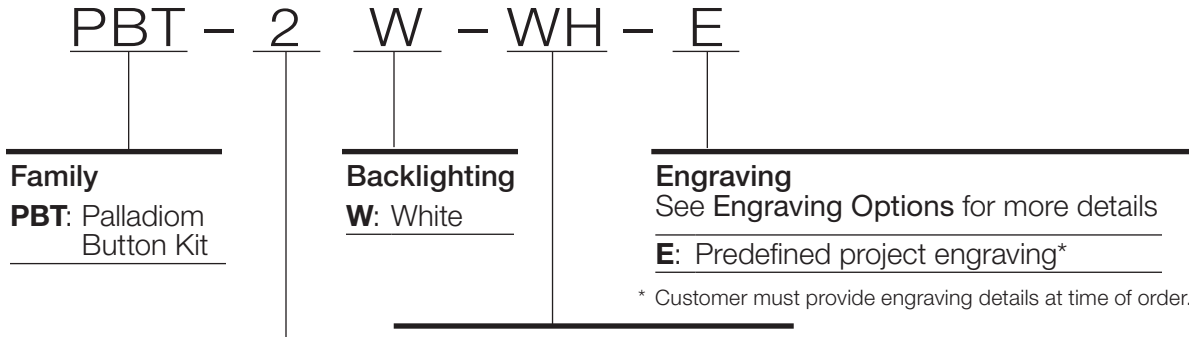

Button Configurations *1-Gang/Column, U.S. or Square Style*

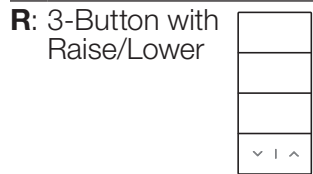
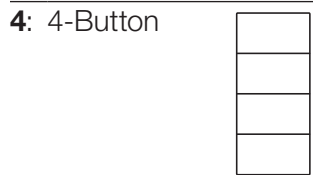
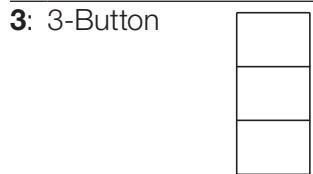
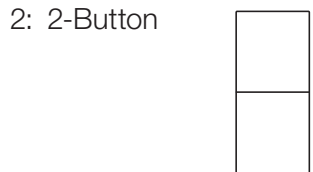

Colors and Finishes

Finishes for buttons and faceplates must always match (e.g., matte plastic buttons with matte plastic faceplate, metal buttons with metal faceplate).

Architectural Matte Finishes

- AL:** Almond
- BE:** Beige
- BL:** Black
- BR:** Brown
- GR:** Gray
- IV:** Ivory
- LA:** Light Almond
- SI:** Sienna
- TP:** Taupe
- WH:** White

Architectural Metal Finishes

- BB:** Bright Brass
- BC:** Bright Chrome
- BN:** Bright Nickel
- PG:** Polished Graphite
- QB:** Antique Brass
- SB:** Satin Brass
- SC:** Satin Chrome
- SN:** Satin Nickel

Glass Finish

- CBL:** Clear Black Glass
- CWH:** Clear White Glass

Field Changes

Button engraving changes

Any keypad can have its buttons swapped in the field to change the engraving (e.g., 2-Button swapped for engraved 2-Button).

Button configuration changes

For easy system configuration changes, a 3-Button with Raise/Lower may be swapped in the field for a 4-Button.

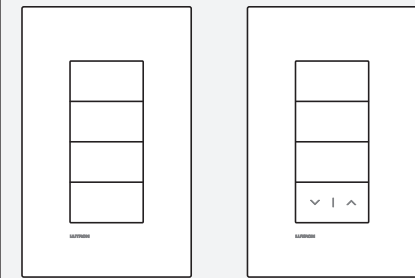

HomeWorks QS Wired Palladiom Keypad

How to Build a Model Number *(continued)*

Faceplate Kits

Use Faceplate Kits to change color and ganging. Each Faceplate Kit includes a faceplate adapter and faceplate.

LWT – U – P – WH

Family

LWT: Palladiom
Faceplate Kit

Faceplate Options

U: U.S. Style

S: Square Style

Gangs* and Openings

P:** Palladiom Keypad

* Palladiom Keypads do not gang with other devices of different sizes (e.g., Maestro or GRAFIK T controls).

** Repeat the letter designation "P" (4 maximum) for each opening (e.g., 1-gang = P, 2-gang = PP). See How to Select a Palladiom Keypad.

Colors and Finishes

Finishes for buttons and faceplates must always match (e.g., matte plastic buttons with matte plastic faceplate, metal buttons with metal faceplate).

Architectural Matte Finishes

AL: Almond

BE: Beige

BL: Black

BR: Brown

GR: Gray

IV: Ivory

LA: Light Almond

SI: Sienna

TP: Taupe

WH: White

Architectural Metal Finishes

BB: Bright Brass

BC: Bright Chrome

BN: Bright Nickel

SB: Satin Brass

SC: Satin Chrome

PG: Polished Graphite

QB: Antique Brass

SN: Satin Nickel

Glass Finish

CBL: Clear Black Glass

CWH: Clear White Glass

HomeWorks QS Wired Palladiom Keypad

Engraving Options

The Palladiom Keypad has engraving options ideal for many scenarios. The following information will help you determine which engraving option is best-suited to your needs.

Predefined Custom Engraving

Predefined project engraving is for instances when the customer knows the engraving details at the time of purchase and does not wish to order two sets of button kits. To select this option, use engraving option “E” when ordering the keypad.

Note: Orders cannot be processed until engraving information is received.

Generic Engraving and Post-Defined Custom Engraving

When engraving details are not known or specified at the time an order is placed, the generic engraving icons shown below will be sent to provide the customer with a usable keypad until the custom engraving details are determined. This keypad will be shipped with an engraving credit for ordering a custom-engraved button kit at a later time.

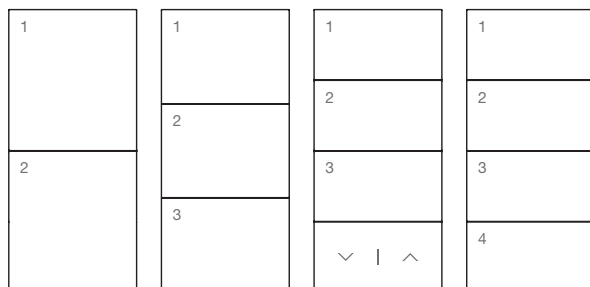

HomeWorks QS Wired Palladiom Keypad

How to Select a Palladiom Keypad

Examples of keypad and faceplate configurations are shown below.

U.S. Style

Model Number	Quantity	Assembled	Mount
1-Gang Keypad			
HQWT-U-P4W-WH	1	Yes	U.S. Wallbox

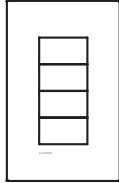

2-Gang Keypad			
HQWT-B-P4W-WH	2	No*	U.S. Wallbox
LWT-U-PP-WH	1		

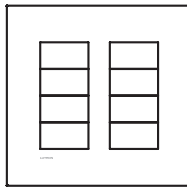

3-Gang Keypad			
HQWT-B-P4W-WH	3	No*	U.S. Wallbox
LWT-U-PPP-WH	1		

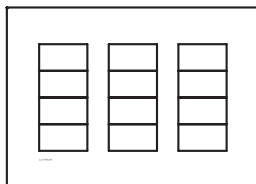

4-Gang Keypad			
HQWT-B-P2W-WH	4	No*	U.S. Wallbox
LWT-U-PPPP-WH	1		

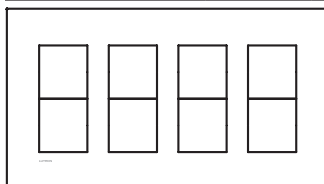

Square Style

Model Number	Quantity	Assembled	Mount
1-Column Keypad			
HQWT-S-P4W-WH	1	Yes	Square or Round Wallbox

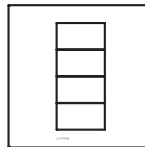

2-Column Keypad			
HQWT-S-P24W-WH	1	Yes	Square or Round Wallbox

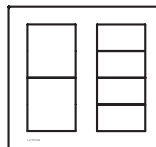

3-button configuration not available.

3-Column Keypad			
HQWT-B-P4W-WH	3	No*	EBB-1-3COL
LWT-S-PPP-WH	1		

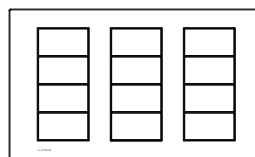

4-Column Keypad			
HQWT-B-P44W-WH	1	No*	2 Square or Round Wallboxes
HQWT-B-P22W-WH	1		
LWT-S-PPPP-WH	1		

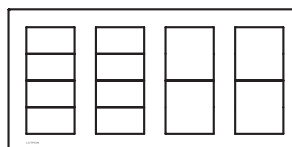

3-button configuration not available.

* Model numbers must be ordered as separate pieces and assembled. See **Keypad Assembly**.

HomeWorks QS Wired Palladiom Keypad

Keypad Assembly

Tools Required: Phillips head screwdriver (not included)

1. Place button kit on back of faceplate.
2. Align bulk unit over button kit and faceplate.
3. Assemble using 4 screws (provided).
4. Repeat steps 1–3 for each base unit.

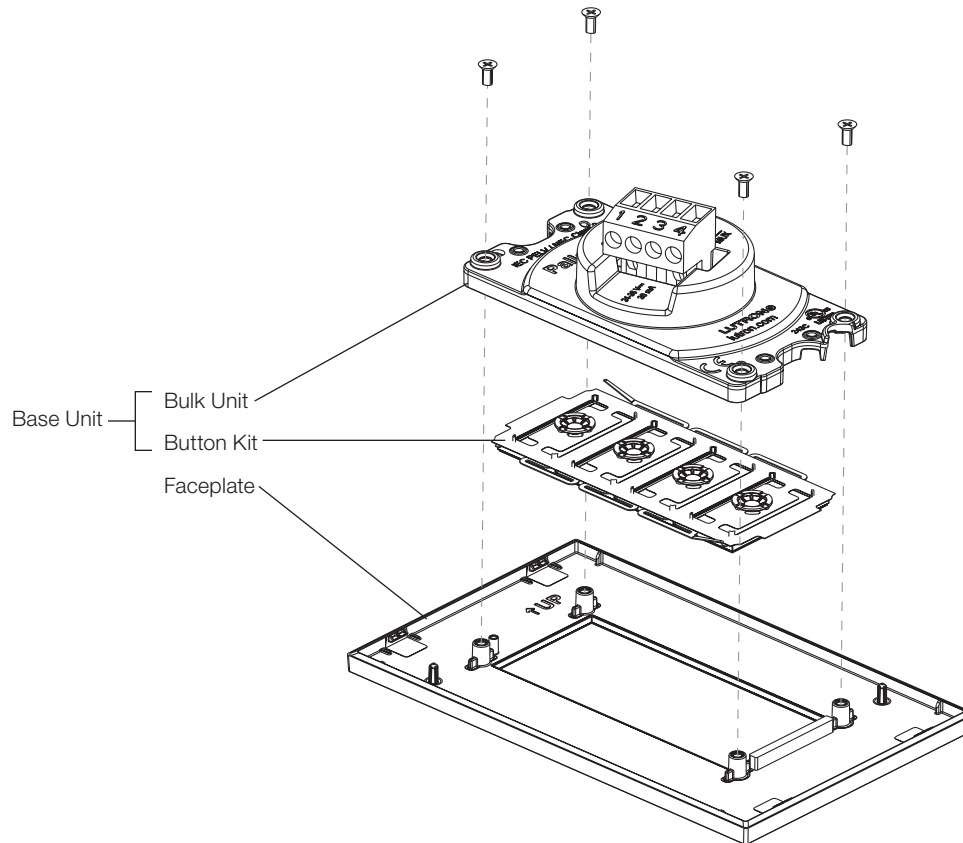

HomeWorks QS Wired Palladiom Keypad

Mounting

U.S. Style

1-Gang

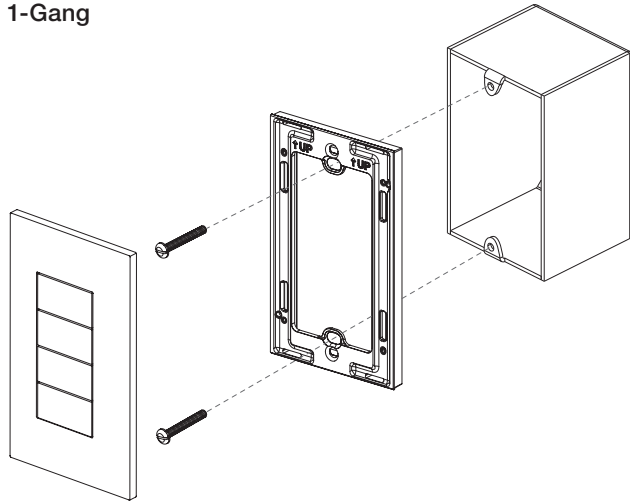

Back View

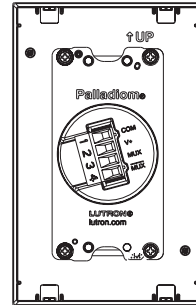

2-Gang

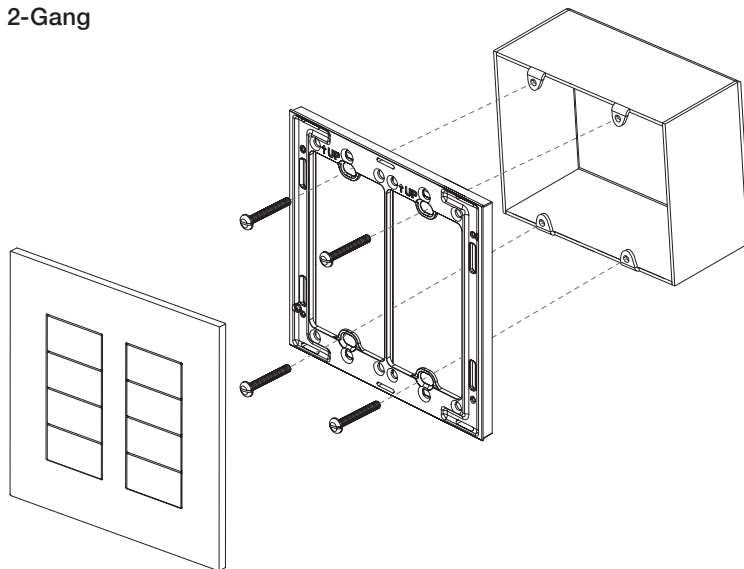

Back View

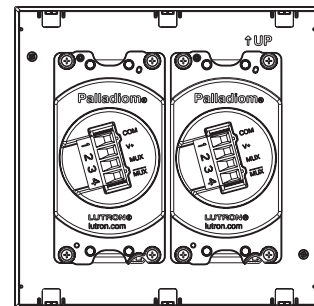

(continued on next page...)

Customer Assistance:
1.844.LUTRON1 (U.S.A./Canada)
+44.(0)20.7680.4481 (Europe)

HomeWorks QS Wired Palladiom Keypad

Mounting *(continued)*

U.S. Style *(continued)*

3-Gang

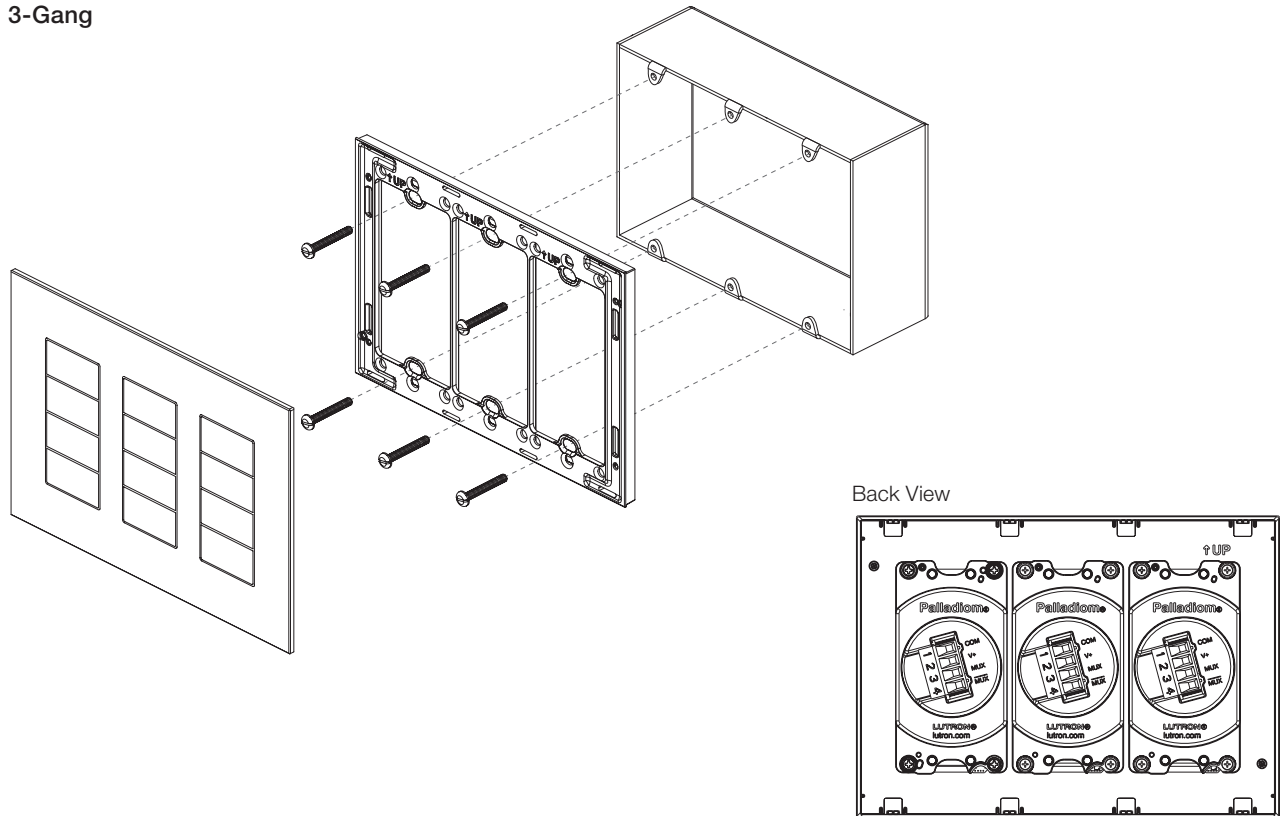

(continued on next page...)

Customer Assistance:
1.844.LUTRON1 (U.S.A./Canada)
+44.(0)20.7680.4481 (Europe)

HomeWorks QS Wired Palladiom Keypad

Mounting *(continued)*

U.S. Style *(continued)*

4-Gang

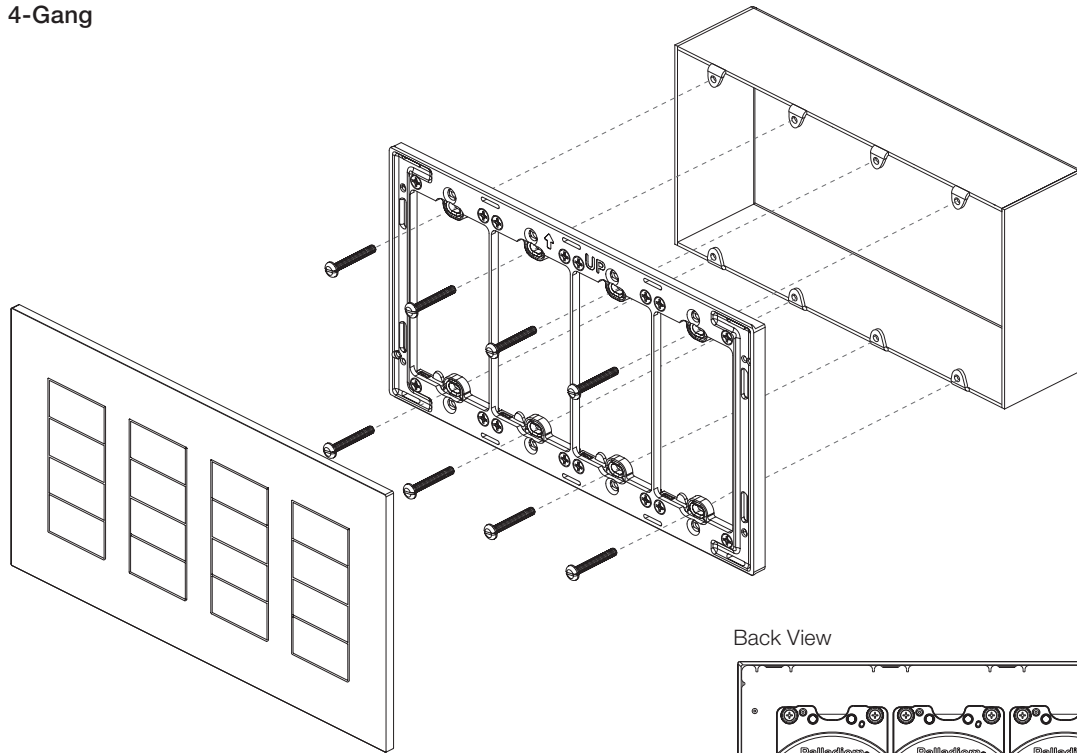

Back View

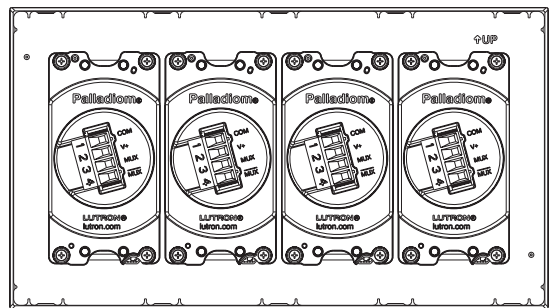

(continued on next page...)

Customer Assistance:
1.844.LUTRON1 (U.S.A./Canada)
+44.(0)20.7680.4481 (Europe)

HomeWorks QS Wired Palladiom Keypad

Mounting *(continued)*

Square Style (Square or Round Wallbox*)

1-Column

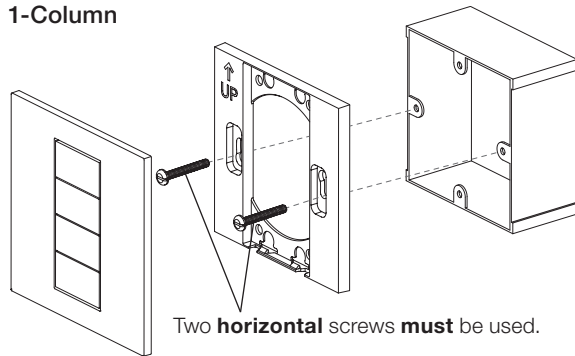

Back View

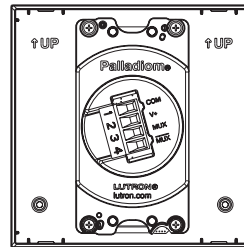

2-Column

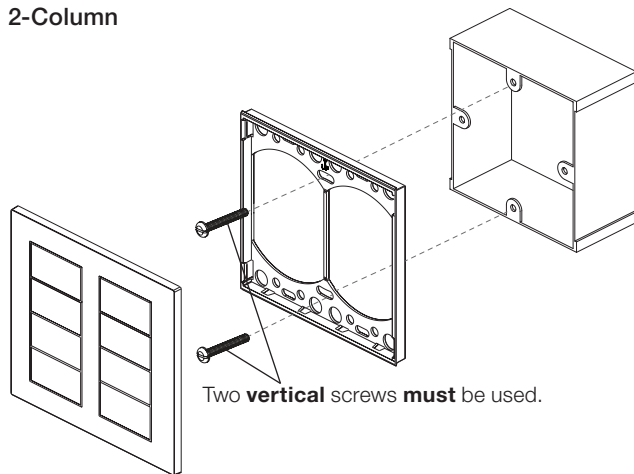

Back View

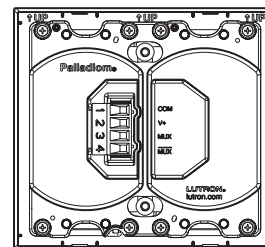

Note: 2-column base unit shown with 2-column faceplate.
1 + 1 keypad configuration will not fit with a U.K. or European backbox.

* Use wallbox with 4 available mounting screw holes for maximum flexibility.

(continued on next page...)

HomeWorks QS Wired Palladiom Keypad

Mounting *(continued)*

Square Style (Square or Round Wallbox) *(continued)*

3-Column^{1,2}

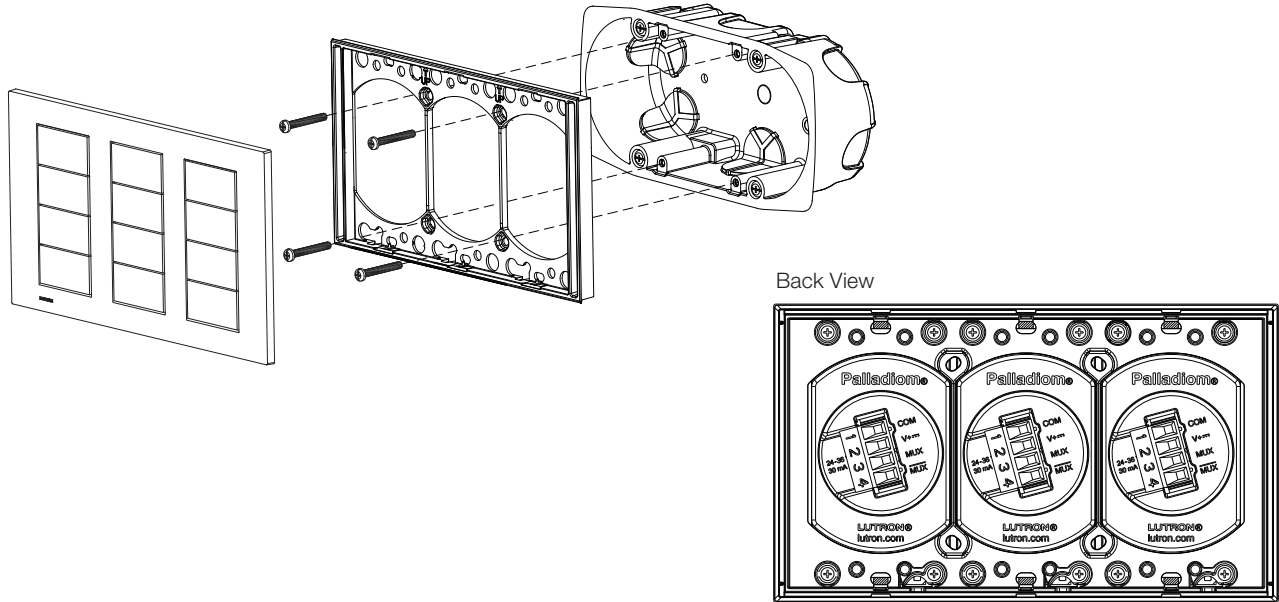

- ¹ Use Lutron part number EBB-1-3COL as wallbox for 3-Column wall installations.
- ² EBB-1-3COL is for hollow wall or plaster installations. Do not use for concrete pour installations. See Lutron App Note #705 (P/N 048705) at www.lutron.com for installation instructions.

4-Column*

Measurements shown as: mm (in)

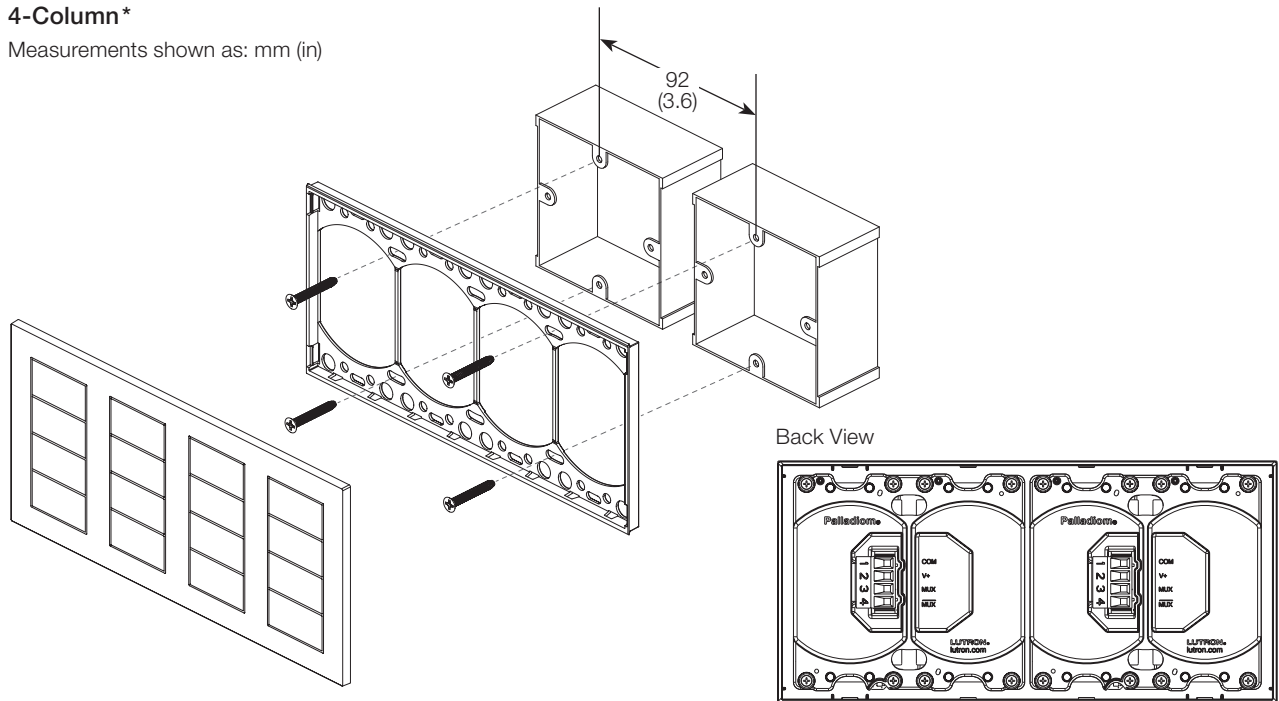

Note: Two 2-column keypads shown. Four 1-column keypads cannot mount to wallboxes.

* Use wallbox with 4 available mounting screw holes for maximum flexibility.

HomeWorks QS Wired Palladiom Keypad

QS Link Wiring

- Use SELV/PELV/NEC® Class 2 wiring to connect keypads to the QS link.
- Connect two 22 AWG (0.5 mm²) shielded, twisted pairs of wires to terminals 3 and 4 of the keypad control link connector. Shielding (drain) of the twisted-pair wires must be connected together as shown, but do not connect the shielding to earth/ground or to the keypad and do not allow the shielding to contact the grounded wallbox.
- The total length of wire on a QS wired link is not to exceed 2000 ft (610 m).

Note: Use appropriate wire connecting devices as specified by local codes.

- Each base unit model number counts as 1 device on the QS link.
- Each button column of a QS wired Palladiom Keypad consumes 1 power draw unit (PDU) on the QS link. For complete information, see “Power Draw Units on the QS Link” (Lutron P/N 369405).

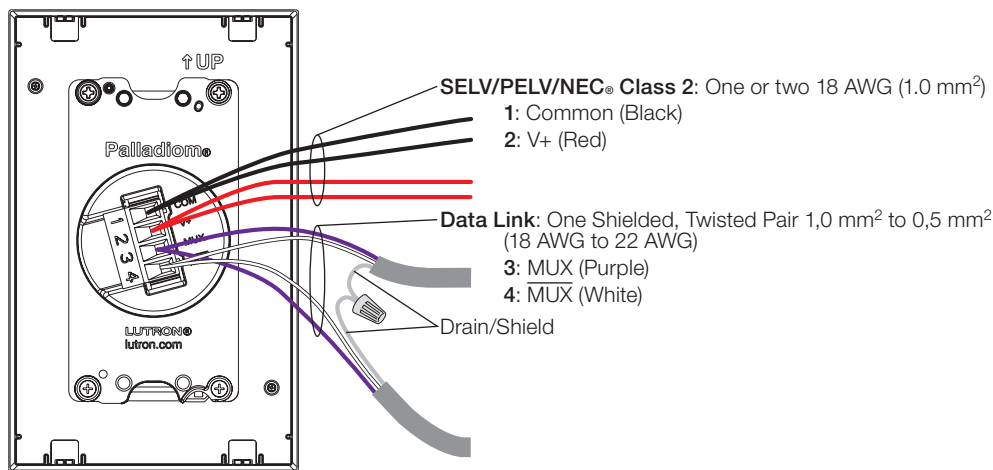

HomeWorks QS Wired Palladiom Keypad

Colors and Finishes

Architectural Matte Finishes

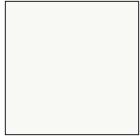

White
WH



Ivory
IV

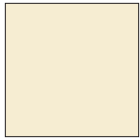

Almond
AL



Light Almond
LA

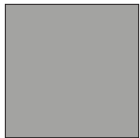

Gray
GR

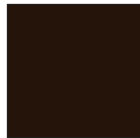

Brown
BR

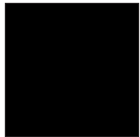

Black
BL



Taupe
TP

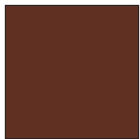

Sienna
SI

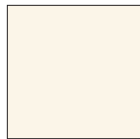

Beige
BE

Architectural Metal Finishes



Satin Brass
SB



Satin Nickel
SN



Satin Chrome
SC



Clear White Glass
CWH



Bright Brass
BB



Bright Nickel
BN



Bright Chrome
BC



Clear Black Glass
CBL



Polished Graphite
PG



Antique Brass*
QB

Glass Finish

- Due to printing limitations, colors and finishes shown cannot be guaranteed to perfectly match actual product colors.
- Color chip keychains are available for more precise color matching:
 - Architectural Matte Finishes: AM-CK-1
 - Architectural Metal Finishes: AMTL-CK-1

* Antique Brass is a handcrafted finish that is created using a manual relief process. This artisanal process can result in variations in luster, hue and appearance.

Lutron, GRAFIK T, Maestro, myRoom, Palladiom, and Quantum are trademarks or registered trademarks of Lutron Electronics Co., Inc. in the US and/or other countries.

NEC is a registered trademark of National Fire Protection Association, Quincy, Massachusetts.