



ABB i-bus[®] KNX Valve Drive Actuator VAA/S x.230.2.1 Product Manual

Contents

Page

1	General	3
1.1	Using the product manual.....	3
1.1.1	Structure of the product manual	4
1.1.2	Note	4
1.2	Product and functional overview.....	5
2	Device Technology	7
2.1	Technical data	7
2.2	Connection schematics.....	9
2.3	Dimension drawing	10
2.4	Assembly and installation	11
2.5	Manual operation.....	13
2.5.1	Display elements	14
2.5.2	Operating controls	15
3	Commissioning.....	17
3.1	Overview.....	17
3.1.1	Conversion	18
3.1.1.1	Procedure.....	19
3.1.2	Copying and exchanging parameter settings.....	20
3.1.3	Procedure.....	21
3.1.4	Copy/exchange channel dialog.....	22
3.2	Parameters	23
3.2.1	Parameter window <i>General</i>	24
3.2.2	Parameter window <i>Manual operation</i>	26
3.2.3	Parameter window A: <i>General</i>	28
3.2.4	Parameter window A: <i>Functions</i>	33
3.2.5	Parameter window A: <i>Characteristic curve correction</i>	37
3.3	Communication objects	40
3.3.1	Brief overview of the communication objects.....	40
3.3.2	Communication objects <i>General</i>	41
3.3.3	Communication objects <i>Output A</i>	43
4	Planning and Application	47
4.1	Behaviour during a malfunction	47
4.2	Bus voltage recovery	49
4.3	ETS reset.....	49
4.4	Download (DL).....	49
4.5	Bus voltage failure	50
4.6	Reaction at bus voltage recovery, download and reset	50
4.7	Priorities.....	50
A	Appendix	51
A.1	Scope of delivery	51
A.2	Code table <i>Status byte</i>	52
A.3	Ordering Information.....	53
A.4	Accessories	53
A.5	Notes	54

1 General

Modern building installation enables a high degree of functionality and simultaneously complies with increased security requirements. Due to the structured installation of the electrical components, it is possible to carry out rapid planning, installation and commissioning as well as achieve cost benefits during operation. With individual room control, potential savings of up to 25 % of the energy consumption can be achieved.

The technical systems for control of the room temperature and air quality consume the largest share of energy in a building. Accordingly, the largest savings can be made here. Mistaken or incorrect operation can lead to expensive waste of energy. High levels of energy consumption are greatly reduced or avoided by optimisation of a building with regard to the architecture, construction and installation engineering.

On a room level, the KNX intelligent installation systems support the user in optimisation of the energy consumption and provide information to the installation engineering or the building control engineering for optimisation of the setting parameters. By detecting the actual temperature value and specifying a respective temperature setpoint with a control algorithm, the thermostat sends a control value to the actuator, e.g. the Valve Drive Actuator VAA/S x.230.2.1. This controls an Electrothermal Valve Drive, e.g. TSA/K. This on the other hand opens or closes a valve of a heating or cooling unit, e.g. underfloor heating. This then changes the room temperature. An additional presence detector used for control of the room lighting can simultaneously switch the room thermostat to absent mode as soon as the room is unoccupied for an extended period. Heating or cooling energy can be conserved in this way.

Practical experience has shown that the reduction of the room temperature by 1 °C can reduce the consumption of heating energy by 6 %. If the room temperature is reduced by 3 °C during absence, 18 % of the heating energy can be saved in a non-occupied room.

1.1 Using the product manual

This manual provides you with detailed technical information relating to the function, installation and programming of the ABB i-bus[®] KNX VAA/S x.230.2.1. The application of the device is explained using examples.

This manual is divided into the following sections:

- Chapter 1 General
- Chapter 2 Device technology
- Chapter 3 Commissioning
- Chapter 4 Planning and application
- Chapter A Appendix

1.1.1 Structure of the product manual

All parameters are initially described in chapter 3. Directly following the parameter descriptions you can find descriptions for the communication objects.

Note

A Valve Drive Actuator features 6 or 12 outputs. However, as the functions and communication objects for all outputs are identical, only the functions of output A will be described.

1.1.2 Note

Notes and safety instructions are represented as follows in this manual:

Note

Tips for usage and operation.

Examples

Application examples, installation examples, programming examples.

Important

These safety instructions are used as soon as there is danger of a malfunction without risk of damage or injury.

Caution

These safety instructions are used as soon as there is danger of a malfunction without risk of damage or injury.



Danger

These safety instructions are used if there is a danger for life and limb with inappropriate use.



Danger

These safety instructions are used if there is a danger to life with inappropriate use.

1.2 Product and functional overview

The ABB i-bus[®] Valve Drive Actuators are modular installation devices in Pro *M* Design or installation in the distribution board.

The devices are used for control of valves via Electrothermal Valve Drives e.g. TSA/K, for room temperature control.

	VAA/S 6.230.2.1	VAA/S 12.230.2.1
Hardware		
Number of outputs	6	12
Nominal voltage	24...230 V AC	24...230 V AC
Rated current (per output)	160 mA	160 mA
Short-circuit and overload monitoring	■	■
Type of installation	MDRC	MDRC
Mounting width in space units	4	8
Manual operation	■	■

■ = property applies

ABB i-bus[®] KNX Device Technology

2 Device Technology



VAA/S 6.230.2.1

The Valve Drive Actuators VAA/S are modular installation devices in Pro M Design for installation in the distribution board on 35 mm mounting rails. The devices feature six or twelve semiconductor outputs for control of Thermolectric Valve Drives in heating and cooling systems. The outputs can be operated at 24...230 V AC. The outputs are short-circuit and overload protected.

The outputs can be directly controlled using the manual buttons. The LEDs on the front of the device signal the status of the outputs.

The connection to the ABB i-bus[®] KNX is implemented via a bus connection terminal.

The devices do not require an additional auxiliary power supply.

2.1 Technical data









Supply	Bus voltage	21...32 V DC
	Current consumption, bus	< 12 mA
	Leakage loss, bus	maximum 250 mW
	Leakage loss of the device at max. load	maximum 2 W at VAA/S 6.230.2.1 maximum 4 W at VAA/S 12.230.2.1
Outputs	6 or 12 semiconductor outputs	for every 3 non-isolated outputs in the group. Short circuit and overload protected
	Rated voltage U_n	24...230 V AC, 50/60 Hz
	Rated current I_n per output	160 mA resistive load at T_{amb} up to 45 °C
	Inrush current per output	maximum 300 mA for 2 min at T_A up to 60 °C
	Caution: When valve drives (e.g. TSA/K) are connected in parallel, the technical data of the respective valve drive must be observed! The inrush current (300 mA) or rated current (160 mA) of the output may not be exceeded.	
Connections	KNX	via bus connection terminals
	Output terminals	via universal head screw terminals 0.2... 4 mm ² stranded, 2 x 0.2...2.5 mm ² , 0.2...6 mm ² single core, 2 x 0.2...4 mm ²
Operating and display elements	Button/LED  	for assignment of the physical address
	Button  and LED 	for toggling between manual operation/operation via ABB i-bus [®] and displays
	One button  and LED  per output	for control (ON/OFF) of the output and display of the status
	One button  and LED  for every 3 outputs	for reset and indication of a fault e.g. short circuit and overload
Enclosure	IP 20	to EN 60 529
Safety class	II	to EN 61 140
Isolation category	overvoltage category	III to DIN EN 60 664-1
	pollution degree	2 to EN 60 664-1

ABB i-bus[®] KNX Device Technology

KNX safety extra low voltage	SELV 30 V DC	
Temperature range	Operation	-5 °C...+45 °C
	Storage	-25 °C...+55 °C
	Transport	-25 °C...+70 °C
Ambient conditions	Maximum air humidity	93 %, no condensation allowed
Design	Modular installation device (MDRC)	modular installation device, Pro M
	Dimensions	VAA/S 6.230.1: 90 x 72 x 64.5 mm (H x W x D) VAA/S 12.230.1: 90 x 144 x 64.5 mm(H x W x D)
	Mounting width in space units (modules at 18 mm)	4 or 8
	Mounting depth	64.5 mm
Installation	On 35 mm mounting rail	to EN 60 715
Mounting position	As required	
Weight (without batteries)	VAA/S 6.230.2.1:	approx. 0.16 kg
	VAA/S 12.230.2.1:	approx. 0.28 kg
Housing/colour	Plastic housing, grey	
Approvals	KNX to EN 50 090-1, -2	certification
CE mark	In accordance with the EMC guideline and low voltage guideline	

Device type	Application program	Maximum number of communication objects	Maximum number of group addresses	Maximum number of associations
VAA/S 6.230.2.1	Valve Drive 6f 230V/...*	59	255	255
VAA/S 12.230.2.1	Valve Drive 12f 230V/...*	113	255	255

* ... = current version number of the application program. **Please observe the software information on our homepage for this purpose.**

Note

The ETS and the current version of the device application program are required for programming. The current version of the application program is available for download on the internet at www.abb.com/knx. After import it is available in the ETS under *ABB/Heating, Ventilation, Air conditioning/Valve Drive Actuator*.

The device does not support the closing function of a KNX device in the ETS. If you inhibit access to all devices of the project with a *BCU code*, it has no effect on this device. Reading out data and programming is still possible.

2.2

Connection schematics

VAA/S 6.230.2.1

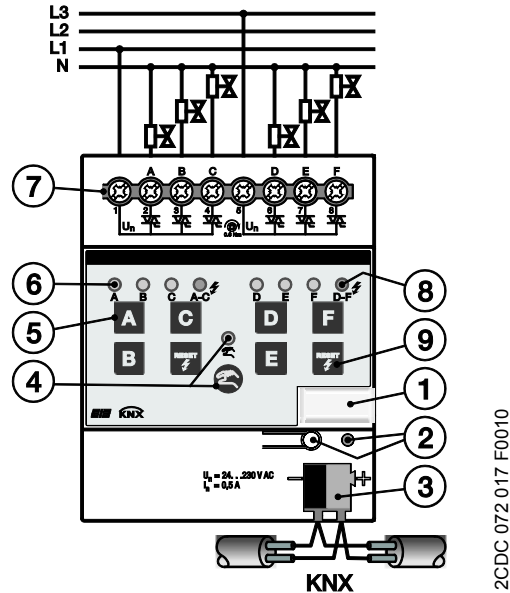

2CDC 072 017 F0010

VAA/S 12.230.2.1

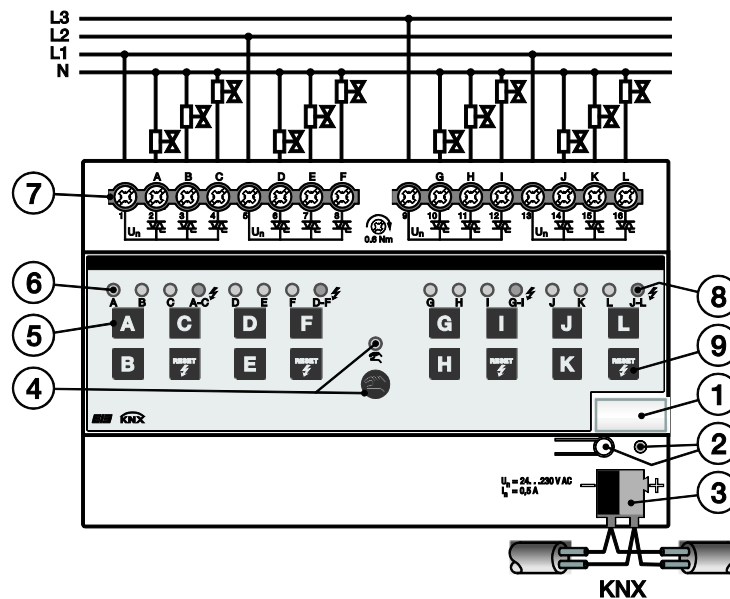

2CDC 072 016 F0010

- 1 Label carrier
- 2 Button/LED *Programming* (red)
- 3 Bus connection terminal
- 4 Button/LED *Manual Operation* (yellow)
- 5 Button ON/OFF **A...F** or **A...L** per output
- 6 LED ON/OFF (yellow) per output
- 7 Connection terminals for outputs A...F or A...L and power supply U_n
- 8 LED *Overload/Short Circuit* (red)
- 9 Button *Reset Overload/Short Circuit*

2.3 Dimension drawing

VAA/S 6.230.2.1

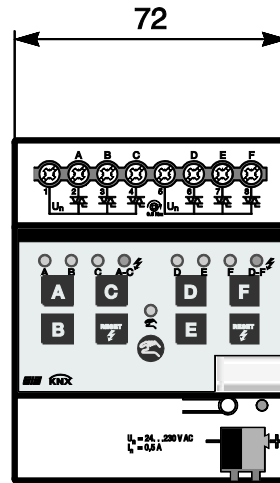
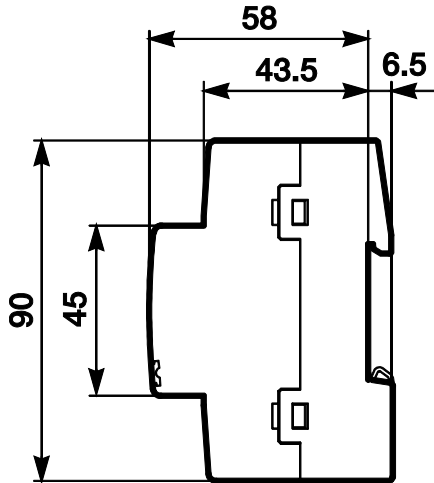

VAA/S 12.230.2.1

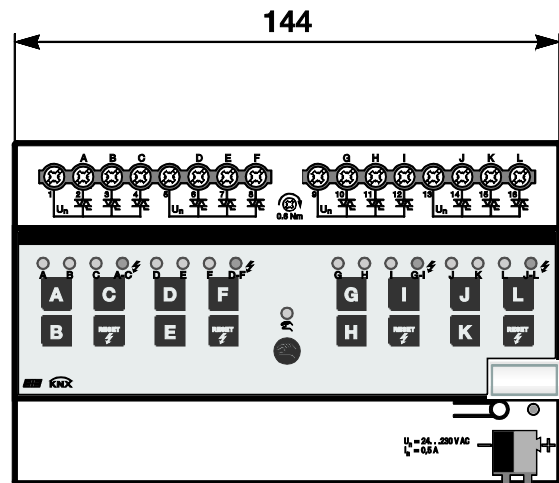
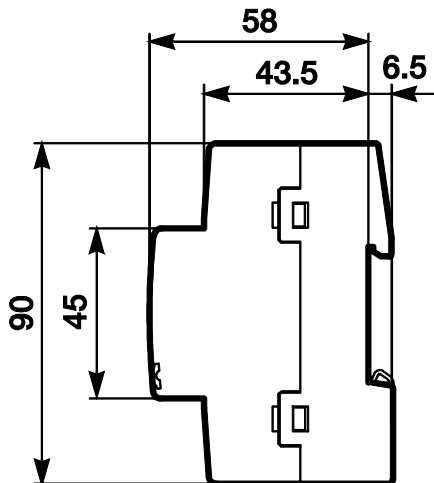

2.4 Assembly and installation

The ABB i-bus[®] KNX Valve Drive Actuator VAA/S x.230.2.1 is a modular installation device for quick installation in the distribution board on 35 mm mounting rails to EN 60 715.

The mounting position can be selected as required.

The electrical connection is implemented using screw terminals. The connection to the bus is implemented using the supplied bus connection terminal. The terminal assignment is located on the housing.

The device is ready for operation after connection to the bus voltage. If bus voltage is not yet available at the time of commissioning, the device can be supplied with power for operation of the manual buttons using the Power Supply NTI/Z.

Accessibility to the device for the purpose of operation, testing, visual inspection, maintenance and repair must be provided compliant to VDE 0100-520.

Commissioning requirements

In order to commission the device, a PC with ETS and a KNX interface, e.g. USB or IP, are required. The device is ready for operation after connection to the bus voltage.

The installation and commissioning may only be carried out by qualified electrical specialists. The appropriate norms, guidelines, regulations and specifications for your country should be observed when planning and setting up electrical installations and security systems for intrusion and fire detection.

Protect the device from damp, dirt and damage during transport, storage and operation.

Only operate the device within the specified technical data limits!

The device should only be operated in an enclosed housing (distribution board)!

The voltage supply to the device must be switched off, before mounting work is performed.



Danger

In order to avoid dangerous touch voltages, which originate through feedback from differing phase conductors, all-pole disconnection must be observed when extending or modifying the electrical connections.

Manual operation

The device incorporates manual operating features. Special device functions can be undertaken using the operating keys on the foil keypad.

The foil keypad may not be operated with pointed or sharp-edged objects, e.g. screwdrivers or pens. This may damage the keypad.

ABB i-bus[®] KNX Device Technology



Supplied state

The device is supplied with the physical address 15.15.255. The application program is preloaded. It is therefore only necessary to load group addresses and parameters during commissioning.

However, the complete application program can be reloaded if required. A longer downtime may result if the application program is changed or after a discharge.

Assignment of the physical address

The assignment and programming of the physical address is carried out in the ETS.

The device features a  button for assignment of the physical device address. The red  LED lights up, after the button has been pushed. It switches off as soon as the ETS has assigned the physical address or the  button is pressed again.

Download response

Depending on the PC, which is used, the progress bar for the download may take up to one and a half minutes, before it appears, due to the complexity of the device.

Cleaning

If devices become dirty, they can be cleaned using a dry cloth or a cloth dampened with a soapy solution. Corrosive agents or solutions should never be used.

Maintenance

The device is maintenance-free. No repairs should be carried out by unauthorised personnel if damage occurs, e.g. during transport and/or storage.

2.5 Manual operation

General

The outputs can be directly controlled using the buttons in manual operation.

Accordingly, the wiring of the loads connected to the outputs can be verified during commissioning. You can, for example, ensure that the connected valve drives open or close the valves correctly. If bus voltage is not yet available at the time of commissioning, the device can be supplied with power for manual operation using the Power Supply NTI/Z.



Function of manual operation

Manual operation facilitates on-location operation of the device. As standard the button  *Manual operation* is enabled and can be switched on and off using it.

Switch on of manual operation:

Press button  until the yellow LED  lights continuously.

Switch off of manual operation:

Press button  until the yellow LED  switches off.

The yellow LED  flashes during the switchover process.

After connection to the KNX, an ETS download or ETS reset, the device is in *KNX operation*. The LED  is off. All LEDs indicate the actual input state.

Note

If the *Manual operation* is generally disabled or disabled via communication object *Disable/enable man. operation*, the LED  flashes during a button push.

A switchover from KNX operation to the Manual operation mode does not occur.

Important

If manual mode is activated, it has a higher priority than other functions, e.g. safety. As soon as the output state is modified in manual mode via button *Output*, active functions, such as blocking, forced operation and valve purge are interrupted and values of the characteristic curve are not considered. Manual operation is inactive after bus voltage recovery, download or ETS reset.

Supplied state

Manual operation is enabled by default in the supplied state. The device is in KNX operation after connection to the bus. The yellow LED  is off. All LEDs for the outputs indicate the actual state. The buttons for the outputs are non-functional.

Telegram processing with active manual operation

Incoming telegrams will continue to be received and saved during active manual operation. After manual operation is deactivated, the device will update.



If a telegram with the value 1 is received via communication object *Enable/block manual operation*, active manual operation is deactivated and then blocked. Manual operation can no longer be activated by the manual buttons.

2.5.1 Display elements

Indicator LEDs are located on the front of the device.

All LEDs *Output X* indicate the actual state. In *KNX operation* the LED  is off.

The response of the display elements is described in the following table:

LED	Function/operation
	<p><i>On</i>: Manual operation</p> <p><i>Flashing</i>: Switchover process</p> <p><i>Off</i>: KNX operation</p>
 Output A...X	<p><i>On</i>: Output active, control value > 0, normal operation</p> <p><i>Flashes slowly (1 Hz)</i>: Safety function (blocking or forced operation) active</p> <p><i>Flashes quickly (5 Hz)</i>: Output blocked (short-circuit or overload on the output group)</p> <p><i>Off</i>: Output inactive</p>
 Fault	<p>Every three outputs form an output group. Each output group features an LED fault.</p> <p><i>On</i>: Overload of at least one output of an output group</p> <p>Slow flash (1 Hz): Short-circuit testing of the output group</p> <p>Fast flash (5 Hz): At least one output of an output group is blocked</p> <p><i>Off</i>: Normal operation, no fault</p>

2.5.2 Operating controls

Buttons for manual operation are located on the front of the device.

If manual operation is activated, the current control value of the respective output is retained and the yellow LEDs on the outputs indicate the current status (ON/OFF). A target position, which may not have yet been achieved, is approached. The outputs can now only be operated via the manual buttons for the outputs. The first button push switches on the output if the control value = 0. If the control value > 0, the output is switched off. Every subsequent button push toggles the output.

The behaviour of the operating elements dependent on the operating states, *KNX operation* and *Manual operation* is described in the following table:











Button	KNX operation	Manual operation
 Manual operation	<p><i>Long button operation (about 3 sec.):</i> Switch to <i>Manual operation</i>, provided that <i>Manual operation</i> is not blocked by a parameter setting.</p> <p><i>Short button push:</i> LED  <i>Manual operation</i> flashes and switches off again. The device is once again in <i>Manual operation</i></p>	<p><i>Long button operation (about 3 sec.):</i> Changeover to the <i>KNX operation</i>. The inputs are queried again, and the input states are updated accordingly.</p> <p>The reset of <i>Manual operation</i> to <i>KNX operation</i> can be undertaken in a programmable time, depending on the parameterization.</p>
 Output A...X	No reaction	<p>By pressing button  output A is switched on or off. A connected valve drive opens/closes the valve.</p> <p>The display  indicates the current switching state of the output.</p>
 Reset	<p>For resetting a fault, e.g. short-circuit or overload of an output group. The button  must be pushed until the red LED  switches off, for this purpose.</p> <p>The button function is inactive during an ongoing short-circuit test.</p>	<p>For resetting a fault, e.g. short-circuit or overload of an output group. The button  must be pushed until the red LED  switches off, for this purpose.</p> <p>The button function is inactive during an ongoing short-circuit test.</p>

ABB i-bus[®] KNX Commissioning

3 Commissioning

The ABB i-bus[®] KNX Valve Drive Actuators VAA/S x.230.2.1 are actuators for control of electrothermal valve drives for room temperature control. The outputs each feature the same range of functions, whereby each output can be parameterized individually. A short overview of all functions of the Valve Drive Actuators can be found in the next chapter.

3.1 Overview

The following table provides an overview of the functions with the Valve Drive Actuators VAA/S x.230.2.1 and their application program:

	VAA/S 6.230.2.1	VAA/S 12.230.2.1
General		
Cyclic monitoring telegram (In operation)	■	■
Limit number of sent telegrams	■	■
Sending and switching delay after bus voltage recovery	■	■
Limit rate of telegrams	■	■
Reset error messages for all outputs	■	■
Request status values via object	■	■
Manual operation		
Disable/enable via object	■	■
Automatic reset in KNX operation after a time	■	■
Manual operating status	■	■
Output X General		
Error messages (short-circuit/overload)	■	■
Reaction on bus voltage recovery	■	■
Type of valve drive	■	■
Control		
- Control value 1 bit (on/off)	■	■
- Control value 1 bit (PWM or on/off)		
- Status control 1 bit/1 byte		
Cyclic monitoring of control value	■	■
Output X Functions		
Block	■	■
Forced operation	■	■
Valve purge		
- Activate via object	■	■
- Adjustable purge duration		
- Cyclic purge		
- Status valve purge		
Characteristic curve correction	■	■
Status byte	■	■

■ = property applies

ABB i-bus[®] KNX Commissioning

3.1.1 Conversion

For ABB i-bus[®] KNX devices from ETS3 or higher, it is possible to assume the parameter settings and group addresses from earlier application program versions.

Furthermore, conversion can be applied to transfer the existing parameterization of a device to another device.

Note
When the term “channels” is used in the ETS, inputs and/or outputs are meant. In order to ensure that the ETS language generally applies for as many ABB i-bus [®] devices as possible, the word channels is used here.

ABB i-bus[®] KNX Commissioning

3.1.1.1

Procedure

- Insert the required device into the project.
- Import the current application program into the ETS.
- Perform parameterization and program the device.
- After you have parameterized a device, you can transfer the settings to a second device.
- Right click on the product and select *Plug-in* > *Convert* in the context menu for this purpose.

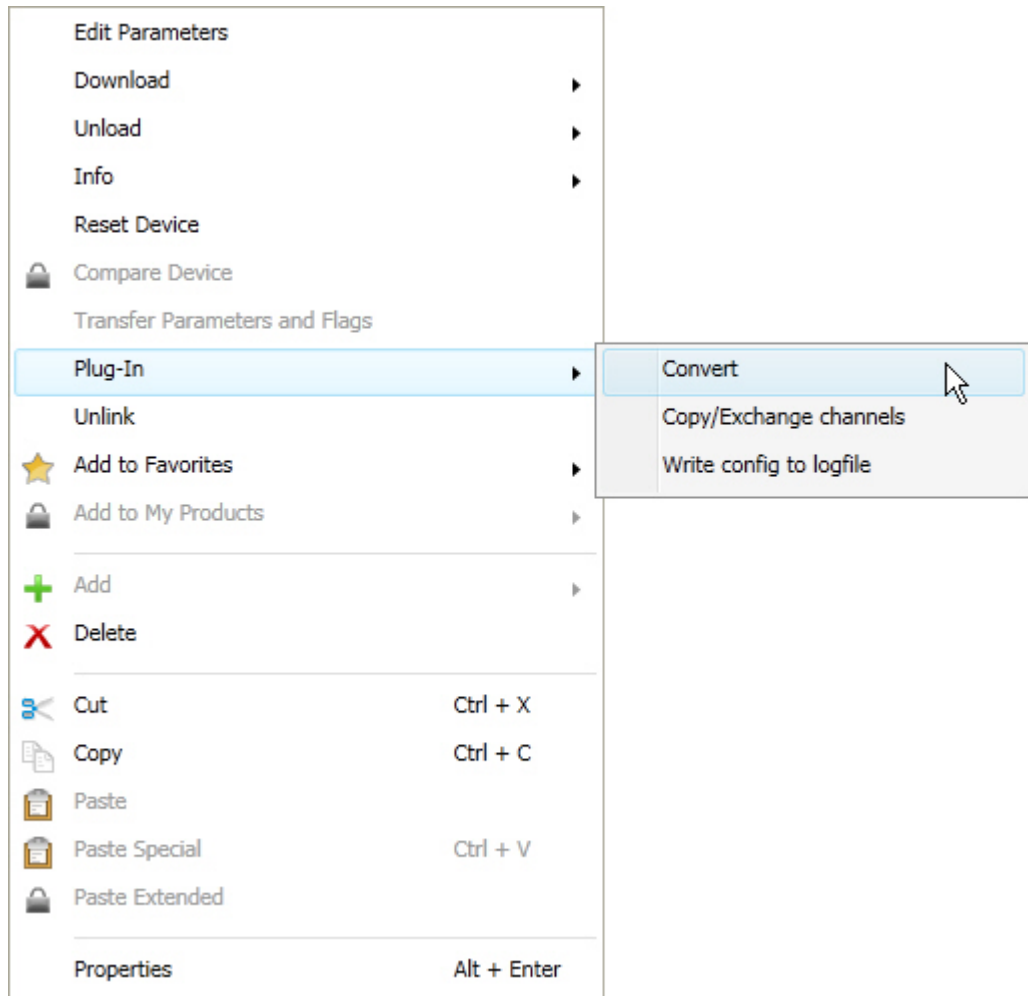

- Thereafter undertake the required settings in the *Convert* dialog.
- Finally, exchange the physical address and delete the old device.

Should you wish to only copy individual channels within a device, use the function [Copy and exchange](#), page 21.

ABB i-bus[®] KNX Commissioning

3.1.2 Copying and exchanging parameter settings

Parameterization of devices can take a lot of time depending on the complexity of the application and the number of device inputs/outputs. To keep the commissioning work to the shortest time possible, using the function *Copy/exchange channels*, parameter settings of an input/output can be copied or exchanged with freely selectable inputs/outputs. Optionally, the group addresses can be retained, copied or deleted in the target input/output.

Note
When the term “channels” is used in the ETS, inputs and/or outputs are meant. In order to ensure that the ETS language generally applies for as many ABB i-bus [®] devices as possible, the word channels is used here.

The copy function for inputs/outputs is particularly useful with devices having the same parameter settings for several outputs, inputs or groups. For example, lighting in a room is frequently controlled in an identical manner. In this case, the parameter settings from input/output X can be copied to all other inputs/outputs or to a special input/output of the device. Thus the parameters for this input/output must not be set separately, which significantly shortens the commissioning time.

The exchange of parameter settings is useful, e.g. should the inputs/outputs be swapped when wiring the terminals. The parameter settings of the incorrectly wired inputs/outputs can be simply exchanged saving the requirement for time-consuming rewiring.

ABB i-bus[®] KNX Commissioning

3.1.3

Procedure

- Insert the required device into the project.
- Import the current application program into the ETS.
- Click with the right mouse button on the product, whose outputs you wish to copy or exchange, and select the context menu *Plug-in > Copy/exchange channels*.

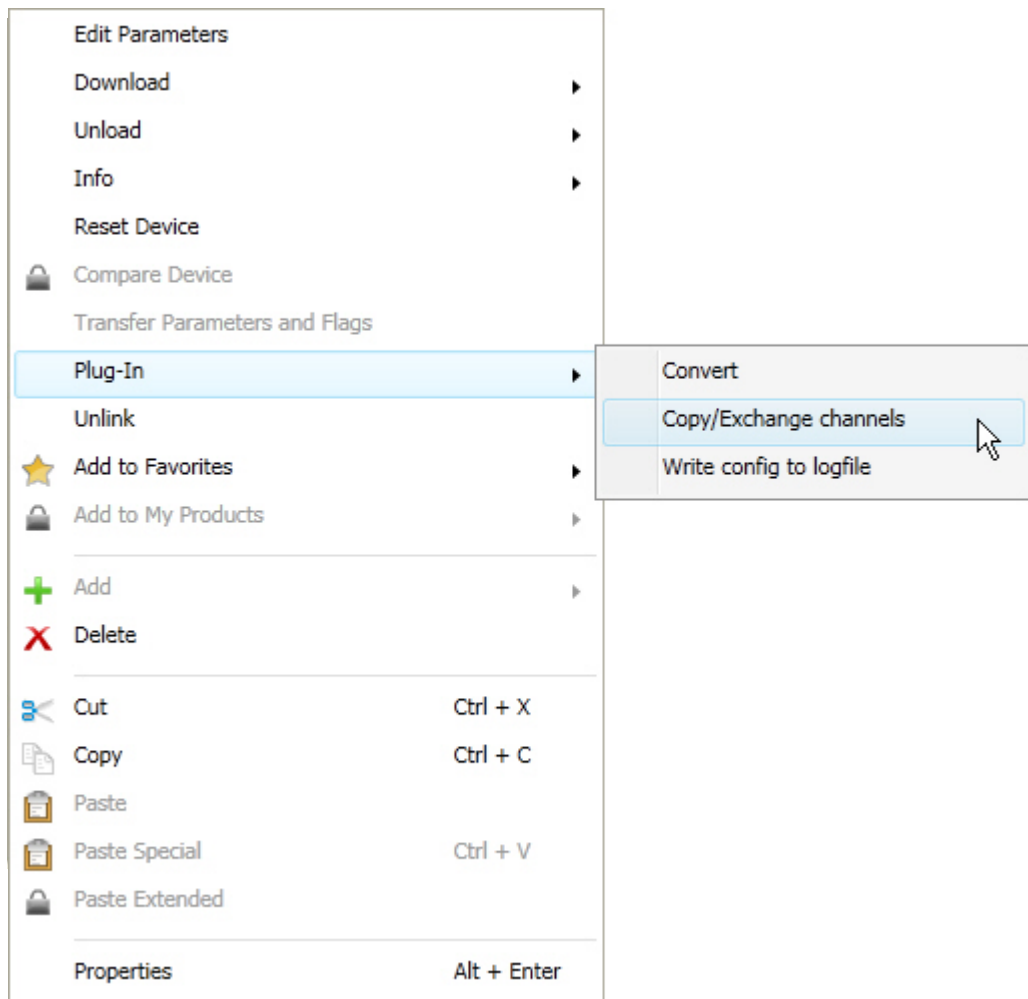

Thereafter undertake the required settings in the *Copy/exchange channel* dialog.

3.1.4 Copy/exchange channel dialog

The dialog box is titled "Copy/exchange channel dialog". It is divided into several sections. At the top, there are two list boxes: "Source channel" and "Destination channels". Both list boxes contain the following items: "A: General", "B: General", "C: General", and "D: General". Below the "Destination channels" list box are two buttons: "All" and "None". Below these list boxes are three radio button options:
• Keep group addresses in the destination channel unchanged (if possible)
• Copy group addresses
• Delete group addresses in the destination channel
A "Copy" button is located to the right of the second and third radio button options. Below these are three more radio button options:
• Exchange without group addresses
• Exchange with group addresses
• Delete group addresses
An "Exchange" button is located to the right of the second radio button option. At the bottom of the dialog are "OK" and "Cancel" buttons.

At the top left, you will see the source channel selection window for marking the source channel. Beside is located the selection window for the target channel or channels for marking the target channel or channels.

Source channel

With the selection of the source channel, you define which parameter settings should be copied or exchanged. Only one source channel can be selected at a time.

Target channels

With the selection of the target channels, you define which channel/channels are to assume the parameter settings of the source channel.

- For the function *Exchange* only one target output can be selected at a time.
- For the function *Copy*, different target channels can be selected simultaneously. For this purpose, press the Ctrl key and mark the required channels with the mouse cursor, e.g. channels B and C.

	With this button, you select all available target channels, e.g. A...C.
	Reset the selection of the target channel with this button.

ABB i-bus[®] KNX Commissioning

Copy

The following options can be selected before copying the parameter settings:

- Leave the group addresses unchanged (if possible) in the target channel
- Copy group addresses
- Delete group addresses in the target channel

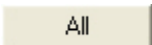
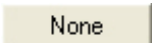
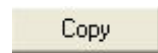

With this button, copy the settings of the source channel into the target channel or channels.

Exchange

The following options can be selected before exchanging the parameter settings:

- Retain group addresses
- Exchange of group addresses
- Deletion of group addresses



With this button, exchange the settings of the source channel with the target channel.



Confirm your selection with this button, and the window closes.

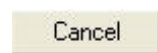

Using this button, the window closes without accepting the changes.

3.2

Parameters

Programming of the Valve Drive Actuator is implemented with the Engineering Tool Software (ETS).

The application program is available in the ETS3 at *ABB/Heating, Ventilation, Air conditioning/Valve Drive Actuator*.

The following chapter describes the parameters of the device using the parameter window. The parameter window features a dynamic structure, so that further parameters may be enabled depending on the parameterization and the function.

The default values of the parameters are underlined, e.g.

Options: yes
 no

3.2.1 Parameter window *General*

In this parameter, the parameters are defined that determine the overall behaviour of the device.

Send communication object “In operation”

Options: no
 send value 0 cyclically
 send value 1 cyclically

The communication object *In operation* (no. 0) indicates the presence of the device on the bus. This cyclic telegram can be monitored by an external device. If a telegram is not received, the device may be defective or the bus cable to the transmitting device may be interrupted.

- *no*: The communication object *In operation* is not enabled.
- *send value 0/1 cyclically*: The communication object *In operation* (no. 0) is sent cyclically on the KNX. The following parameter appears:

Sending cycle time in s [1...65,535]

Options: 1..60...65,535

Here the time interval is set, at which the communication object *In operation* (no. 0) cyclically sends a telegram.

Note

After bus voltage recovery, the communication object sends its value after the set sending and switching delay.

ABB i-bus[®] KNX Commissioning

Sending and switching delay after bus voltage recovery in s (2...255)

Options: 2...255

Telegrams are only received during the send and switching delay. The telegrams are not processed, however, and the outputs remain unchanged. No telegrams are sent on the bus.

After the sending and switching delay, telegrams are sent, and the state of the outputs is set to correspond to the parameterization or the communication object values.

If communication objects are read during the sending and switching delay, e.g. by a visualisation system, these read requests are stored and a response is sent, after the send and switching delay has been completed.

An initialisation time of about two seconds is included in the delay time. The initialisation time is the time that the processor requires to be functional.

How does the device behave with bus voltage recovery?

After bus voltage recovery, the device always waits for the send delay time to elapse before sending telegrams on the bus.

Limit number of telegrams

Options: no
yes

The load on the KNX generated by the device can be limited with the limitation on the number of telegrams sent. This limit relates to all telegrams sent by the device.

- **yes:** The following parameters appear:

Max. number of sent telegrams [1...255]

Options: 1...20...255

in period

Options: 50 ms / 100 ms ...1 s...30 s / 1 min

This parameter defines the number of telegrams sent by the device within a period. The telegrams are sent as quickly as possible at the start of a period.

Enable communication object "Request status values" 1 bit

Options: no
yes

Via this communication object, all status messages can be requested provided that they have been parameterized with the option *after a change or request*.

- **yes:** The 1 bit communication object *Request status values* is enabled. The following parameter appears:

Request with object value

Options: 0
1
0 or 1

- **0:** Sending status messages is requested with the value 0.
- **1:** Sending status messages is requested with the value 1.
- **0 or 1:** Sending status messages is requested with the values 0 or 1.

3.2.2 Parameter window *Manual operation*

In this parameter window all the settings for manual operation can be made. For a detailed description of manual operation see [Manual operation](#), page 13.

General	Manual operation	enabled
Manual operation	Reset manual operation to KNX operation:	after 1 Minute
A: General	Enable communication object "Status man. operation" 1 bit	no
A: Functions		
B: General		
B: Functions		

Manual operation

Options: enabled
 disabled
 disable/enable via communication object

This parameter defines if the switch over between the operating states *Manual operation* and *KNX operation* is enabled or disabled via the button ● on the device or via a communication object.

- *enabled*: The operating states *Manual operation* and *KNX operation* can be toggled via button ●.
- *disabled*: Manual operation is generally disabled.
- *disable/enable via communication object*: The communication object *Disable /enable man. operation* appears.

Telegram value: 0 = button ● enabled
 1 = button ● disabled

If manual operation has been selected with the option *enabled* or the option *disable/enable via communication object*, two further parameters appear:

Reset manual operation to KNX operation

Options: no
 after 1/3/10/30 minutes

This parameter determines how long manual operation remains activated or after how long switch over to KNX operation occurs.

- *no*: Manual operation remains activated until it is deactivated again using the manual operation button ● or using the communication object.
- *after X minutes*: Manual operation remains activated after the last operation of the button until the parameterized time has timed out or it is deactivated again using the manual button ●.

ABB i-bus[®] KNX Commissioning

Enable communication object "Status man. operation" 1 bit

Options: no
 yes

- *yes*: The 1 bit communication object *Status manual operation* (no. 2) is enabled. An additional parameter appears:

Send object value

Options: no, update only
 after a change
 after request
 after a change or request

- *no, update only*: The status is updated but not sent.
- *after a change*: The status is sent after a change.
- *after request*: The status is sent after a request.
- *after a change or request*: The status is sent after a change or a request.

3.2.3

Parameter window A: General

General	Type of valve drive	de-energised closed
Manual operation	Reaction after bus voltage recovery	unchanged
A: General	Control value is received as	1 bit
A: Functions	Cycle time of PWM in s [10..6,000]	180
B: General	Opening time of valve drive in s [10..6,000]	180
B: Functions	Closing time of valve drive in s [10..6,000]	180
C: General	Set cycle time PWM, open./closing time for contr. value in % on bus voltage recovery, controller fault, forced operation and characteristic curve.	<--- NOTE
C: Functions	Monitoring control values e.g. thermostat	no
D: General		
D: Functions		
E: General		
E: Functions		
F: General		
F: Functions		
G: General		
G: Functions		
H: General		
H: Functions		
I: General		
I: Functions		
J: General		

Type of valve drive

Options: de-energised opened
 de-energised closed

This parameter defines the additional functions of the electrothermal valve drive output.

Note
<p>De-energised closed valve drives (N.C. = normally closed) If no current flows in the valve drive, the valve is closed. If current flows in the valve drive, the valve opens.</p> <p>De-energised opened valve drives (N.O. = normally opened) If no current flows in the valve drive, the valve opens. If current flows in the valve drive, the valve then closes.</p>

Reaction after bus voltage recovery

Options: unchanged
 select

This parameter determines the response of the output at bus voltage recovery.

- *unchanged*: The last control value received before bus voltage failure is set. This also applies if a function with a higher priority, e.g. Block, was active before bus voltage failure. If a value for control in % at bus voltage failure is predefined, this will be reactivated at bus voltage recovery.
- *select*: The following parameter appears:

ABB i-bus[®] KNX Commissioning

Control value in % [0...100]

Options: 0...100

This parameter determines the control of the output after bus voltage recovery in %.

If a control value is received via a 1 bit value, on parameter [Cycle time of PWM in s \[10...6,000\]](#), page 30, a value must be entered. This value is used as the basis for calculation of the output control at bus voltage recovery in %

Note

Control value in %

The actual valve setting in % may diverge from the set value for control in % depending on the ambient conditions, e.g. room temperature, valve drive used, water pressure in the heating/cooling system, valve, etc.

The set value in the parameter *Control value in %* is based on the parameter *Cycle time of PWM*. The output is controlled accordingly depending on the setting.

Example parameter settings:

Control value in % [0...100]: 70 %

Cycle time of the PWM in s [10...6,000] 60 s

With these settings, the output switches ON for 42 s and OFF for 18 s ($60 \text{ s} \times 0.7 = 42 \text{ s}$).

Quick heat up/cool down

An additional time is determined that is dependent on the change in the control value and the closing and opening times of the valve drive. This additional time extends the switch on and off duration after a change in the control value. Accordingly, the new control value is achieved quickly.

Control value is received as

Options: 1 bit
1 byte

This parameter defines how the sent control value is received by the thermostat. Depending on the selection made, the communication object for the [Control value](#), page 43, (1 bit or 1 byte) is displayed.

- *1 bit*: The control value is sent by the thermostat as a PWM signal or a two-step signal (ON/OFF). The parameter for setting the PWM-cycle time and the communication object *Control value, switch 1 bit* appear.

*PWM = pulse width modulation.

Note

Pulse width modulation

With pulse width modulation, the valve is operated as with 2-point control exclusively in the positions *fully opened* and *fully closed*. In contrast to a 2-point control, the position is not controlled via limit values, but rather by calculated control values similar to continuous control.

The control value is fixed for a timed cycle and recalculated for the switch on duration of the output. The control value 20 % at a cycle time of 15 minutes, for example, will be recalculated for a switch on duration of three minutes.

The control value 50 % results in a switch on duration of 7.5 minutes.

Using pulse width modulation, a relatively exact control of the temperature is achieved without high levels of overshoot. Simple, attractively-priced thermoelectric valve drives can be used.

- **1 byte:** The control value is sent by the thermostat as a continuous positioning telegram (0...255). The communication object [Control value, continuous \(PWM\) 1 byte](#), page 43 and further parameters appear.

Note
1 byte control For 1 byte control, a value of 0...255 (corresponds to 0...100 %) is preset by the room thermostat. This process is also known as <i>continuous control</i> . At 0 %, the output switches off (the valve is closed); at 100 %, the output switches on (the valve is fully opened).

Convert control value to

Options: PWM (pulse width modulation)
OPEN/CLOSE-Signal

This parameter determines how the received control value (0...255) can be processed. The control value can be converted to a PWM signal or an ON/OFF signal.

- **PWM (pulse width modulation):** The continuous control value is converted to a PWM signal. The PWM cycle time must be defined in the parameter *Cycle time of PWM*.
- **OPEN/CLOSE-Signal:** The continuous control value is converted into an OPENING or CLOSING signal from a parameterizable value. The parameter for entering the threshold value appears.

OPEN at control value greater or equal in % [1...100]

Options: 1...100

This parameter determines the threshold value for the ON/OFF signal. The output switches ON continuously if the value parameterized here is greater than or equal to the received control value. If a control value that is less than the parameterized value is received, the output switches OFF.

Cycle time of PWM in s [10...6,000]

Options: 10...180...10,000

This parameter sets the cycle time for pulse width modulation.

If the control value is received via a 1 bit value, this parameter serves as the basis for calculation of the control of the output with

- bus voltage failure/recovery,
- forced operation,
- fault of the control value (control fault) and
- characteristic curve correction.

ABB i-bus[®] KNX Commissioning

Opening time of valve drive in s [10...6,000]

Options: 10...180...6,000

This parameter determines the time, which the connected valve drive requires for a complete motion (from closed = 0 % to fully opened = 100 %).

Closing time of valve drive in s [10...6,000]

Options: 10...180...6,000

This parameter determines the time, which the connected valve drive requires for a complete motion (from fully opened = 100 % to fully closed = 0 %).

Note

The closing and opening times should be taken from the technical data of the valve drive or should be determined during set-up and commissioning.

The ABB i-bus[®] Valve Drives of types TSA/K 230.1 and TSA/K 24.1 have closing and opening times of about three minutes.

The ABB i-bus[®] Valve Drives of types TSA/K 230.1 and TSA/K 24.1 (version de-energised closed / N.C.) in the default delivered state are opened by the First-Open function. Accordingly, heating operation is enabled during the building phase, even when the electrical wiring and engineering of the individual room control is not yet implemented.

When setting up at a later stage, the First-Open function is automatically unlocked after operating voltage has been applied (for longer than 6 minutes). The valve drive is ready to function.

Monitoring control values e.g. thermostat

Options: no
yes

This function is used for monitoring cyclic sending of the control value of the thermostat. The absence of a control value, e.g. due to malfunction of the thermostat, can cause a previously parameterized control value to be used to continue with heating and cooling operation on an emergency basis.

- yes: The communication object [Fault control value](#), page 43, is enabled. The following parameters appear:

Monitoring time in s [30...65,535]

Options: 30...120...65,535

This parameter sets the time used to monitor the telegrams on the input control values: Communication objects *Control value, switch 1 bit* or *Control value, continuous (PWM) 1 byte*.

If a setting variable is not received within the parameterized time, a malfunction or a defective thermostat is the cause.

The reaction of the output to a control value not received can be defined in the following parameters.

Send object value (Object "Fault control value" 1 bit)

Options: no, update only
 after a change
 after request
 after a change or request

- *no, update only*: The status is updated but not sent.
- *after a change*: The status is sent after a change.
- *after request*: The status is sent after a request.
- *after a change or request*: The status is sent after a change or a request.

Control value after controller fault in % [0...100]

Options: 0...30...100

The value for the control of the output in percent is determined here when the control value is not displayed.

If a control value is received via a 1 bit value, on parameter [Cycle time of PWM in s \[10...6.000\]](#), page 30, a value must be entered. This value is used as the basis for calculation of the output control at control fault in %.

3.2.4

Parameter window A: Functions

Functions, various functions for each output can be activated.

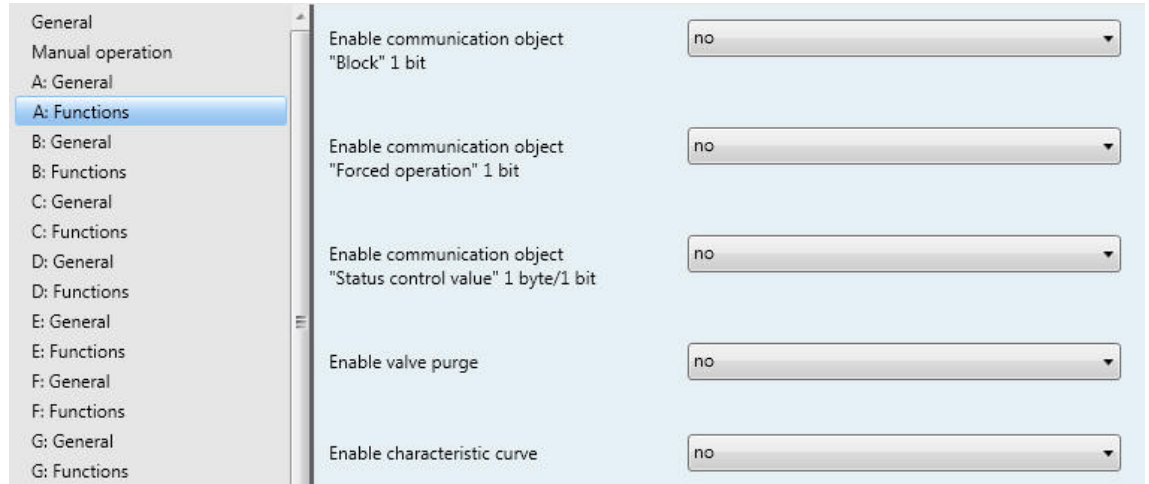

Enable communication object "Block" 1 bit

Options: no
yes

- yes: The 1 bit communication object [Block](#), page 44, is enabled. The following parameter appears:

Block on object value

Options: $\frac{1}{0}$

This parameter determines the value of the communication object used to block the output.

Enable communication object "Forced operation" 1 bit

Options: no
yes

- yes: The 1 bit communication object [Forced operation](#), page 44, is enabled. The operation of the output is blocked via the forced operation. The output assumes a defined state. The following parameters appear:

Forced operation on object value

Options: $\frac{1}{0}$

This parameter determines the value of the communication object used to forcibly operate the output.

ABB i-bus[®] KNX Commissioning

Control value on forced operation in % [0...100]

Options: 0...30...100

This parameter determines the control value that the output should assume at forced operation.

If a control value is received via a 1 bit value, a value must be entered on parameter [Cycle time of PWM in s \[10...6,000\]](#), page 30. This value is used as the basis for calculation of the output control at forced operation in %.

Enable communication object "Status control value" 1 byte/1 bit

Options: no
1 bit
1 byte

The control status of the output is sent via this communication object.

- *1 bit*: The communication object [Status control value](#), page 45, (1 bit) and the following parameter appears:

Send object value

Options: no, update only
after a change
after request
after a change or request

- *no, update only*: The status is updated but not sent.
- *after a change*: The status is sent after a change.
- *after request*: The status is sent after a request.
- *after a change or request*: The status is sent after a change or a request.

Object value at control value > 0

Options: $\frac{1}{0}$

If the communication object value is greater than 0, a telegram with the value 1 or 0 can be sent via this parameter.

- *1 byte*: The communication object [Status control value](#), page 45, (1 byte) and the following parameters are displayed:

ABB i-bus[®] KNX Commissioning

Enable valve purge

Options: no
 yes

- yes: The communication object [Trigger valve purge](#), page 44, appears.

Note

Functions with higher priority are executed and interrupt valve purging. If the interruption duration is longer than the period of valve purge, the valve purge will no longer be executed after, the higher priority has been rescinded.
The control for valve purging is always the control value 100 %. A correspondingly matched correction curve is taken into consideration.

With the option yes the following parameters appear:

Enable communication object "Status valve purge" 1 bit

Options: no
 yes

The status of the valve purge is visible via this communication object.

- yes: The 1 bit communication object [Status valve purge](#), page 45, and further parameters appear:

Send object value

Options: no, update only
 after a change
 after request
 after a change or request

- *no, update only*: The status is updated but not sent.
- *after a change*: The status is sent after a change.
- *after request*: The status is sent after a request.
- *after a change or request*: The status is sent after a change or a request.

Duration of valve purge in min. [1...255]

Options: 1...10...255

This parameter sets the length of time, for which the valve is to be purged. The valve is fully opened during a valve purge. When the time for duration of valve purge has elapsed, the last control value received is set.

Automatic valve purge

Options: no
 yes

- yes: The following parameters appear:

Purge cycle in weeks [1...12]

Options: 1...6...12

The internal automatic purge timer starts directly after a download. The time is reset each time it is downloaded.

The time is reset as soon as purging is completed. This can occur either through automatic purging or via the communication object *Trigger valve purge*.

Note

Purging can also be triggered via the bus using the communication object *Trigger valve purge*.

After bus voltage recovery and download, the automatic purging cycle is restarted. The time before bus voltage failure is not considered.

The purging cycle will automatically restart if *Purge cycle in weeks [1...12]* is changed after the download.

Reset purge cycle from control value in % [1...99]

Options: 1...99

This parameter determines when the purge cycle is to be reset after the set control value.

Note

The purging cycle time is restarted if automatic valve purge has been activated at start-up of the device.

The purging cycle time will be restarted at the end of the actual purging period. The parameterized period of valve purging is included here.

The entry of the opening time for the valve drive must be considered when entering the period for valve purge.

The purging cycle with an active automatic valve purge is reset and restarted if:

- A manual valve purge is triggered via the communication object *Trigger valve purge*.
- A parameterized value is received on the communication object *Control value (Reset purge cycle from control value in % [1...99])*.

Enable characteristic curve

Options: no
 yes

- yes: Parameter window *Characteristic Curve* appears.

3.2.5

Parameter window A: Characteristic curve correction

This parameter window is enabled if in [Parameter window A: Functions](#), page 33, the parameter *Enable characteristic curve* has been parameterized with the option *yes*. In this parameter window, an adaptation of the valve drive to the valve that is employed can be undertaken using the characteristic curve

Control value in % [0...100]	Valve position in % [0...100]
0	0
100	100

Enable value pair 3: no

correction. A characteristic correction optimizes the control behaviour of the system if required.

Important

A characteristic correction should only be undertaken in exceptional cases, and extensive knowledge in heating, air-conditioning and ventilation systems is a prerequisite.

The following must be considered with the characteristic curve correction:

- The value pairs can be entered in any sequence. They are sorted in ascending order of the control value in the device, and intermediate values are interpolated.
- If no value pair has been entered for the control value 0 %, the valve position of the first value pair applies for all control from 0 to the first value pair.
- If no value pair has been entered for the control value 100 %, the control values from the last value pair up to 100 % applies for the last value pair.
- The parameter [Cycle time of PWM in s \[10...6,000\]](#), page 30, serves as the basis for calculation of the control of the output for the characteristic curve correction, even if control value is processed via a 1 bit value.

Caution

Value pairs with the same control value can cause a non-defined characteristic curve. This fact must be considered during parameterization.

ABB i-bus[®] KNX Commissioning

Example:

Value pair 1 (VP1)

Control value in % [0...100] **10**
Valve position in % [0...100] **40**

Value pair 2 (VP2)

Control value in % [0...100] **80**
Valve position in % [0...100] **20**

Implemented characteristic curve correction:

Control value	Valve position
0...10%	40%
20%	37%
30%	34%
40%	31%
50%	29%
60%	26%
70%	23%
80...100%	20%

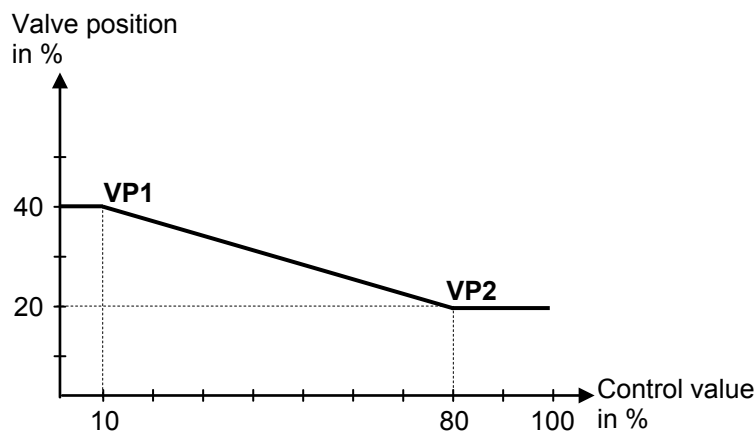

Value pair 1

Control value in % [0...100]

Valve position in % [0...100]

Options: 0...100

Value pair 2

Control value in % [0...100]

Valve position in % [0...100]

Options: 0...100

The possibility of activating other value pairs allows different curve characteristics to be realised.

A total of four value pairs can be set.

ABB i-bus[®] KNX Commissioning

Enable value pair 3

Options: no
 yes

- yes: Value pair 3 appears.

Value pair 3

Control value in % [0...100]

Valve position in % [0...100]

Options: 0...50...100

Enable value pair 4

Options: no
 yes

- yes: Value pair 4 appears.

Value pair 4

Control value in % [0...100]

Valve position in % [0...100]

Options: 0...50...100

3.3 Communication objects

3.3.1 Brief overview of the communication objects

CO* No.	Function	Name	Data Point Type (DPT)	Length	Flags				
					C	R	W	T	A
0	In operation	General	DPT 1.002	1 bit	x	x		x	
1	Request status values	General	DPT 1.017	1 bit	x		x	x	
2	Status manual Operation	General	DPT 1.003	1 bit	x	x		x	
3	Disable/enable man. operation	General	DPT 1.003	1 bit	x	x	x		
4	Reset overload/short circuit	General	DPT 1.015	1 bit	x		x	x	
5...9	Not assigned								
10	Control value, switch	Output A	DPT 1.001	1 bit	x		x		
	Control value, continuous (PWM)	Output A	DPT 5.001	1 byte	x		x		
11	Overload/short circuit	Output A	DPT 1.005	1 bit	x	x		x	
12	Not assigned								
13	Fault control value	Output A	DPT 1.005	1 bit	x	x		x	
14	Block	Output A	DPT 1.003	1 bit	x		x		
15	Forced operation	Output A	DPT 1.003	1 bit	x		x		
16	Trigger valve purge	Output A	DPT 1.003	1 bit	x		x		
17	Status valve purge	Output A	DPT 1.003	1 bit	x	x		x	
18	Status control value	Output A	DPT 5.001	1 byte	x	x		x	
	Status control value	Output A	DPT 1.002	1 bit	x	x		x	
19	Status byte	Output A	NON-DPT	1 byte	x	x		x	
20...29	Output B, the same CO as output A	B: see output A							
30...39	Output C, the same CO as output A	C: see output A							
40...49	Output D, the same CO as output A	D: see output A							
50...59	Output E, the same CO as output A	E: see output A							
60...69	Output F, the same CO as output A	F: see output A							

ABB i-bus[®] KNX Commissioning

3.3.2 Communication objects *General*

These communication objects are only available once per device and serve the interdisciplinary (interoperable) functions.





No.	Function	Object name	Data type	Flags
0	In operation	General	1 bit DPT 1.002	C, R, T
<p>This communication object is enabled if in Parameter window General, page 24, the parameter <i>Send communication object "In operation"</i> is set with the option <i>yes</i>.</p> <p>In order to regularly monitor the presence of the device on the KNX, an in operation monitoring telegram can be sent cyclically on the bus.</p> <p>As long as the communication object is activated, it sends a programmable in operation telegram.</p>				
1	Request status values	General	1 bit DPT 1.017	C, W, T
<p>The communication object is enabled, if in Parameter window General, page 24, the parameter <i>Enable communication object "Request status values" 1 bit</i> is parameterized with the option <i>yes</i>.</p> <p>If a telegram with the value x (x = 0/1/0 or 1) is received on the communication object, all status communication objects are sent on the bus, as long as these have not been programmed with the option <i>after a change or request</i>.</p> <p>The following function results for the option x = 1:</p> <p>Telegram value: 1 = all status messages, provided they are programmed with the option <i>after a change or request</i>, are sent. 0 = no reaction.</p>				
2	Status manual operation	General	1 byte DPT 1.011	C, R, T
<p>This communication object is enabled, if in Parameter window Manual operation, page 26, the parameter <i>Enable communication object: "Status man. operation" 1 bit</i> has been parameterized with the option <i>yes</i>.</p> <p>Telegram value: 0 = manual operation not active 1 = manual operation active</p> <p>The status of manual operation is sent <i>after a change</i>, <i>after request</i> or <i>after a change and request</i> as programmed.</p>				
3	Disable/enable man. operation	General	1 bit DPT 1.003	C, R, W
<p>This communication object is enabled if in Parameter window Manual operation, page 26, the parameter <i>Manual operation</i> has been programmed with the option <i>disable/enable via communication object</i>.</p> <p>Manual operation of the device is blocked or enabled via this communication object.</p> <p>Using the value 0, the button  is blocked on the device. If the device is in manual operation mode, immediate switchover to KNX operation occurs.</p> <p>Using the value 1, the button  is enabled on the device.</p> <p>Telegram value: 0 = button  enabled 1 = button  disabled</p>				

ABB i-bus[®] KNX Commissioning

No.	Function	Object name	Data type	Flags
4	Reset overload/short circuit	General	1 bit DPT 1.015	C, W, T
<p>All active error messages are reset using this communication object.</p> <ul style="list-style-type: none"> • Communication object <i>Overload/short circuit</i> • Bit no. 1 <i>Short circuit</i> in status byte • Bit no. 2 <i>Overload test active</i> in status byte <p>Telegram value: 0 = no reaction 1 = all overload/short circuit messages are reset</p>				
5...9				
Not assigned				

ABB i-bus[®] KNX Commissioning

3.3.3

Communication objects *Output A*



No.	Function	Object name	Data type	Flags
10	Control value, switch	Output A	1 bit DPT 1.001	C, W
<p>This communication object is enabled if in Parameter window A: General, page 28, the parameter <i>Control value is received as</i> is set with the option <i>1 bit</i>. The VAS/S receives ON or OFF telegrams from the thermostat.</p> <p>Telegram value 0 = OFF 1 = ON</p>				
10	Control value, continuous (PWM)	Output A	1 byte DPT 5.001	C, W
<p>This communication object is enabled if in Parameter window A: General, page 28, the parameter <i>Control value is received as</i> is set with the option <i>1 byte</i>. The communication object value [0..255] determines the variable mark-to-space ratio of the valve drive. With communication object value 0 the output switches OFF (valve is closed with normally closed valve drive). With communication object value 255 the output switches ON permanently (valve is fully open with normally open valve drive).</p> <p>Telegram value 0 = OFF (valve drive closed) x = intermediate values 255 = ON (valve drive opened)</p>				
11	Overload/short circuit	Output A	1 bit DPT 1.005	C, R, T
<p>If there is a fault on an output, e.g. due to a short circuit or an overload, the yellow LED of the corresponding output will flash (5 Hz). At the same time, the communication object sends a telegram with the value 1. After the fault has been rectified with the button , the fault is reset on the output concerned and the communication object has the value 0. If the fault still persists, the LED will flash again, and the communication object has the value 1.</p> <p>As an alternative to button , the fault can be reset via communication object <i>Reset overload/short function</i> by a telegram with value 1.</p> <p>Telegram value: 0 = no overload/short circuit on the output 1 = overload/short circuit on the output</p>				
12				
Not assigned				
13	Fault control value	Output A	1 bit DPT 1.005	C, R, T
<p>This communication object is enabled if in Parameter window A: General, page 28, the parameter <i>Monitoring control values e.g. thermostat</i> is parameterized with the option <i>yes</i>. This communication object indicates a possible fault in the room thermostat. The communication objects <i>Control value, switch</i> or <i>Control value, continuous (PWM)</i> can be cyclically monitored. Should the control value not be received by the transmitting thermostat within a parameterizable time, a telegram with the value 1 is sent. The communication object value is sent – depending on the parameterization – after a change and/or on request via the communication object <i>Request status values</i>.</p> <p>Telegram value 0 = no fault 1 = fault</p>				



ABB i-bus[®] KNX Commissioning

No.	Function	Object name	Data type	Flags
14	Block	Output A	1 bit DPT 1.003	C, W
<p>The communication object is enabled, if in Parameter window A: Functions, page 33, the parameter <i>Enable communication object "Block" 1 bit</i> is parameterized with the option <i>yes</i>.</p> <p>The output is inhibited (blocked) and the current control value is retained via this communication object. Blocking of the output is implemented in accordance with the Priorities, page 50. Telegrams are still received during the block. The telegram last received is carried out after the block is removed.</p> <p>Telegram value: 0 = output not blocked 1 = output blocked</p>				
15	Forced operation	Output A	1 bit DPT 1.003	C, W
<p>The communication object is enabled, if in Parameter window A: Functions, page 33, the parameter <i>Enable communication object "Forced operation" 1 bit</i> is parameterized with the option <i>yes</i>.</p> <p>This communication object sets the output in a defined state and blocks it. If a telegram with the value 1 is received, forced operation is activated and the output implements the programmed control value in %. Telegrams are still received during the forced operation. If the value 0 is received, forced operation ends. The telegram last received is carried out, after forced operation has ended.</p> <p>Telegram value: 0 = end forced operation 1 = start forced operation</p>				
16	Trigger valve purge	Output A	1 bit DPT 1.003	C, W
<p>This communication object is enabled if in Parameter window A: Functions, page 33, the parameter <i>Enable valve purge</i> is set with the option <i>yes</i>.</p> <p>Valve purge is triggered using this communication object.</p> <p>Telegram value: 0 = end valve purge, valve will be closed 1 = start valve purge, valve will be opened</p> <p>The purging cycle time is restarted if automatic valve purge has been activated at start-up of the device. The purging cycle time will be restarted at the end of the actual purging period. The parameterized valve purging duration is included here.</p> <p>If the valve purge currently active is interrupted by a manual valve purge or a set value that achieves the parameterized purge value, the purge cycle time is restarted.</p> <p>If the active purge duration was less than the parameterized purge duration, this will not be taken into consideration. In this case, the actual purge cycle time is shorter in duration by the active purge duration.</p> <div style="border: 1px solid black; padding: 5px; margin-top: 10px;"> <p>Note</p> <p>A valve purge not undertaken due to a higher priority will no longer be undertaken. The following functions are executed with telegram value 0.</p> <ul style="list-style-type: none"> • A valve purge currently under way is interrupted. • The purge cycle with automatic valve purge will be restarted. </div>				

ABB i-bus[®] KNX Commissioning

No.	Function	Object name	Data type	Flags
17	Status valve purge	Output A	1 bit DPT 1.003	C, R, T
<p>This communication object is enabled if in Parameter window A: Functions, page 33, the parameter <i>Enable valve purge</i> has been parameterized with the option <i>yes</i> and the parameter <i>Enable communication object</i> "Status valve purge" 1 bit has been parameterized with the option <i>yes</i>.</p> <p>This communication object indicates the status of valve purge.</p> <p>The status is sent if</p> <ul style="list-style-type: none"> • a request is received via the communication object <i>Request status values</i> and the parameter <i>on request or after a change or request</i> is present. • the communication object value has changed, and the parameter <i>on request or after a change or request</i> is present. • a read request is carried out on this communication object. <p>Telegram value: 0 = valve purge inactive 1 = valve purge active</p> <div style="border: 1px solid black; padding: 5px; margin: 10px 0;"> <p>Note</p> <p>The status is displayed as soon as a valve purge has been activated. The status remains active, even when the valve purge has been interrupted, e.g. by a priority.</p> </div>				
18	Status control value	Output A	1 byte DPT 5.001	C, R, T
<p>This communication object is enabled if in Parameter window A: Functions, page 33, the parameter <i>Enable communication object</i> "Status control value" is set with the option <i>1 byte</i>.</p> <p>The control status of the output is sent via this communication object. Hereby, the limit position that the valve should assume is transferred.</p> <p>The LED of the corresponding output indicates the same value as the status.</p> <p>The status is sent if</p> <ul style="list-style-type: none"> • a request is received via the communication object <i>Request status values</i> and the parameter <i>on request or after a change or request</i> is present. • the communication object value has changed and the parameter <i>on request or after a change or request</i> is present. • a read request is carried out on this communication object. <p>Telegram value: 0...255 = control is displayed directly as a figure value At 0 = LED ● off At > 0 = LED ● on</p> <p>If in parameter window <i>General</i> under parameter <i>Control value is received as the option 1 bit</i> is selected, the following applies for the communication object <i>Status control value 1 byte</i>:</p> <p>Telegram value: 0 = control value 0; LED ● off 255 = control value 1; LED ● on</p>				

ABB i-bus[®] KNX Commissioning

No.	Function	Object name	Data type	Flags
18	Status control value	Output A	1 bit: DPT 1.011	C, R, T
<p>This communication object is enabled if in Parameter window A: Functions, page 33, the parameter <i>Enable communication object "Status control value"</i> is set with the option <i>1 bit</i>.</p> <p>The control status of the output is sent via this communication object.</p> <p>The LED of the corresponding outputs indicates the same value as the status.</p> <p>The status is sent if</p> <ul style="list-style-type: none"> a request is received via the communication object <i>Request status values</i> and the parameter <i>on request or after a change or request</i> is present. the communication object value has changed and the parameter <i>on request or after a change or request</i> is present. a read request is carried out on this communication object. <p>Telegram value: 0 = control equal to zero; LED  off 1 = control not equal to zero; LED  on</p>				
19	Status byte	Output A	1 byte (NON DPT)	C, R, T
<p>Using the status byte, status information for diagnostic purposes can be read for each output. The current status or communication object value is sent after a request by the communication object <i>Request status values</i>. The communication object is always displayed.</p> <p>The value of the status byte can be decoded using the Code table, page 52.</p> <p>Bit 0: Control > 0 Telegram value 0: Control = 0 Telegram value 1: Control > 0</p> <p>Bit 1: Short-circuit Telegram value: 0 = no short circuit Telegram value 1: Short circuit</p> <p>Bit 2: Overload test Telegram value 0: no overload Telegram value 1: Overload</p> <p>Bit 3: Purging Telegram value 0: Valve purge inactive Telegram value 1: Valve purge active</p> <p>Bit 4: Not assigned</p> <p>Bit 5: Manual operation Telegram value 0: manual operation inactive Telegram value 1: manual operation active</p> <p>Bit 6: Forced operation active Telegram value 0: forced operation inactive Telegram value 1: forced operation active</p> <p>Bit 7: Blocking active Telegram value 0: Blocking inactive Telegram value 1: Blocking active</p>				
20-29 30-39 40-49 50-59 60-69	See Output A			

4 Planning and Application

In this section, you will find useful instructions concerning the planning and application of the Valve Drive Actuator. Application examples and practical tips on the topic of temperature control etc. can be found in the *Application manual Heating/Ventilation/Air-Conditioning* at www.abb.de/knx.

4.1 Behaviour during a malfunction

Fuse

Three outputs each (e.g. A, B, C) are internally protected in the device with a fuse. The fuse trips as soon as a fault (short-circuit or overload) has been detected. All outputs of a group (e.g. A, B, C) are switched off and sent a telegram with the value 1 via the communication object *Overload/Short circuit* by. An active PWM control is interrupted.

Note

The response at short circuit and overload has the highest priority and deactivates an active manual operation as well as an active safety function (forced operation or blocking) of an output in the respective output group.
In case of a short circuit or overload the installation must be inspected and the fault remedied.

Test

After a fuse cooling time (about 25 seconds), the test of the outputs commences. For this purpose, the outputs are switched on consecutively for about 4 seconds (LED on the output to be tested is on) and tested for a short circuit. During the test, the red LED  flashes slowly (SF = 1 Hz). The test is also performed on the outputs of a group, which are not parameterized or at which a *Forced operation* or function *Blocking* is active. The test for the outputs of a group can take up to 60 seconds. The duration is dependent on the temperature and the current flow in the event of a short circuit or an overload.

Reaction of the output after positive short circuit test

If the test has ended for all three outputs of a group, and at least one of the outputs has a short circuit, the other outputs are enabled again and continue to operate normally.

The output that has the short circuit is switched off or blocked.

The bit no. 1 *Short circuit* in the status byte of the output or outputs concerned is set to 1.



The communication objects *Overload/short circuit* of the outputs not concerned send a telegram with the value 0.

ABB i-bus[®] KNX

Planning and Application

Reaction of the output after negative short-circuit test (no short circuit test)

If a short circuit could not be determined after the fuse trips and the three outputs are tested, after about 40 seconds the 3 outputs of a group are checked for a possible overload. A 7 day test cycle commences. Should the fuse trip 3 times within a period of 7 days, but a short circuit is not determined on any of the outputs, an overload is assumed. Then all 3 outputs of a group are switched off or blocked. The red LED and the output LEDs of the output group concerned flash quickly (5 Hz). The bit no. 2 *Overload* in the status byte of the output or outputs concerned is set to 1.

For all outputs of the group, the communication objects *Overload/short circuit* are written with a 1. In this case, the reason for the overload, e.g. to many valve drives, must be remedied. Subsequently, on the corresponding group of outputs, the outputs will need to be reset via the button  or via the device communication object no. 4 *Reset overload/short circuit*. The red LED  goes off. The outputs operate in normal operation, and the LEDs indicate the respective status.

If a fault does not re-occur within a 7 day period, the test cycle is automatically reset. The communication objects *Overload/short circuit* and bit no. 2 in the status byte of the output or outputs concerned is set to 0.





 X	 Y	 Z	 X-Z	Remark FF = Fast flashing (5 Hz). SF = Slow flashing (1 Hz):
FF	FF	FF	On	Overload detected. All outputs of the group concerned are blocked or switched off.

ABB i-bus[®] KNX

Planning and Application

4.2 Bus voltage recovery

General

- A control value can be predefined at bus voltage recovery. The corresponding communication object values are set, see [Table](#) page 50.
- Time-dependent functions are non-functional and must be restarted, e.g. valve purge.
- Status communication objects are sent as long as the option *after a change* or *after a change or request* has been set.
- The send delay is only active at bus voltage recovery!
- Forced operation is re-established and executed as a priority. All other priorities, e.g. blocking and valve purge are reset.

Control of valve drives

- The purge cycle restarts (if activated).
- The value parameterized for bus voltage recovery is set with the control value priority and will be replaced if a new control value is received.

4.3 ETS reset

What is an ETS reset?

Generally an ETS reset is defined as a reset of the device via the ETS. The ETS Reset is initiated in the ETS3 under the menu point *Commissioning* with the function *Reset device*. The application program is stopped and restarted, i.e. all the states set beforehand are lost. The device is reset to the original state (control value 0 % and timer are restarted).

4.4 Download (DL)

The communication object value of the control value remains unchanged with a download. During the download, the output behaves just as it would at bus voltage failure. After a download, the value active before the download will be set again. Timers remain stationary and will be restarted. Status values of the control values are updated and sent.

Note
After a download with a change, the parameter complies in behaviour to a reset of the device in the ETS. If a download of the application is again undertaken (full download) after a full discharge, the behaviour is the same as after an ETS reset. After the application is removed or after an interrupted download, manual operation no longer functions.

ABB i-bus[®] KNX

Planning and Application

4.5 Bus voltage failure

The device can no longer be controlled at a bus voltage failure. The outputs switch off and the valve drives assume their position in a no-current state (open or closed). Manual operation is not possible during a bus voltage failure.

4.6 Reaction at bus voltage recovery, download and reset

Behaviour	At bus voltage recovery	At download (DL)	At reset
Output control	Parameterizable preferred position at bus voltage recovery is set	Control with the communication object value before download	Off
Monitoring control value	Monitoring time will be restarted	Monitoring time will be restarted. Communication object value unchanged	Monitoring time will be restarted. Communication object value is reset
Forced operation	Active, provided that forced operation was also active before bus voltage failure	Inactive, communication object value is reset	Inactive, communication object value is reset
Block	Inactive, communication object value is reset	Inactive, communication object value is reset	Inactive, communication object value is reset
Valve purge	Valve purge is inactive. Communication object value <i>Status valve purge</i> = 0. Injection cycle time restarts (provided that automatic valve purging is activated)	Valve purge is inactive. Communication object value <i>Status valve purge</i> = 0. Injection cycle time restarts (provided that automatic valve purging is activated)	Valve purge is inactive. Communication object value <i>Status valve purge</i> = 0. Injection cycle time restarts (provided that automatic valve purging is activated)
Manual operation	Can be parameterized	Can be parameterized	Can be parameterized

4.7 Priorities

The priorities for telegram processing are defined as follows:

1. Overload/short circuit current
2. Bus voltage failure/recovery
3. Manual operation
4. Block
5. Forced operation
6. Valve purge
7. Control value after control fault
8. Control values (1 bit/byte)

Note
1 corresponds to the highest priority.

A **Appendix**

A.1 **Scope of delivery**

The Valve Drive Actuator is supplied together with the following components. Please check the items received using the following list.

- 1 x VAA/S x.230.2.1, Valve Drive Actuator, x-fold, 230 V, MDRC
- 1 x installation and operating instructions
- 1 x bus connection terminal (red/black)
- 1 x label carrier

A.3 Ordering Information

Device type	Product name	Order code	bbn 40 16779 EAN	Price group	Weight 1 pcs [kg]	Pack unit [Pcs]
VAA/S 6.230.2.1	Valve Drive Actuator, 6-fold, 230 V, MDRC	2CDG 110 116 R0011	82986 1	P2	0.16	1
VAA/S 12.230.2.1	Valve Drive Actuator, 12-fold, 230 V, MDRC	2CDG 110 117 R0011	82987 8	P2	0.28	1

A.4 Accessories

Device type	Product name	Order code	bbn 40 16779 EAN	Price group	Weight 1 pcs [kg]	Pack unit [Pcs]
TSA/K 230.1	Electrothermal Valve Drive, 230 V, Normally Closed	2CDG 110 007 R0011	65299 5	20	0.1	1
TSA/K 24.1	Electrothermal Valve Drive, 24 V, Normally Closed	2CDG 110 008 R0011	65300 8	20	0.1	1
VA/Z 10.1	Valve Adapter (M30 x 1.5) for Dumser, Chronatherm, Vescal, KaMo	2CDG 110 009 R0011	65319 0	20	0.01	1
VA/Z 50.1	Valve Adapter (M30 x 1.5) for Honeywell, Reich, Cazzaniga, Landis & Gyr. MNG	2CDG 110 010 R0011	65320 6	20	0.01	1
VA/Z 78.1	Valve Adapter (Flange) for Danfoss RA	2CDG 110 011 R0011	65321 3	20	0.01	1
VA/Z 80.1	Valve Adapter (M30 x 1.5) for Heimeier, Herb, Onda, Schlösser (from 93), Oventrop	2CDG 110 012 R0011	65322 0	20	0.01	1

ABB i-bus[®] KNX Appendix

A.5 Notes

ABB i-bus[®] KNX Appendix

Notes

ABB i-bus[®] KNX Appendix

Notes

Contact

ABB STOTZ-KONTAKT GmbH

Eppelheimer Straße 82

69123 Heidelberg, Germany

Phone: +49 (0)6221 701 607 (Marketing)

+49 (0)6221 701 434 (KNX Helpline)

Fax: +49 (0)6221 701 724

e-mail: knx.marketing@de.abb.com

knx.helpline@de.abb.com

Further information and local contacts:

www.abb.com/knx

Note:

We reserve the right to make technical changes or modify the contents of this document without prior notice.

With regard to purchase orders, the agreed particulars shall prevail. ABB AG shall not be liable for any consequences arising from errors or incomplete information in this document.

We reserve the rights to this document and in the subject matter and illustrations contained therein. Any reproduction, disclosure to third parties or utilization of its content – in whole or in parts – is forbidden without prior written consent of ABB AG.

Copyright© 2012 ABB

All rights reserved