

Instruction Manual

# Integra

AV Receiver

DRX-2.4

## Table of contents

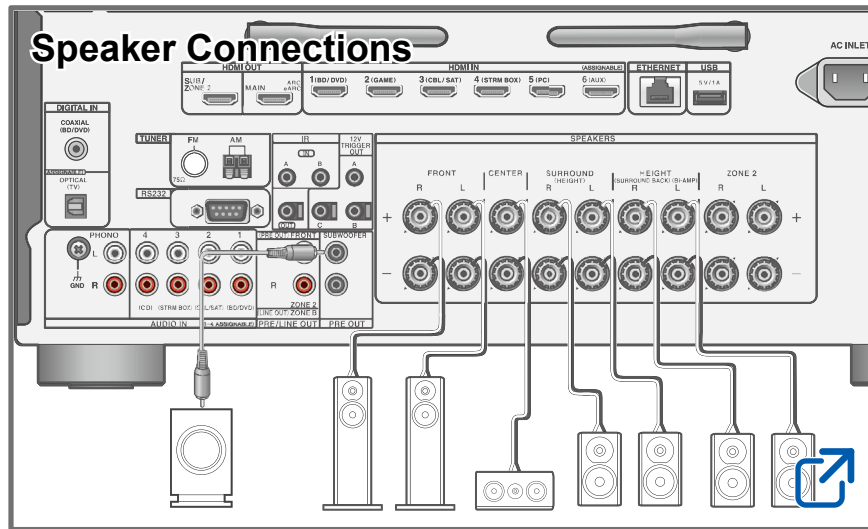
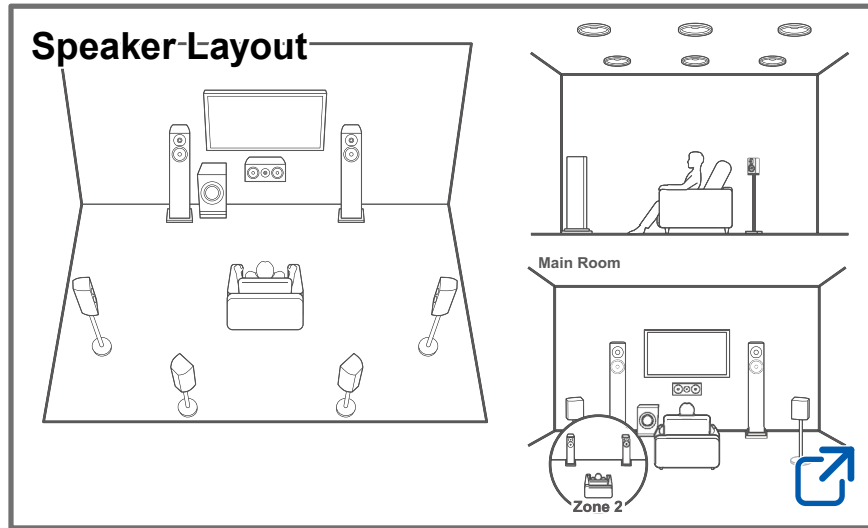

## Firmware Update



## Troubleshooting



## Supplementary Information



## Reducing the Power Consumption in Standby State

When the following functions are enabled, the power consumption in standby state increases. To reduce the power consumption in standby state, check each setting and set the functions to "Off".

- HDMI CEC ( →[p114](#))
- HDMI Standby Through ( →[p114](#))
- USB Power Out at Standby ( →[p121](#))
- Network Standby ( →[p121](#))
- Bluetooth Wakeup ( →[p122](#))

Detailed contents (Next page)



|                                                      |           |
|------------------------------------------------------|-----------|
| <b>Before starting the procedure</b>                 | <b>6</b>  |
| <b>Firmware Update</b>                               | <b>7</b>  |
| Update Information of the firmware                   | 7         |
| Firmware Update Procedure                            | 7         |
| <b>Part Names</b>                                    | <b>10</b> |
| Front Panel                                          | 10        |
| Display                                              | 12        |
| Rear Panel                                           | 13        |
| Remote Controller                                    | 15        |
| <b>Inputting Characters</b>                          | <b>17</b> |
| <b>Speaker Layout</b>                                |           |
| The listening room and the speaker layout            | 19        |
| 3.1 Channel System                                   | 20        |
| 5.1 Channel System                                   | 21        |
| 7.1 Channel System                                   | 22        |
| 3.1.2 Channel System                                 | 23        |
| 5.1.2 Channel System                                 | 24        |
| <b>Speaker Installation</b>                          |           |
| <b>Speaker Connections</b>                           |           |
| Speaker Connections and "Speaker Impedance" Settings | 31        |
| Connecting a Power Amplifier                         | 46        |

## Connections

|                                                                              |           |
|------------------------------------------------------------------------------|-----------|
| <b>Connecting the TV</b>                                                     | <b>48</b> |
| To ARC/eARC TV                                                               | 48        |
| To Non-ARC TV                                                                | 48        |
| <b>Connecting the SUB Monitor</b>                                            | <b>49</b> |
| SUB Monitor                                                                  | 49        |
| <b>Connecting Playback Devices</b>                                           | <b>50</b> |
| Connecting an AV Component with HDMI Jack Mounted                            | 50        |
| Connecting an Audio Component                                                | 51        |
| <b>Connecting an AV Component in a Separate Room (Multi-zone Connection)</b> | <b>52</b> |
| Connecting a TV (ZONE 2)                                                     | 52        |
| Connecting an Integrated Amplifier (ZONE 2)                                  | 53        |
| <b>Connecting Antennas</b>                                                   | <b>54</b> |
| <b>Network Connection</b>                                                    | <b>55</b> |
| <b>Connecting External Control Devices</b>                                   | <b>56</b> |
| IR IN/OUT port                                                               | 56        |
| 12V TRIGGER OUT jack                                                         | 57        |
| <b>Connecting the Power Cord</b>                                             | <b>58</b> |
| <b>Playback</b>                                                              |           |
| <b>AV Component Playback</b>                                                 | <b>60</b> |
| Basic Operations                                                             | 60        |



|                                                                                    |           |                                                          |           |
|------------------------------------------------------------------------------------|-----------|----------------------------------------------------------|-----------|
| <b>BLUETOOTH® Playback</b>                                                         | <b>61</b> |                                                          |           |
| Playing audio from BLUETOOTH wireless technology enabled devices with this unit    | 61        |                                                          |           |
| Transmitting audio from this unit to BLUETOOTH wireless technology enabled devices | 62        |                                                          |           |
| <b>Listening To the Radio</b>                                                      | <b>64</b> |                                                          |           |
| Listening To the AM/FM Radio                                                       | 64        |                                                          |           |
| Presetting a Radio Station                                                         | 67        |                                                          |           |
| <b>Listening Mode</b>                                                              | <b>68</b> |                                                          |           |
| Selecting a Listening mode                                                         | 68        |                                                          |           |
| <b>Quick Menu</b>                                                                  | <b>70</b> |                                                          |           |
| Menu operations                                                                    | 70        |                                                          |           |
| <b>Spotify</b>                                                                     | <b>72</b> |                                                          |           |
| <b>AirPlay®</b>                                                                    | <b>73</b> |                                                          |           |
| Basic Operations                                                                   | 73        |                                                          |           |
| Playing Back on multiple devices (AirPlay2)                                        | 74        |                                                          |           |
| <b>DTS Play-Fi®</b>                                                                | <b>75</b> |                                                          |           |
| Playing Back                                                                       | 75        |                                                          |           |
| <b>Amazon Alexa</b>                                                                | <b>76</b> |                                                          |           |
| Registering this unit with an Amazon account                                       | 76        |                                                          |           |
| Operating this unit                                                                | 77        |                                                          |           |
| <b>Amazon Music</b>                                                                | <b>78</b> |                                                          |           |
| Registering This Unit with Amazon Music                                            | 78        |                                                          |           |
| Playing Amazon Music using the Integra Control Pro                                 | 79        |                                                          |           |
|                                                                                    |           | Playing Amazon Music using the remote controller         | 79        |
|                                                                                    |           | <b>Connecting the Sonos System for Playback</b>          | <b>80</b> |
|                                                                                    |           | Necessary Equipment                                      | 80        |
|                                                                                    |           | How to Connect This Unit and Sonos Connect               | 80        |
|                                                                                    |           | Setting Up                                               | 80        |
|                                                                                    |           | Playing Sonos on This Unit                               | 81        |
|                                                                                    |           | <b>Internet Radio</b>                                    | <b>82</b> |
|                                                                                    |           | Playing Back                                             | 82        |
|                                                                                    |           | <b>Multi-zone</b>                                        | <b>84</b> |
|                                                                                    |           | Playing Back                                             | 85        |
|                                                                                    |           | <b>Playing different audio and video</b>                 | <b>87</b> |
|                                                                                    |           | Displaying Your Favorite Video on TV While Playing Music | 87        |
|                                                                                    |           | <b>USB Storage Device</b>                                | <b>88</b> |
|                                                                                    |           | Supported Audio Formats                                  | 88        |
|                                                                                    |           | USB Storage Device Requirements                          | 88        |
|                                                                                    |           | Playing music files saved on a USB storage device        | 89        |
|                                                                                    |           | <b>Music Server</b>                                      | <b>91</b> |
|                                                                                    |           | Supported Audio Formats                                  | 91        |
|                                                                                    |           | Windows Media® Player 12 settings                        | 91        |
|                                                                                    |           | Playing Back                                             | 92        |
|                                                                                    |           | <b>Play Queue</b>                                        | <b>94</b> |
|                                                                                    |           | Adding Play Queue Information                            | 94        |
|                                                                                    |           | Sort and Delete                                          | 94        |



|                                              |           |
|----------------------------------------------|-----------|
| Playing Back                                 | 95        |
| <b>Connecting a transmitter for playback</b> | <b>96</b> |
| Connections                                  | 96        |
| Setting Up                                   | 96        |
| Playing Back                                 | 96        |

## Setup

|                                                |            |
|------------------------------------------------|------------|
| <b>Setup Menu</b>                              | <b>98</b>  |
| Menu list                                      | 98         |
| 1. Input/Output Assign                         | 100        |
| 2. Speaker                                     | 104        |
| 3. Audio Adjust                                | 109        |
| 4. Source                                      | 111        |
| 5. Listening Mode Preset                       | 113        |
| 6. Hardware                                    | 114        |
| 7. Multi Zone                                  | 125        |
| 8. Miscellaneous                               | 126        |
| <b>Web Setup</b>                               | <b>128</b> |
| Menu operations                                | 128        |
| <b>Initial Setup with Auto Start-up Wizard</b> | <b>129</b> |
| Operations                                     | 129        |
| <b>Integra Control Pro</b>                     | <b>132</b> |
| Main features                                  | 132        |
| Initial Setup                                  | 132        |

## Troubleshooting

|                                        |     |
|----------------------------------------|-----|
| When the unit is operating erratically | 134 |
| Troubleshooting                        | 135 |

## Appendix

|                                                       |     |
|-------------------------------------------------------|-----|
| Speaker Layouts and Selectable Listening Modes        | 145 |
| Listening Mode buttons and Selectable Listening Modes | 148 |
| Input Formats and Selectable Listening Modes          | 150 |
| Listening Mode Effects                                | 154 |
| Speaker Combinations                                  | 158 |

|                               |            |
|-------------------------------|------------|
| <b>General Specifications</b> | <b>159</b> |
|-------------------------------|------------|



# Before starting the procedure

## What's in the box

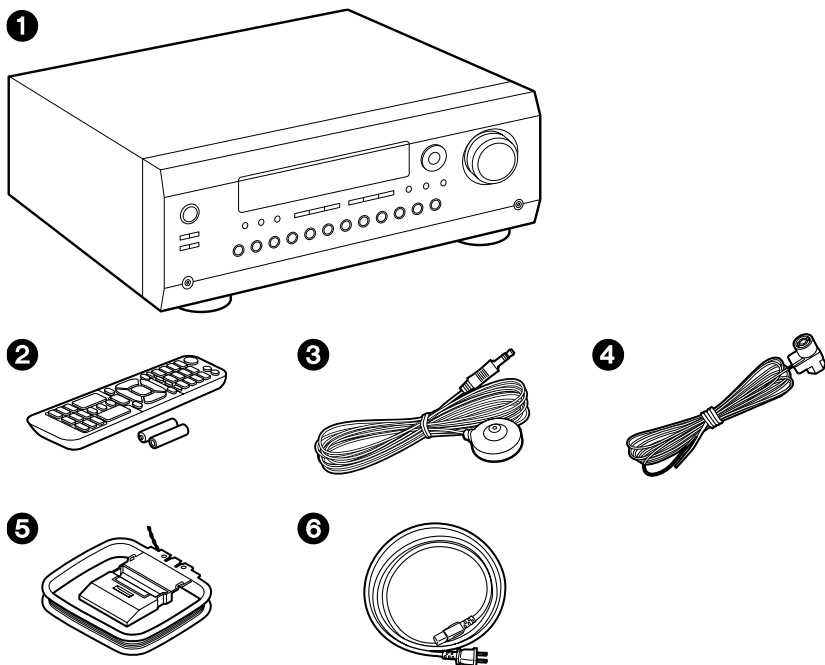

1. Main unit (1)
2. Remote controller (RC-973R) (1), Batteries (AAA/R03) (2)
3. Speaker setup microphone (1)
  - Used during Initial Setup.
4. Indoor FM antenna (1)
5. AM loop antenna (1)
6. Power cord (1)
  - Initial Setup Guide (1)
    - \* This is an online user manual. This is not supplied with the product.

## Note

- Connect speakers with an impedance of 4  $\Omega$  to 16  $\Omega$ .
- The power cord must be connected only after all other connections are completed.
- We will not accept any responsibility for damage arising from the connection with equipment manufactured by other companies.
- Network services and content that can be used may no longer be available if new functions are added by updating firmware or the service providers terminate their services. Also, available services may differ depending on your area.
- Details on the firmware update will be posted on our website and through other means at a later date.
- Specifications and appearance are subject to change without prior notice.



# Firmware Update

This unit is equipped with a function to update the firmware via network or USB port when the firmware update is announced after purchase. This enables various functions to be added and operations to be improved.

Depending on the manufacturing timing of the product, the firmware may be switched to the updated one. In such a case, new functions may be added from the start. For how to confirm the latest firmware contents and the firmware version of your product, see the following section.

## Update Information of the firmware

For the latest firmware contents and the firmware version, visit our company's website. If the firmware version of your product differs from the latest one, it is recommended to update the firmware.

To confirm the firmware version of your product, press the  button on the remote controller, and refer to "8. Miscellaneous" - "Firmware Update" - "Version" (→[p126](#)).

## Firmware Update Procedure

The update may take approx. 20 minutes to complete via network or via USB port. Existing settings are guaranteed in either updating method.

When this unit is connected to the network, notifications of firmware updates may be displayed. To update the firmware, select "Update Now" with the cursor buttons of the remote controller and press Enter. The unit automatically enters standby mode after "Completed!" is displayed, and the update is completed.

**Disclaimer:** The program and accompanying online documentation are furnished to you for use at your own risk.



Our company will not be liable and you will have no remedy for damages for any claim of any kind whatsoever concerning your use of the program or the accompanying online documentation, regardless of legal theory, and whether arising in tort or contract.

In no event will our company be liable to you or any third party for any special, indirect, incidental, or consequential damages of any kind, including, but not limited to, compensation, reimbursement or damages on account of the loss of present or prospective profits, loss of data, or for any other reason whatsoever.

## Updating the Firmware via Network

- While updating the firmware, do not do the following:
    - Disconnecting and reconnecting cables, USB storage device, speaker setup microphone or headphones, or performing operations on the unit such as turning the power off
    - Accessing this unit from a PC or smartphone using their applications
  - Check that the unit is turned on, and the connection to the Internet is secured.
  - Turn off control devices (PC etc.) connected to the network.
  - Stop an Internet radio, USB storage device, or server content being played.
  - If the multi-zone function is active, turn it off.
  - If "HDMI CEC" is set to "On", set it to "Off".
    - Press . Next, select "6. Hardware" - "HDMI" and press Enter, then select "HDMI CEC" and select "Off".
- \* The descriptions may differ from the actual on-screen displays, however, operations and functions are the same.

### Update

1. Press .  
The Setup menu is displayed on the TV screen.
2. Select "8. Miscellaneous" - "Firmware Update" - "Update via NET" with the cursors in order, then press Enter.
  - If "Firmware Update" is grayed out and cannot be selected, wait for a while until it starts up.
  - If there is no updatable firmware, "Update via NET" cannot be selected.
3. Press Enter with "Update" selected, and start update.
  - During the update, the TV screen may go black depending on the program to be updated. In such a case, check the progress on the display of the unit. The TV screen will remain black until the update is completed and the power is turned on again.
  - When "Completed!" is displayed, the update is complete.
4. Press  On/Standby on the main unit to turn the unit into standby mode. The process is completed, and your firmware is updated to the latest version.
  - Do not use  on the remote controller.

### If an Error Message is Displayed

If an error occurs, "\*-\*-\* Error!" is displayed on the display of the unit. ("\*"



represents an alphanumeric character.) Refer to the following descriptions and check.

#### Error Code

- \*-01, \*-10:  
Ethernet cable not found. Connect the Ethernet cable properly.
- \*-02, \*-03, \*-04, \*-05, \*-06, \*-11, \*-13, \*-14, \*-16, \*-17, \*-18, \*-20, \*-21:  
Internet connection error. Check the following:
  - Whether the router is turned on
  - Whether this unit and the router are connected via the networkUnplug and plug the power cords of this unit and the router. This may solve the problem. If you are still unable to connect to the Internet, the DNS server or proxy server may be temporarily down. Check the server operation status with your Internet service provider.
- Others:  
After removing the power plug once, insert it to the outlet, and then start the operation from the beginning.

## Updating via USB



- While updating the firmware, do not do the following:
  - Disconnecting and reconnecting cables, USB storage device, speaker setup microphone or headphones, or performing operations on the unit such as turning the power off
  - Accessing this unit from a PC or smartphone using their applications
- Prepare a 256 MB or larger USB storage device. The format of USB storage devices supports FAT16 or FAT32 file system format.
  - Media inserted into a USB card reader may not be used for this function.
  - USB storage devices equipped with the security function are not supported.
  - USB hubs and USB devices equipped with the hub function are not supported. Do not connect these devices to the unit.
- Delete any data stored on the USB storage device.
- Turn off control devices (PC etc.) connected to the network.
- Stop an Internet radio, USB storage device, or server content being played.
- If the multi-zone function is active, turn it off.
- If "HDMI CEC" is set to "On", set it to "Off".
  - Press . Next, select "6. Hardware" - "HDMI" and press Enter, then select "HDMI CEC" and select "Off".
- \* Depending on the USB storage device or its content, long time may be required for loading, the content may not be loaded correctly, or power may not be supplied correctly.
- \* Our company will not be liable whatsoever for any loss or damage of data, or storage failure arising from the use of the USB storage device. Please note this in advance.
- \* The descriptions may differ from the actual on-screen displays, however, operations and functions are the same.

### Update

1. Connect the USB storage device to your PC.
2. Download the firmware file from the our company's website to your PC and unzip.  
Firmware files are named as below.  
ONKAVR\*\*\*\*\_R\*\*\*.zip  
Unzip the file on your PC. The number of unzipped files and folders varies depending on the model.
3. Copy all unzipped files and folders to the root folder of the USB storage device.
  - Make sure to copy the unzipped files.





4. Connect the USB storage device to the USB port of this unit.
  - If an AC adapter is supplied with the USB storage device, connect the AC adapter, and use it with a household outlet.
  - If the USB storage device has been partitioned, each section will be treated as an independent device.
5. Press .  
The Setup menu is displayed on the TV screen.
6. Select "8. Miscellaneous" - "Firmware Update" - "Update via USB" with the cursors in order, then press Enter.
  - If "Firmware Update" is grayed out and cannot be selected, wait for a while until it starts up.
  - If there is no updatable firmware, "Update via USB" cannot be selected.
7. Press Enter with "Update" selected, and start update.
  - During the update, the TV screen may go black depending on the program to be updated. In such a case, check the progress on the display of the unit. The TV screen will remain black until the update is completed and the power is turned on again.
  - During the update, do not turn the power off, or disconnect or reconnect the USB storage device.
  - When "Completed!" is displayed, the update is complete.
8. Disconnect the USB storage device from the unit.
9. Press  On/Standby on the main unit to turn the unit into standby mode. The process is completed, and your firmware is updated to the latest version.
  - Do not use  on the remote controller.

- Others:  
After removing the power plug once, insert it to the outlet, and then start the operation from the beginning.

### If an Error Message is Displayed

If an error occurs, "\*-\*-\* Error!" is displayed on the display of the unit. ("\*" represents an alphanumeric character.) Refer to the following descriptions and check.

#### Error Code

- \*-01, \*-10:  
The USB storage device cannot be recognized. Check if the USB storage device or USB cable is securely inserted to the USB port of the unit. Connect the USB storage device to an external power source if it has its own power supply.
- \*-05, \*-13, \*-20, \*-21:  
The firmware file is not present in the root folder of the USB storage device, or the firmware file is for another model. Retry from the download of the firmware file.



# Part Names

## Front Panel

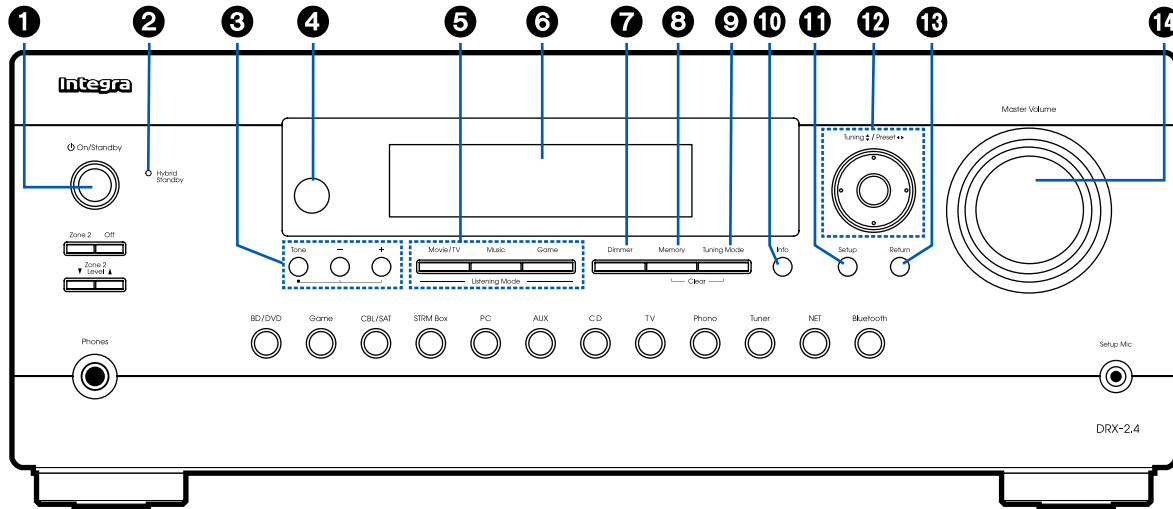

1. **On/Standby button**

2. **Hybrid Standby indicator:** Lights up when any of the following functions is working or enabled in standby state of this unit. When this indicator is lighting, the power consumption in standby state increases, however, the increase in power consumption is minimized by entering the Hybrid Standby mode where only the essential circuits operate.

– HDMI CEC ( →[p114](#))

– HDMI Standby Through ( →[p114](#))

– USB Power Out at Standby ( →[p121](#))

– Network Standby ( →[p121](#))

– Bluetooth Wakeup ( →[p122](#))

3. **Tone button:** You can adjust the sound quality of the speakers. Press the Tone button to select an item to adjust from "Bass", "Vocal" and "Treble", and press + and - to adjust.

4. **Remote control sensor:** Receives signals from the remote controller.

• The reception range of the remote controller is within a distance of approx. 16/5 m, and an angle of 20° in vertical direction and 30° to right and left.

5. **Listening Mode button:** Press "Movie/TV", "Music" or "Game" button to change the listening mode. ( →[p68](#))

6. **Display** ( →[p12](#))

7. **Dimmer button:** Switches the brightness of the display with three levels. It cannot be turned off completely.

8. **Memory button:** Used to register AM/FM radio stations. ( →[p67](#))

9. **Tuning Mode button:** Switches the tuning mode. ( →[p64](#))

10. **Info button:** Switches the information on the display. ( →[p69](#))

11. **Setup button:** You can display advanced setting items on the TV and the display to have a more enjoyable experience with this unit. ( →[p97](#))

12. **Cursor buttons (▲ / ▼ / ◀ / ▶) and Enter button:** Select an item with the cursors, and press Enter to confirm your selection. When using Tuner, use them to tune in to stations. ( →[p64](#))

13. **Return button:** Returns the display to the previous state while setting.

14. **Master Volume**



# Front Panel

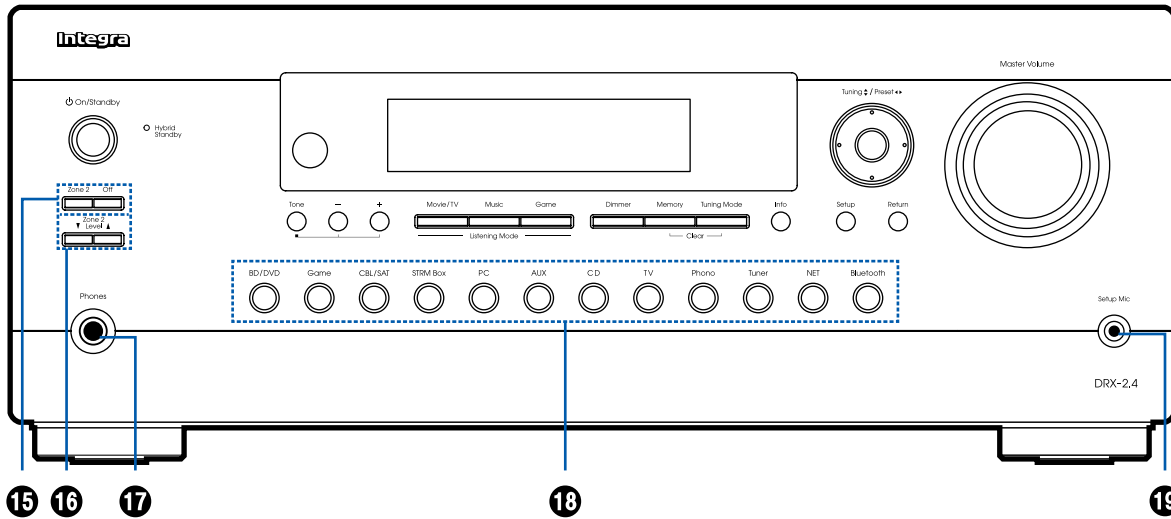

- 15. **Zone 2 button:** Controls the multi-zone function. ( →[p85](#) )  
**Off button:** Switches the multi-zone function off. ( →[p85](#) )
- 16. **Zone 2 Level ▲ / ▼ buttons:** Adjust the volume of the multi-zone function. ( →[p85](#) )
- 17. **Phones jack:** Connect headphones with a standard plug (ø1/4"/6.3 mm).
- 18. **Input selector buttons:** Switches the input to be played.

- 19. **Setup Mic jack:** Connect the supplied speaker setup microphone. ( →[p131](#) )



# Display

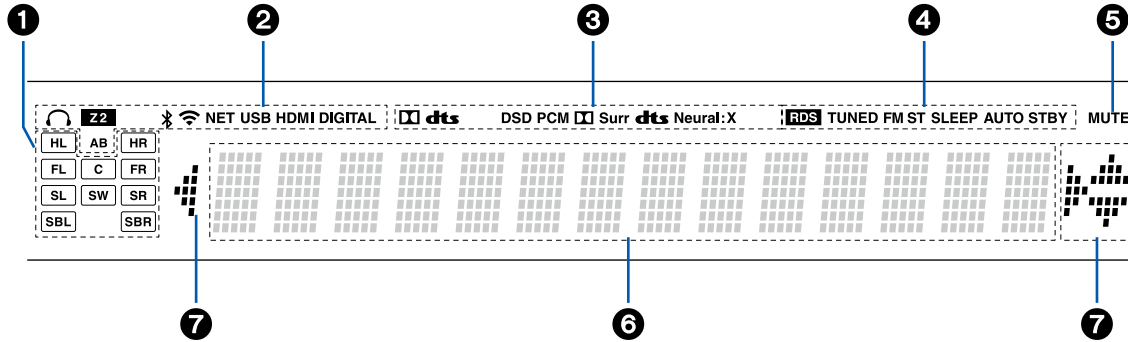

- 1. Speaker/Channel display:** Displays the output channel that corresponds to the selected listening mode.
- Lights in the following conditions.
  - 🎧: Headphones are connected.
  - Z2:** ZONE 2 is on.
  - 📶: Connected by BLUETOOTH.
  - 📶: Connected by Wi-Fi.
  - NET:** Lights when connected to the network with the "NET" input selector. It will blink if incorrectly

connected to the network.

**USB:** Lights when the "NET" input selector is selected, a USB device is connected and the USB input is selected. It will blink if the USB device is not properly connected.

**HDMI:** HDMI signals are input and the HDMI input is selected.

**DIGITAL:** Digital signals are input and the digital input is selected.

**A:** Audio is output only to ZONE A.

**B:** Audio is output only to ZONE B.

**AB:** Audio is output to both ZONE A and ZONE B.

- Lights according to the type of input digital audio signal and the listening mode.
- Lights in the following conditions.
  - RDS** (Australian and Asian models): Receiving RDS broadcasting.
  - TUNED:** Receiving AM/FM radio
  - FM ST:** Receiving FM stereo
  - SLEEP:** Sleep timer is set.
  - AUTO STBY:** Auto Standby is set. ( → [p121](#))
- Blinks when muting is on.
- Displays various information of the input signals.
- Cursors** (▲ / ▼ / ◀ / ▶): These may light when performing operations while "NET" is selected with the input selector. ▲ / ▼ light when there are multiple folders or files that are available to be selected. ◀ / ▶ light when text information does not fit with the range provided by "6".



# Rear Panel

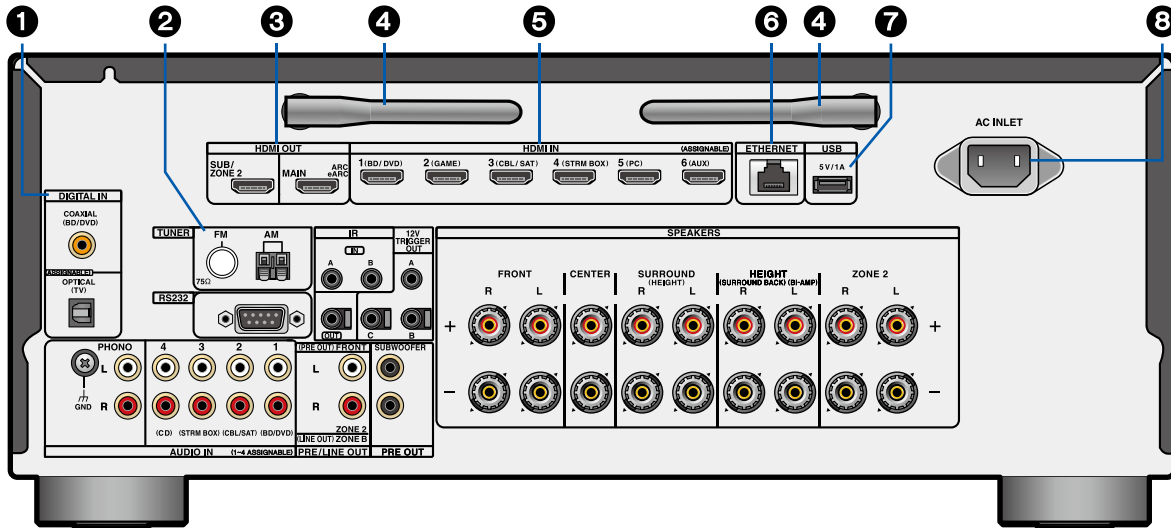

- HDMI IN jacks:** Transmit video signals and audio signals with an HDMI cable connected to an AV component.
- ETHERNET port:** Connect to the network with an Ethernet cable.
- USB port:** Connect a USB storage device to play music files (→p88). You can also supply power (5 V/1 A) to USB devices with a USB cable.
- AC INLET:** Connect the supplied power cord.

- DIGITAL IN OPTICAL/COAXIAL jacks:** Input TV or AV component digital audio signals with a digital optical cable or digital coaxial cable.
- TUNER AM/FM terminal:** Connect the supplied antennas.
- HDMI OUT jacks:** Transmit video signals and audio signals with an HDMI cable connected to a monitor such as a TV or projector.

- Wireless antenna:** Used for Wi-Fi connection or when using a BLUETOOTH enabled device. Adjust the angles according to the connection status.

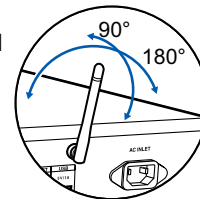

# Rear Panel

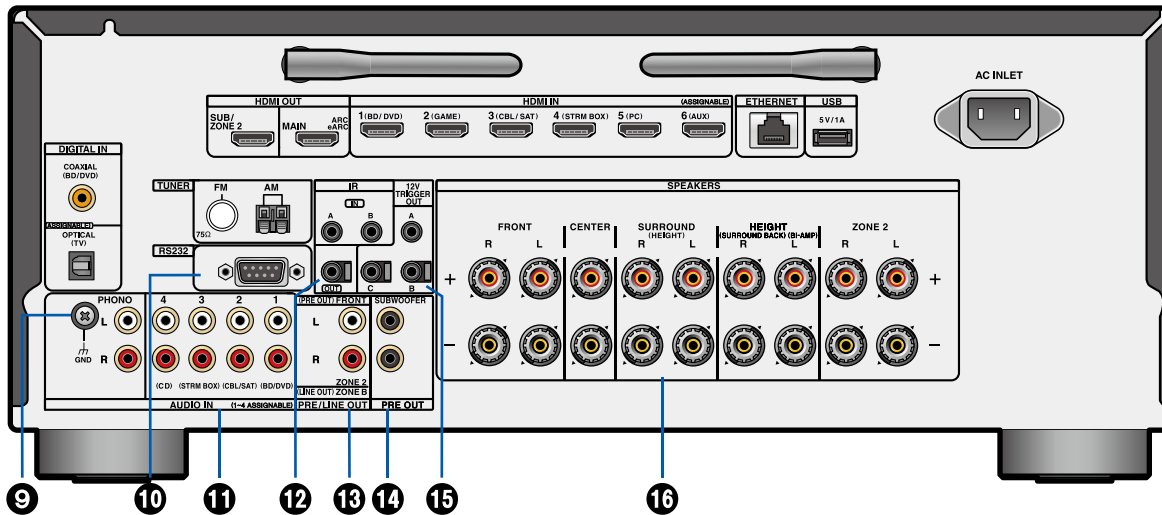

9. **GND terminal:** Connect the ground wire of the turntable.
10. **RS-232 port:** Connect a home control system equipped with an RS-232C port. For adopting a home control system, contact the specialized stores.
11. **AUDIO IN jacks:** Input AV component audio signals with an analog audio cable.
12. **IR IN A/B, IR OUT jacks:** Connect a remote control receiver unit. ( → [p56](#) )

13. **ZONE 2 PRE/LINE OUT jacks:** Output audio signals with an analog audio cable connected to an integrated amplifier in a separate room (ZONE 2).  
**ZONE B LINE OUT jacks:** Simultaneously output the same audio source as the speakers (ZONE A) connected to this unit by connecting this unit to wireless headphones, wireless speaker transmitter, etc., using an analog audio cable.

**PRE OUT FRONT jacks:** Connect to a power amplifier. ( → [p46](#) )

14. **SUBWOOFER PRE OUT jacks:** Connect a powered subwoofer with a subwoofer cable. Up to two powered subwoofers can be connected. The same signal is output from each SUBWOOFER PRE OUT jack.
15. **12V TRIGGER OUT A/B/C jack:** Connect a device equipped with a 12V trigger input jack to enable power link operation between the device and this unit. ( → [p57](#) )
16. **SPEAKERS terminals:** Connect speakers with speaker cables. (North American models support banana plugs. Use a plug 4 mm in diameter. Y plug connection is not supported.)



# Remote Controller

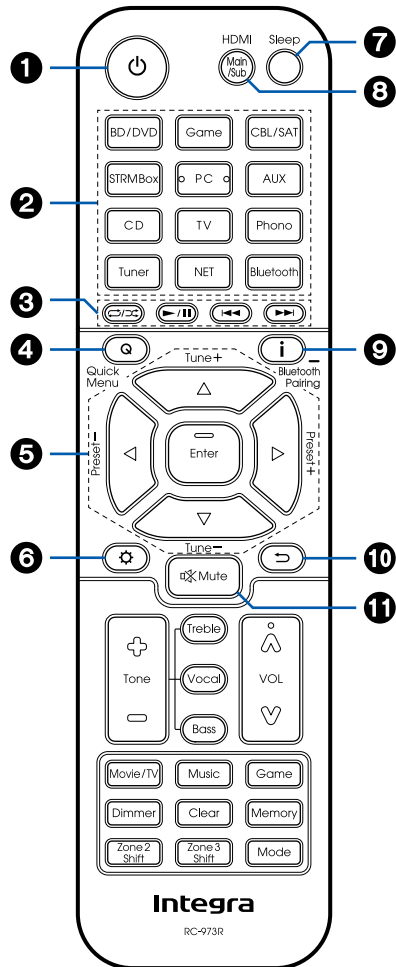

1. **On/Standby button**
2. **Input selector buttons:** Switches the input to be played.
3. **Play buttons:** Used for playback operations for the Music Server ( →p91) or USB device ( →p88). Also, switching to "CEC MODE" with "19. Mode button" allows you to operate an HDMI CEC function-enabled AV component. (Some devices may not be operated.)
4. **Q (Quick Menu) button:** Pressing this button during playback allows you to make settings such as "HDMI" and "Audio" quickly on the TV screen while playing. ( →p70)
5. **Cursor buttons and Enter button:** Select an item with the cursors, and press Enter to confirm your selection. Pressing ◀/▶ button allows you to switch the screen when a music folder list or file list is not displayed on one screen on the TV.
6. **Settings button:** Displays advanced setting items on the TV or the display to have a more enjoyable experience with this unit. ( →p97)
7. **Sleep button:** You can allow the unit to enter standby automatically when the specified time has elapsed. Select the time from "30 min", "60 min", "90 min" and "Off". When you do not want to turn the unit to standby automatically, select "Off". You can also set this by pressing Settings button and selecting "6. Hardware" - "Power Management" - "Sleep Timer" ( →p121) on the Setup menu.
8. **HDMI Main/Sub button:** Select the HDMI OUT jack to output video signals from "MAIN", "SUB", and "MAIN+SUB".
9. **i button:** Switches the information on the display and is used to operate RDS ( →p65). Also, when the "BLUETOOTH" input selector is

- selected, pressing and holding this button for 5 seconds or more will switch to the pairing mode.
10. **Return button:** Returns the display to the previous state while setting.
11. **Mute button:** Temporarily mutes audio. Press the button again to cancel muting.



# Remote Controller

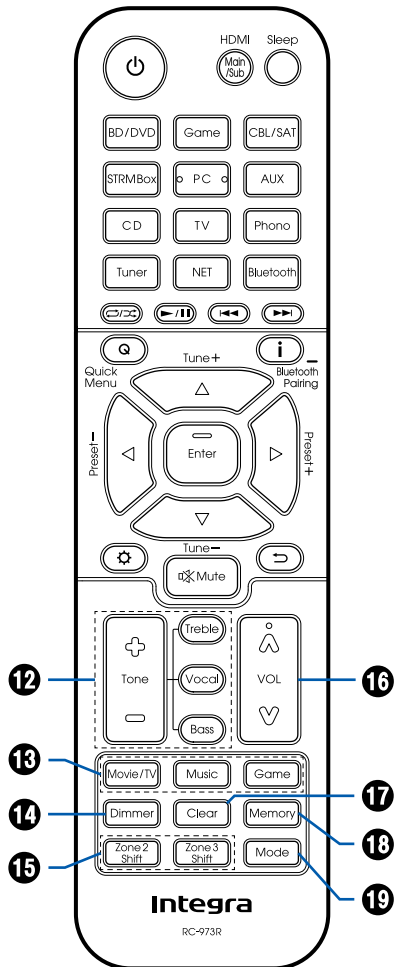

12. **Tone buttons:** Adjusts the sound quality. Press "Treble", "Bass", or "Vocal" to select what you want to adjust, then adjust with + and -.

**Treble/Bass button:** You can adjust the sound quality of the front speakers.

1. Press Treble or Bass to select the content to adjust.

Treble: Enhances or moderates the high-tone range of the front speakers.

Bass: Enhances or moderates the low-tone range of the front speakers.

2. Press + or - to adjust.

**Vocal button:** Emphasizes movie dialogues and music vocals to listen to them more easily. It is effective to movie lines in particular. Also, it exerts the effect even if the center speaker is not used. Select a desired level from "1" (low) to "5" (high).

1. Press Vocal.

2. Press + or - to adjust.

- Depending on the input source or listening mode setting, selection is not possible, or the desired effect may not be achieved.

13. **Listening Mode buttons:** Selects a listening mode (→[p68](#), [p148](#)).

14. **Dimmer button:** Switches the brightness of the display with three levels. It cannot be turned off completely.

15. **Zone 2 Shift button:** Used to control the multi-zone function (→[p84](#)). (The Zone 3 Shift button cannot be used with this unit.)

16. **VOLUME buttons**

17. **Clear button:** Deletes all characters you have entered when entering text on the TV screen.

18. **Memory button:** Used to register AM/FM radio stations. (→[p67](#))

19. **Mode button:** Switches between automatic tuning and manual tuning for AM/FM stations (→[p64](#)). Also, when an HDMI CEC function-enabled AV component is connected to this unit, you can switch "3. Play buttons" between "CEC MODE" and "RCV MODE" (normal mode).





# Inputting Characters

You can input characters or symbols on the keyboard displayed on the TV screen such as when inputting a password for Wi-Fi Setup ( →p116) or naming a preset radio station ( →p111).

1. Select a character or symbol with the cursors ▲ / ▼ / ◀ / ▶ on the remote controller and press the Enter button.
2. When saving characters after input, select "OK" and press the Enter button.

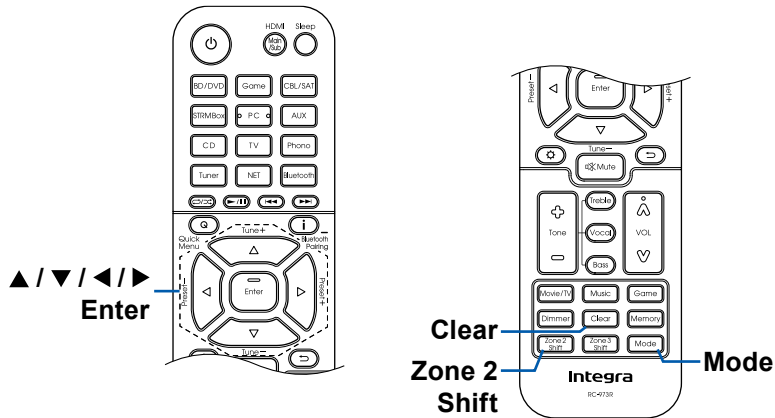
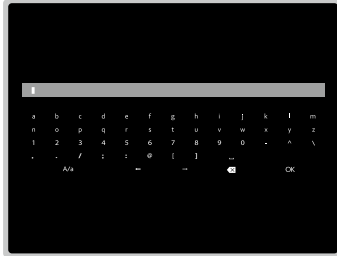

- Select "A/a" to switch between upper and lower cases. (Can also be switched with the Mode button on the remote controller.)
- To enter a space, select "␣".
- To delete a character on the left of the cursor, select "⌫".
- To delete all the input characters, press the Clear button on the remote control.
- On the ZONE 2 playback screen, operate the remote controller while pressing and holding the Zone 2 Shift button. To delete all the input characters, only press the Clear button without pressing the Zone 2 Shift button.



This unit can be used in different ways, depending on the layout of the speakers you are installing. Select the speaker layout that suits the installation environment, then confirm the methods for installation and connection.

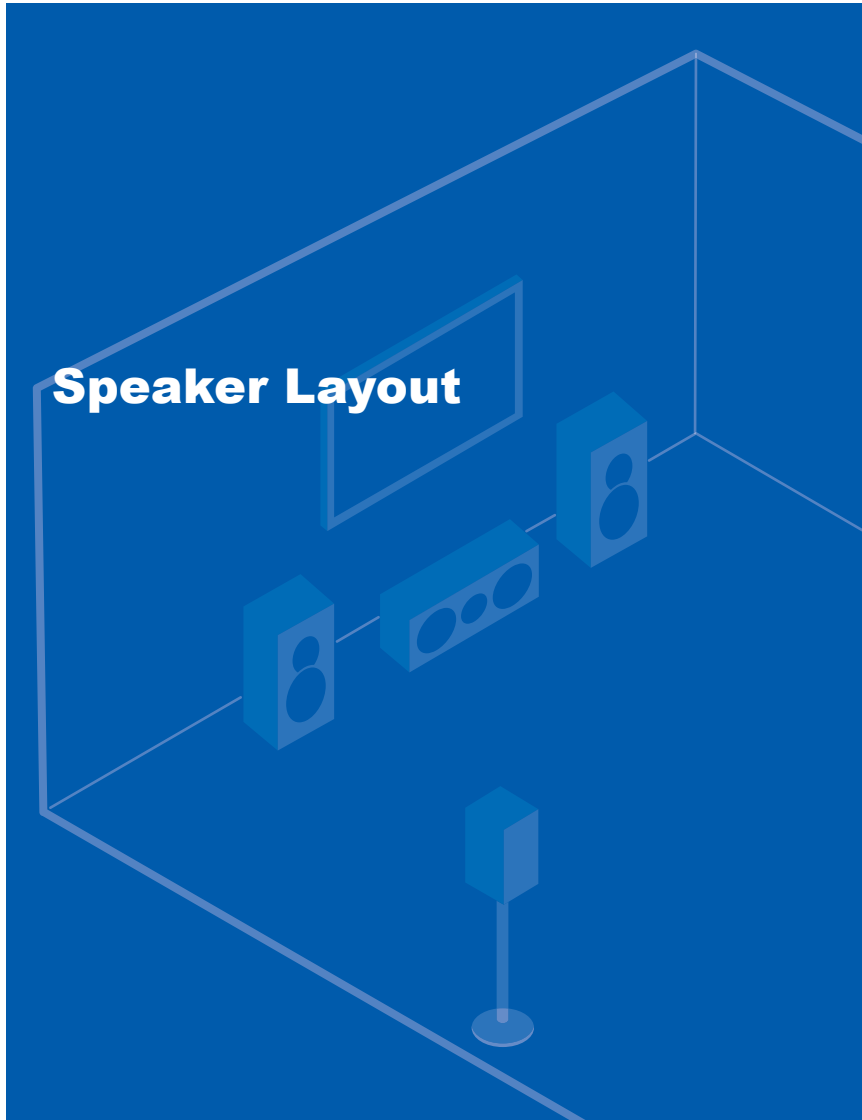

- Speaker Layout** ( →[p20](#))
- Speaker Installation** ( →[p25](#))
- Speaker Connections** ( →[p30](#))
- Speaker Combinations** ( →[p158](#))



- 3.1ch
- 5.1ch
- 7.1ch
- 3.1.2ch
- 5.1.2ch

## The listening room and the speaker layout

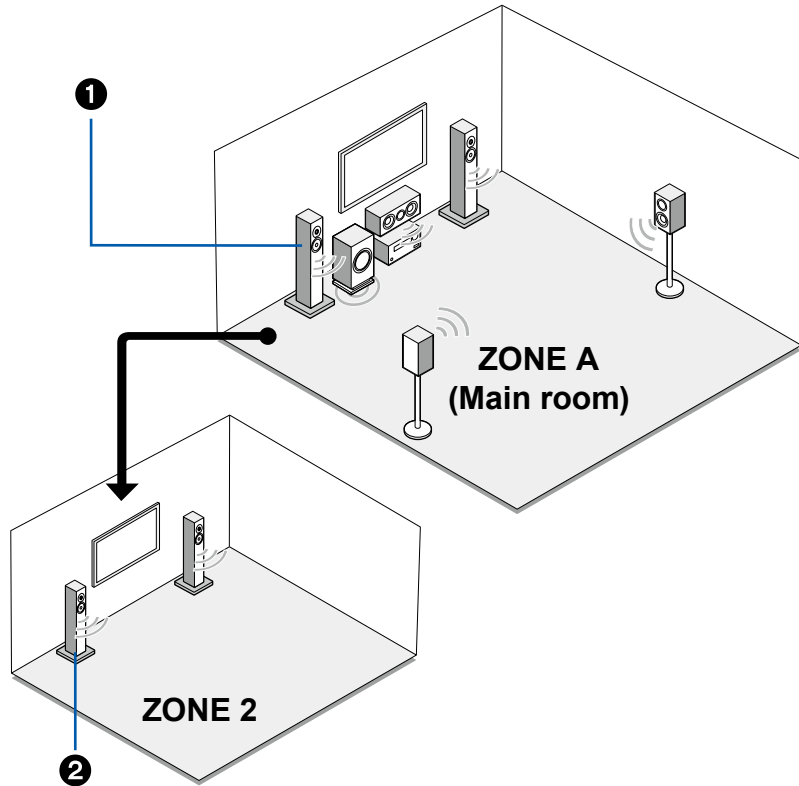

### 1. ZONE A Speakers

The speaker system set up in the main room (where this unit is located).

### 2. ZONE 2 Speakers

The 2 ch speaker system set up in a separate room (ZONE 2). This enables you to play the same source in the main room and the separate at the same time, or to play separate sources.



3.1ch

5.1ch

7.1ch

3.1.2ch

5.1.2ch

## 3.1 Channel System

A 3.1 Channel System that combines front speakers with a center speaker and a subwoofer.

Basic system ( →p26)

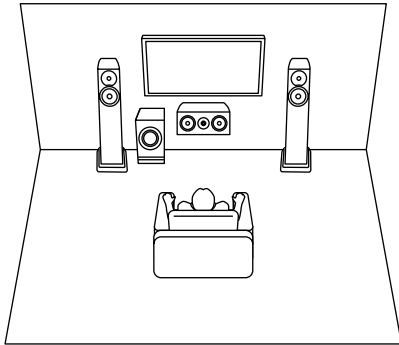

3.1 ch + ZONE 2 ( →p26)

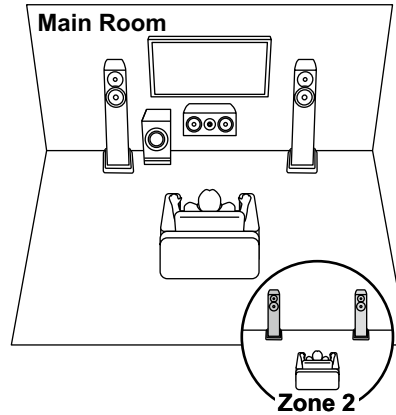

3.1 ch (Bi-Amping (Front)) ( →p26)

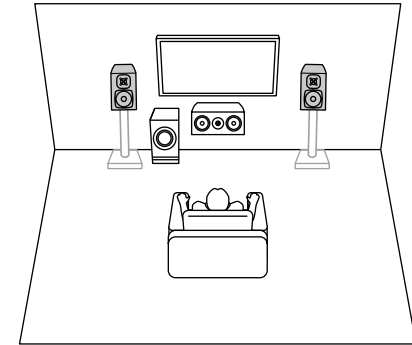

3.1ch

5.1ch

7.1ch

3.1.2ch

5.1.2ch

## 5.1 Channel System This is a basic 5.1 Channel System.

Basic system ( →p26)

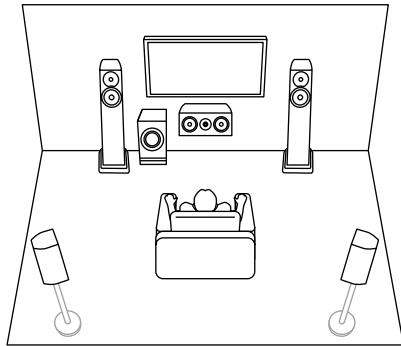

5.1 ch + ZONE 2 ( →p26)

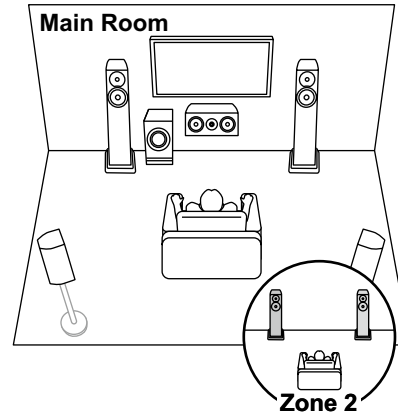

5.1 ch (Bi-Amping (Front)) ( →p26)

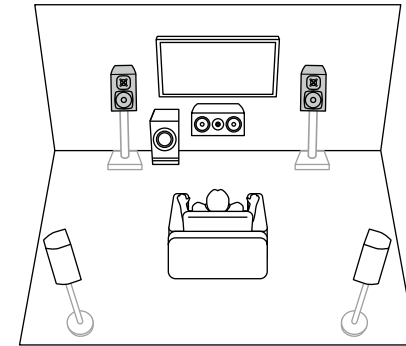

3.1ch

5.1ch

7.1ch

3.1.2ch

5.1.2ch

## 7.1 Channel System

This is a 7.1 Channel System that consists of the basic 5.1 Channel System and added surround back speakers.

Basic system ( →p27)

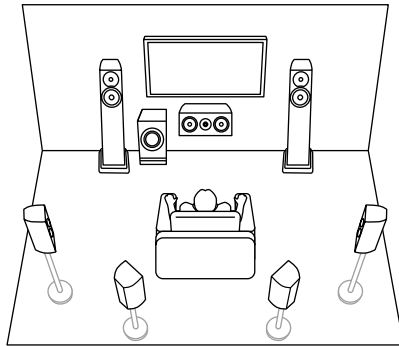

7.1 ch + ZONE 2 ( →p27)

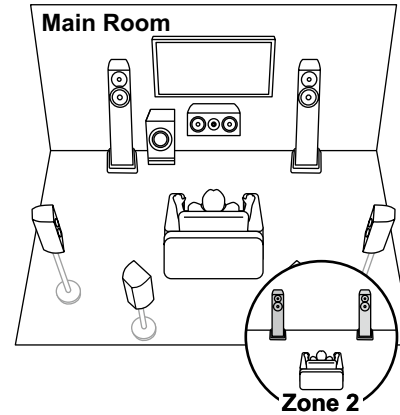

3.1ch

5.1ch

7.1ch

3.1.2ch

5.1.2ch



## 3.1.2 Channel System

A Speaker System that is a 3.1 Channel System with one set of height speakers added.

3.1.2 ch (Front High or Rear High) (→p28)

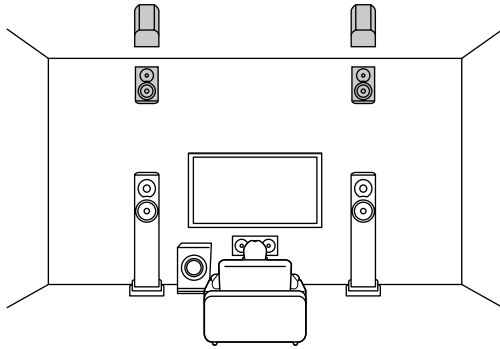

3.1.2 ch (Top Front or Top Middle or Top Rear) (→p28)

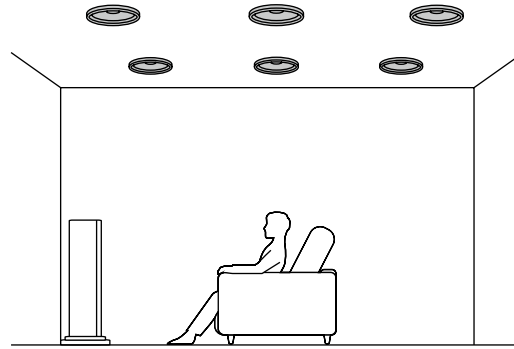

3.1.2 ch (Dolby Enabled Speakers (Front)) (→p28)

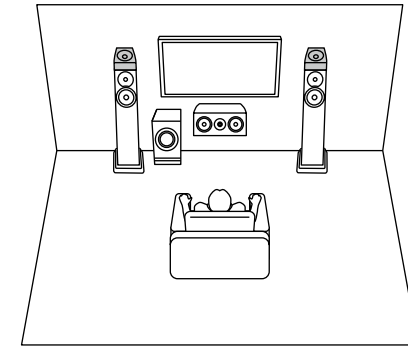

3.1.2 ch + ZONE 2 (→p28)

### Main Room

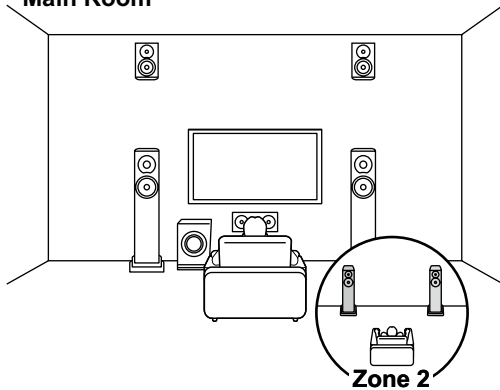

3.1.2 ch (Bi-Amping (Front)) (→p28)

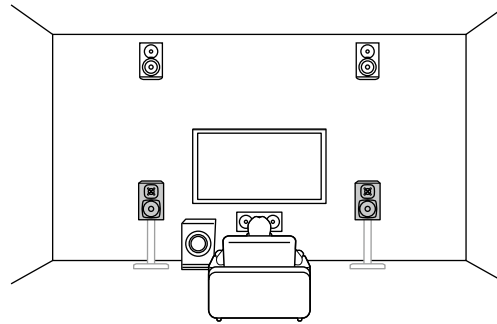

3.1ch

5.1ch

7.1ch

3.1.2ch

5.1.2ch

## 5.1.2 Channel System

A Speaker System that is a 5.1 Channel System with one set of height speakers added.

5.1.2 ch (Front High or Rear High) (→p29)

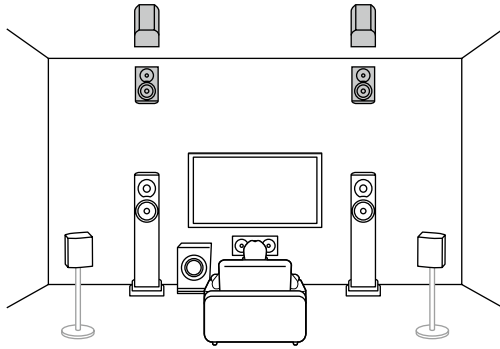

5.1.2 ch (Top Front or Top Middle or Top Rear) (→p29)

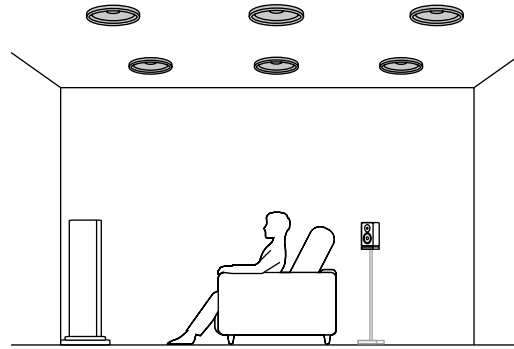

5.1.2 ch (Dolby Enabled Speakers (Front or Surround)) (→p29)

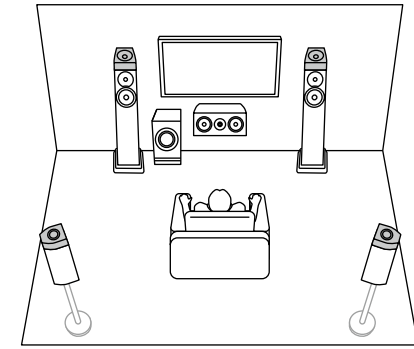

5.1.2 ch + ZONE 2 (→p29)

### Main Room

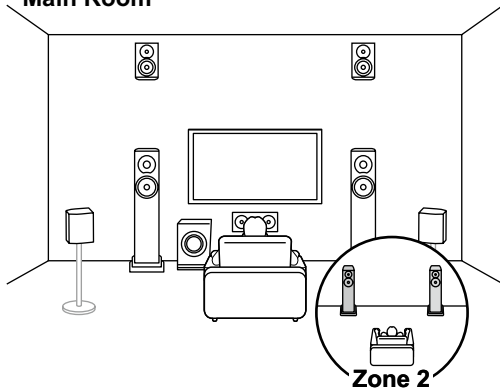

3.1ch

5.1ch

7.1ch

3.1.2ch

5.1.2ch



How the speakers are set up depends on the size and shape of the room, so here we introduce just a basic layout example.

The alphabetic symbols used in this chapter represent the following speakers:

|            |                                      |
|------------|--------------------------------------|
| <b>FL</b>  | Front speaker Left                   |
| <b>FR</b>  | Front speaker Right                  |
| <b>C</b>   | Center speaker                       |
| <b>SL</b>  | Surround speaker Left                |
| <b>SR</b>  | Surround speaker Right               |
| <b>SBL</b> | Surround Back speaker Left           |
| <b>SBR</b> | Surround Back speaker Right          |
| <b>FHL</b> | Front High speaker Left              |
| <b>FHR</b> | Front High speaker Right             |
| <b>RHL</b> | Rear High speaker Left               |
| <b>RHR</b> | Rear High speaker Right              |
| <b>TFL</b> | Top Front speaker Left               |
| <b>TFR</b> | Top Front speaker Right              |
| <b>TML</b> | Top Middle speaker Left              |
| <b>TMR</b> | Top Middle speaker Right             |
| <b>TRL</b> | Top Rear speaker Left                |
| <b>TRR</b> | Top Rear speaker Right               |
| <b>DFL</b> | Dolby enabled speaker Front Left     |
| <b>DFR</b> | Dolby enabled speaker Front Right    |
| <b>DSL</b> | Dolby enabled speaker Surround Left  |
| <b>DSR</b> | Dolby enabled speaker Surround Right |

3.1ch

5.1ch

7.1ch

3.1.2ch

5.1.2ch

## Speaker Installation



## 3.1 Channel System

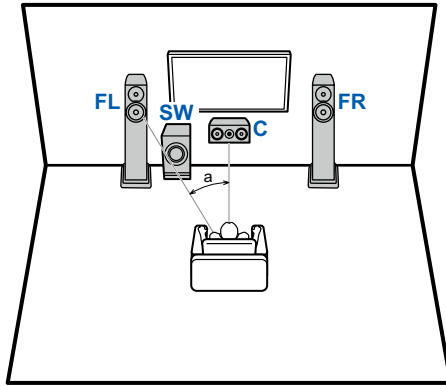

a: 22° to 30°

- FL, FR** Place the Left and Right Front Speakers to match ear height. The center speaker should be set up facing the listening position at an angle.
- C**
- SW** Place the powered subwoofer between the center speaker and a front speaker.

## 5.1 Channel System

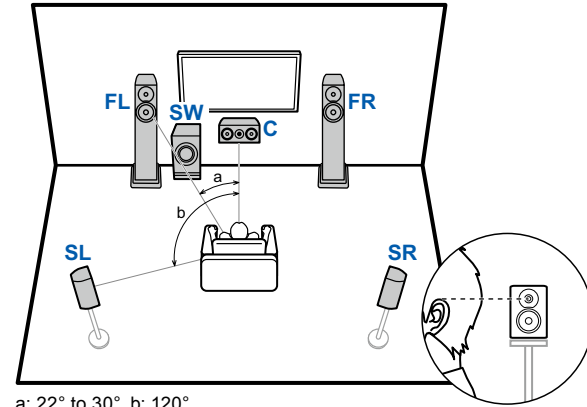

a: 22° to 30°, b: 120°

- FL, FR** Place the Left and Right Front Speakers to match ear height. The center speaker should be set up facing the listening position at an angle.
- C**
- SW** Place the powered subwoofer between the center speaker and a front speaker.
- SL, SR** Place the Left and Right Surround Speakers to be just above ear height.

- 3.1 ch connection ( → [p33](#) )
- 3.1 ch + ZONE 2 connection ( → [p34](#) )
- 3.1 ch (Bi-Amping (Front)) connection ( → [p35](#) )

- 5.1 ch connection ( → [p36](#) )
- 5.1 ch + ZONE 2 connection ( → [p37](#) )
- 5.1 ch (Bi-Amping (Front)) connection ( → [p38](#) )



3.1ch

5.1ch

7.1ch

3.1.2ch

5.1.2ch

## 7.1 Channel System

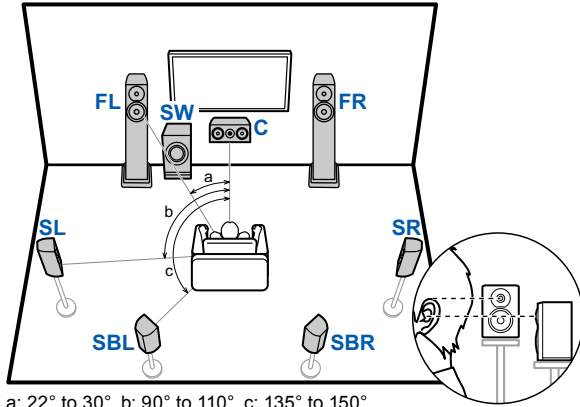

a: 22° to 30°, b: 90° to 110°, c: 135° to 150°

- FL, FR** Place the Left and Right Front Speakers to match ear height.
- C** The center speaker should be set up facing the listening position at an angle.
- SW** Place the powered subwoofer between the center speaker and a front speaker.
- SL, SR** Place the Left and Right Surround Speakers to be just above ear height.
- SBL, SBR** Place the Left and Right Surround Back Speakers at ear height.
- If surround back speakers are installed, be sure to install surround speakers as well.

7.1 ch connection ( →p39)

7.1 ch + ZONE 2 connection ( →p40)



3.1ch

5.1ch

7.1ch

3.1.2ch

5.1.2ch

## 3.1.2 Channel System

### High Speakers

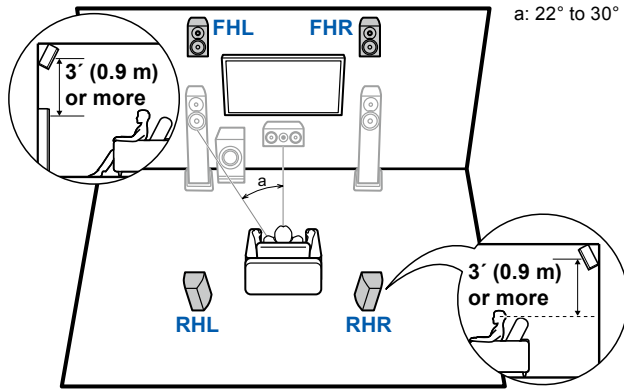

- FHL, FHR** Place the front high speakers directly above the front speakers, angled to face the listening position.
- RHL, RHR** Place the rear high speakers so the lateral distance matches the front speakers, angled to face the listening position.

- 3.1.2 ch connection ( →[p41](#))
- 3.1.2 ch + ZONE 2 connection ( →[p42](#))
- 3.1.2 ch (Bi-Amping (Front)) connection ( →[p43](#))

### Top Speakers

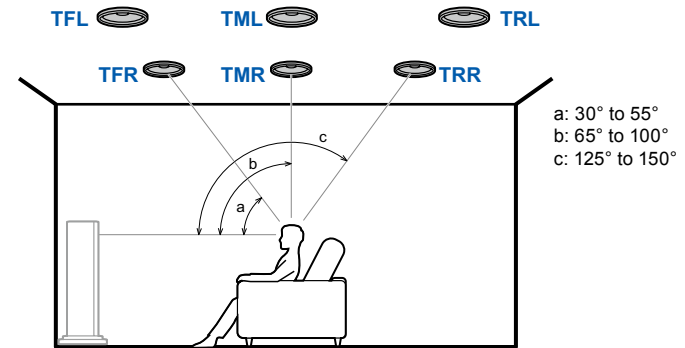

- TFL, TFR** Fit top front speakers on the ceiling in front of the listening position.
- TML, TMR** Fit top middle speakers on the ceiling directly above the listening position.
- TRL, TRR** Fit top rear speakers on the ceiling behind the listening position.
- Match the lateral distance of the top speakers to the front speakers.

### Dolby Enabled Speakers

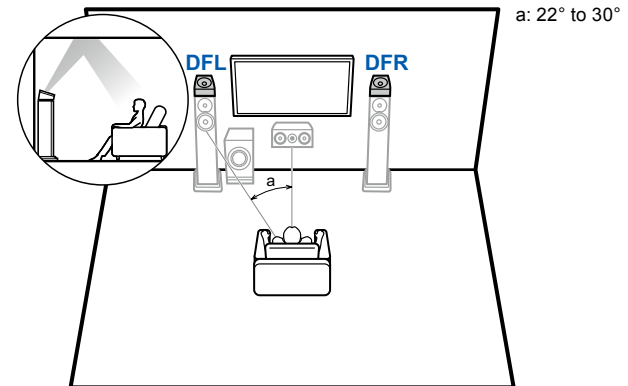

- DFL, DFR** The Dolby enabled speakers (front) are installed on top of the front speakers.

3.1ch

5.1ch

7.1ch

3.1.2ch

5.1.2ch



## 5.1.2 Channel System

### High Speakers

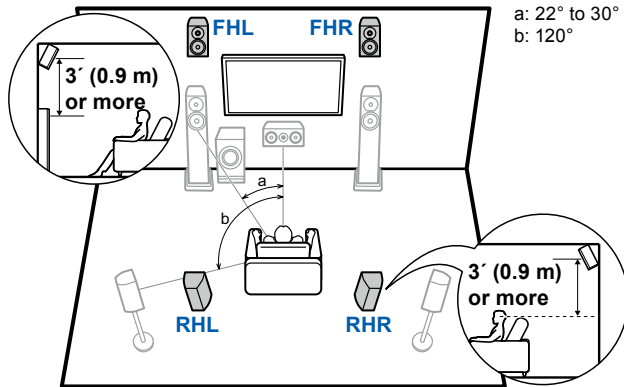

**FHL, FHR** Place the front high speakers directly above the front speakers, angled to face the listening position.

**RHL, RHR** Place the rear high speakers so the lateral distance matches the front speakers, angled to face the listening position.

### Top Speakers

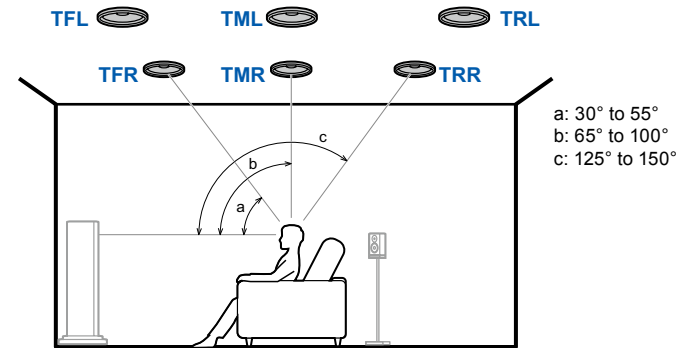

**TFL, TFR** Fit top front speakers on the ceiling in front of the listening position.

**TML, TMR** Fit top middle speakers on the ceiling directly above the listening position.

**TRL, TRR** Fit top rear speakers on the ceiling behind the listening position.

- Match the lateral distance of the top speakers to the front speakers.

### Dolby Enabled Speakers

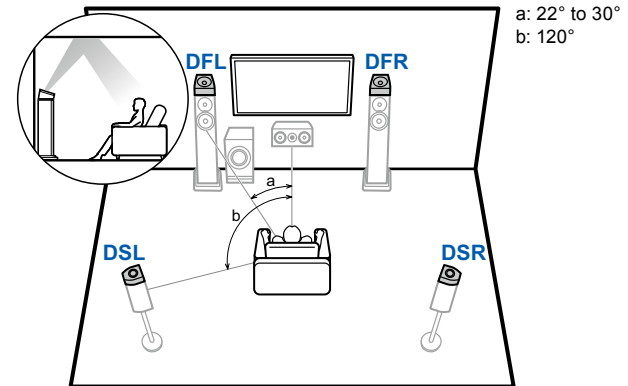

**DFL, DFR** The Dolby enabled speakers (front) are installed on top of the front speakers.

**DSL, DSR** The Dolby enabled speakers (surround) are installed on top of the surround speakers.

5.1.2 ch connection ( →p44)

5.1.2 ch + ZONE 2 connection ( →p45)



- 3.1ch
- 5.1ch
- 7.1ch
- 3.1.2ch
- 5.1.2ch

**(Before starting the procedure)  
Speaker Connections and "Speaker Impedance"  
Settings**

31

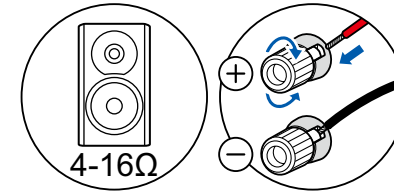

|                             |                   |
|-----------------------------|-------------------|
| <b>3.1 Channel System</b>   | <b>33, 34, 35</b> |
| <b>5.1 Channel System</b>   | <b>36, 37, 38</b> |
| <b>7.1 Channel System</b>   | <b>39, 40</b>     |
| <b>3.1.2 Channel System</b> | <b>41, 42, 43</b> |
| <b>5.1.2 Channel System</b> | <b>44, 45</b>     |

## Speaker Connections



- 3.1ch
- 5.1ch
- 7.1ch
- 3.1.2ch
- 5.1.2ch

# Speaker Connections and "Speaker Impedance" Settings

## Connections

### ■ (Note) Speaker Impedance

Connect speakers with an impedance of 4 Ω to 16 Ω. If any of the speakers to be connected has an impedance of 4 Ω or more and less than 6 Ω, set "Speaker Impedance" to "4ohms" for "Speaker Setup" in the Initial Setup section ( →p129). When setting "Speaker Impedance" from the Setup menu, press ⚙ on the remote controller, and set "2. Speaker" - "Configuration" - "Speaker Impedance" ( →p104) to "4ohms".

### ■ Connect the Speaker Cables

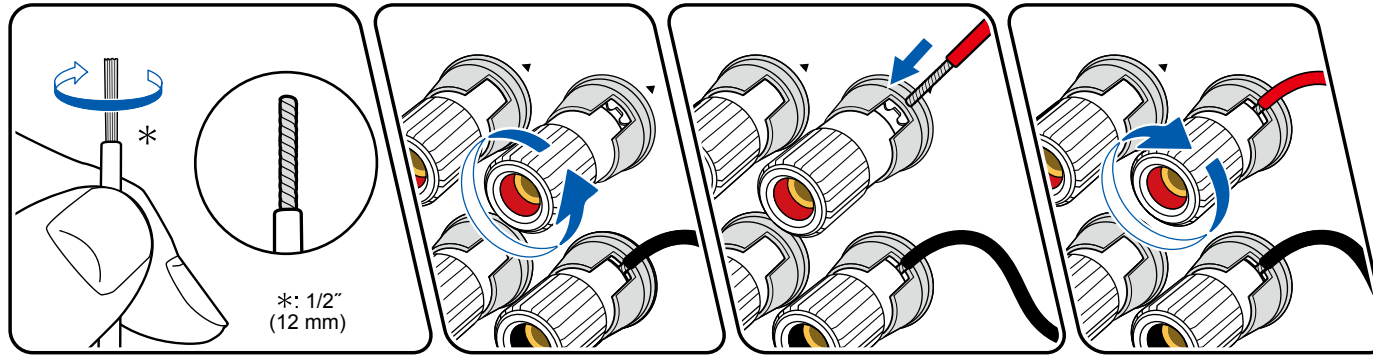

Make correct connection between the unit's jacks and speaker's jacks (+ side to + side, and - side to - side) for each channel. If the connection is wrong, a bass sound will not be reproduced properly due to reverse phase. Twist the wires exposed from the tip of the speaker cable so that the wires do not stick out of the speaker terminal when connecting. If the exposed wires touch the rear panel, or the + side and - side wires touch each other, a malfunction may occur.

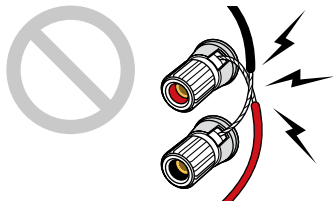

- 3.1ch
- 5.1ch
- 7.1ch
- 3.1.2ch
- 5.1.2ch



## ■ Connect the Subwoofer

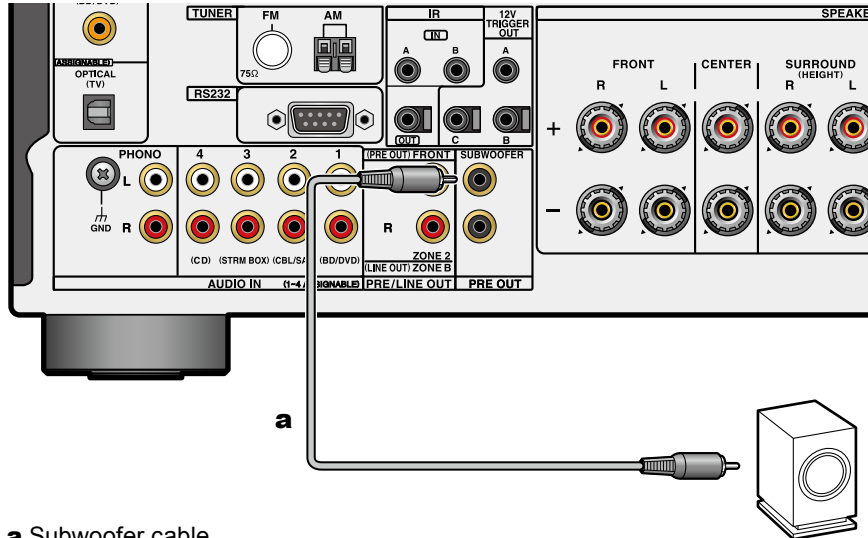

### **a** Subwoofer cable

Connect a powered subwoofer with this unit using a subwoofer cable. Up to two powered subwoofers can be connected. The same signal is output from each SUBWOOFER PRE OUT jack.

- 3.1ch
- 5.1ch
- 7.1ch
- 3.1.2ch
- 5.1.2ch





## 3.1 Channel System

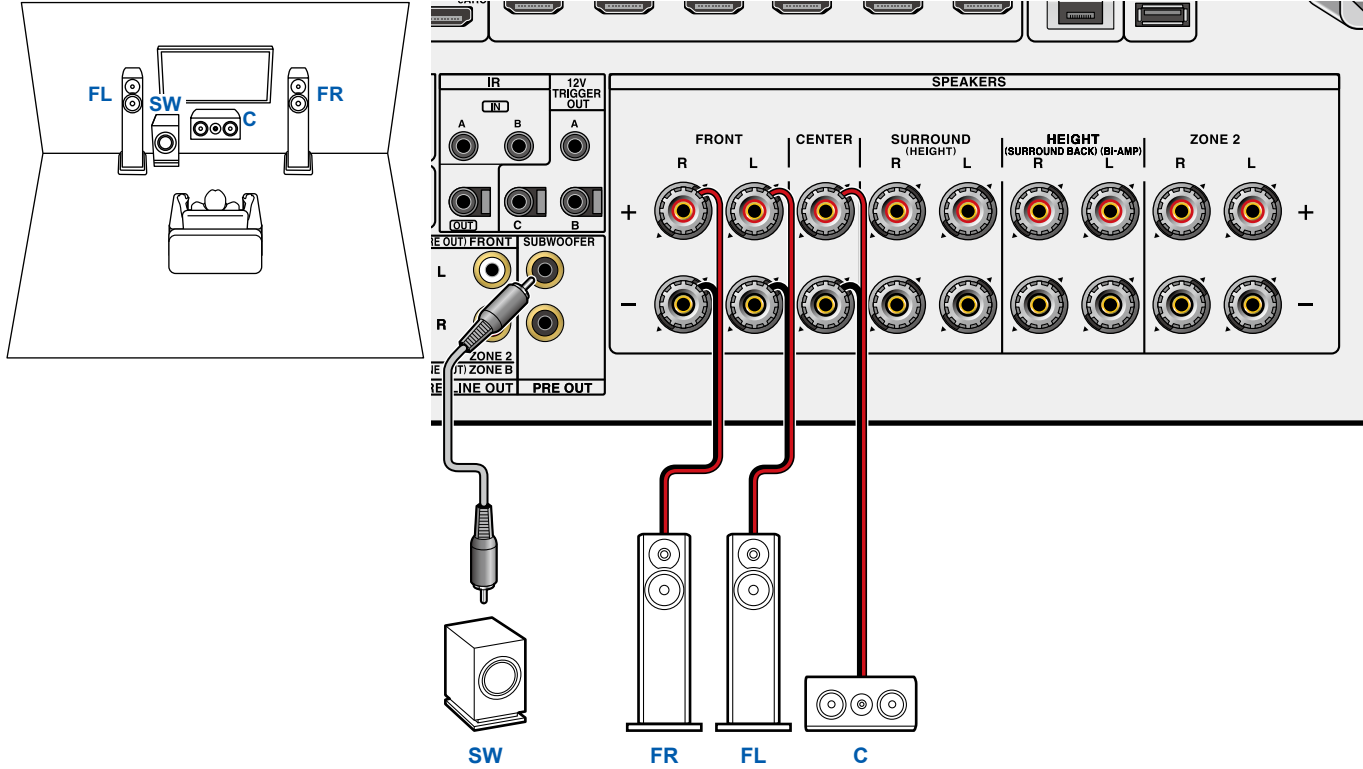

- 3.1ch
- 5.1ch
- 7.1ch
- 3.1.2ch
- 5.1.2ch



## 3.1 Channel System + ZONE SPEAKER

MAIN ROOM

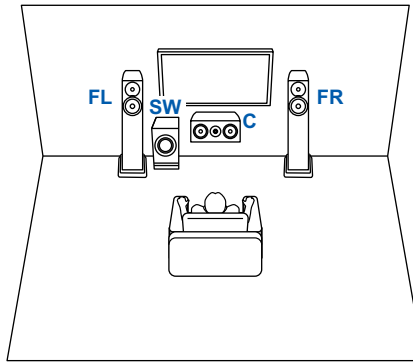

ZONE 2

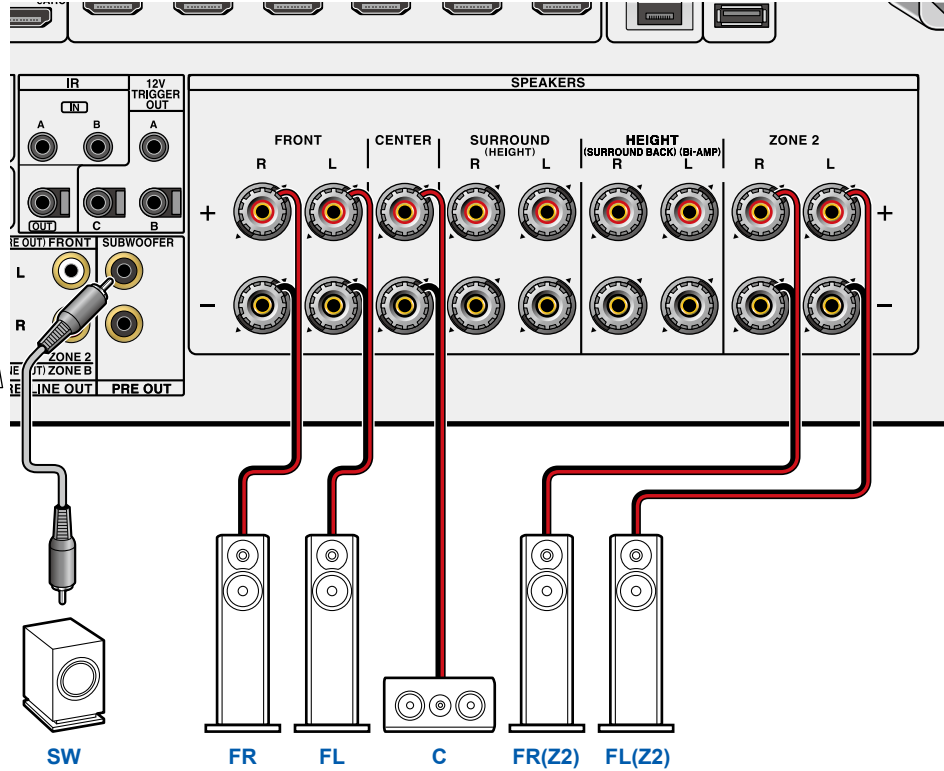
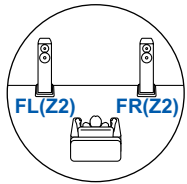

- 3.1ch
- 5.1ch
- 7.1ch
- 3.1.2ch
- 5.1.2ch



## 3.1 Channel System (Bi-Amping the Speakers)

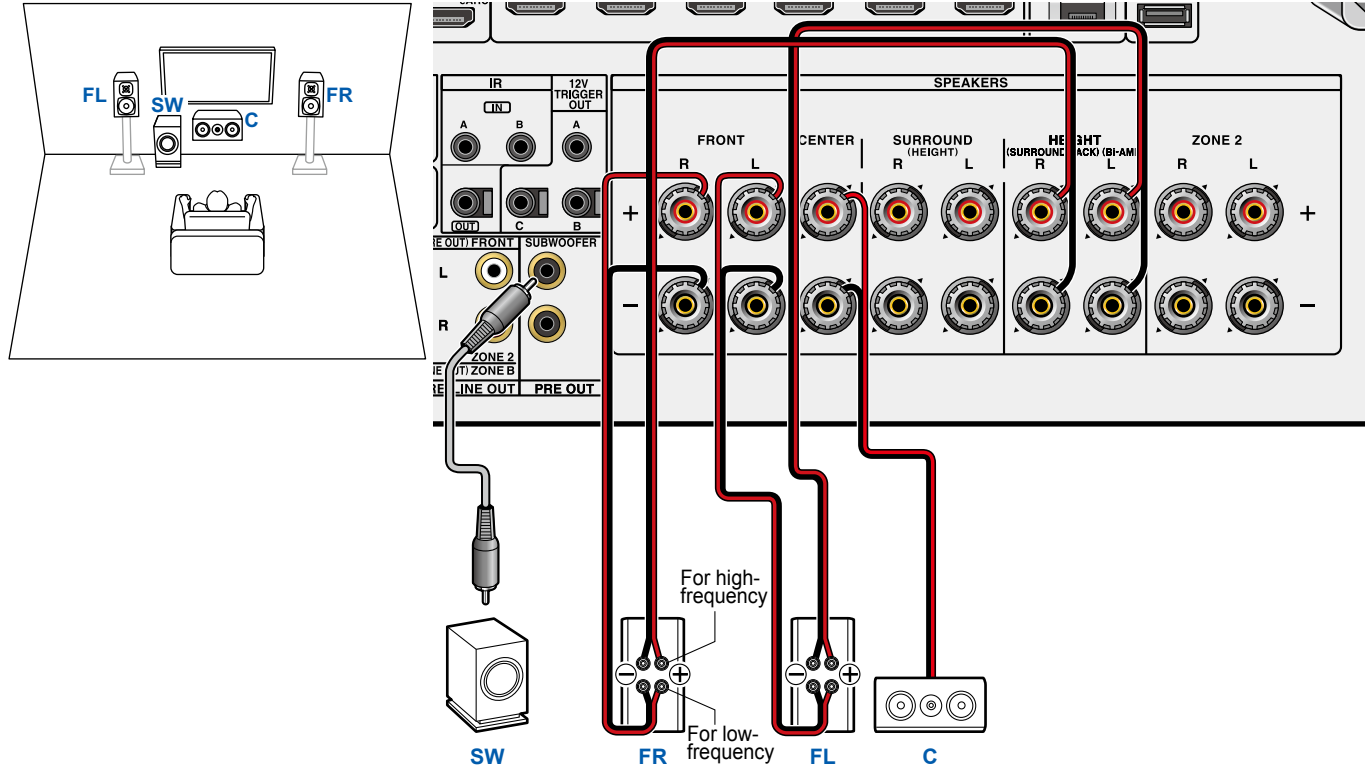

Be sure to remove the jumper bar connecting between the woofer jacks and tweeter jacks of the Bi-Amping supported speakers. Refer to the instruction manual of your speakers as well.

3.1ch

5.1ch

7.1ch

3.1.2ch

5.1.2ch



## 5.1 Channel System

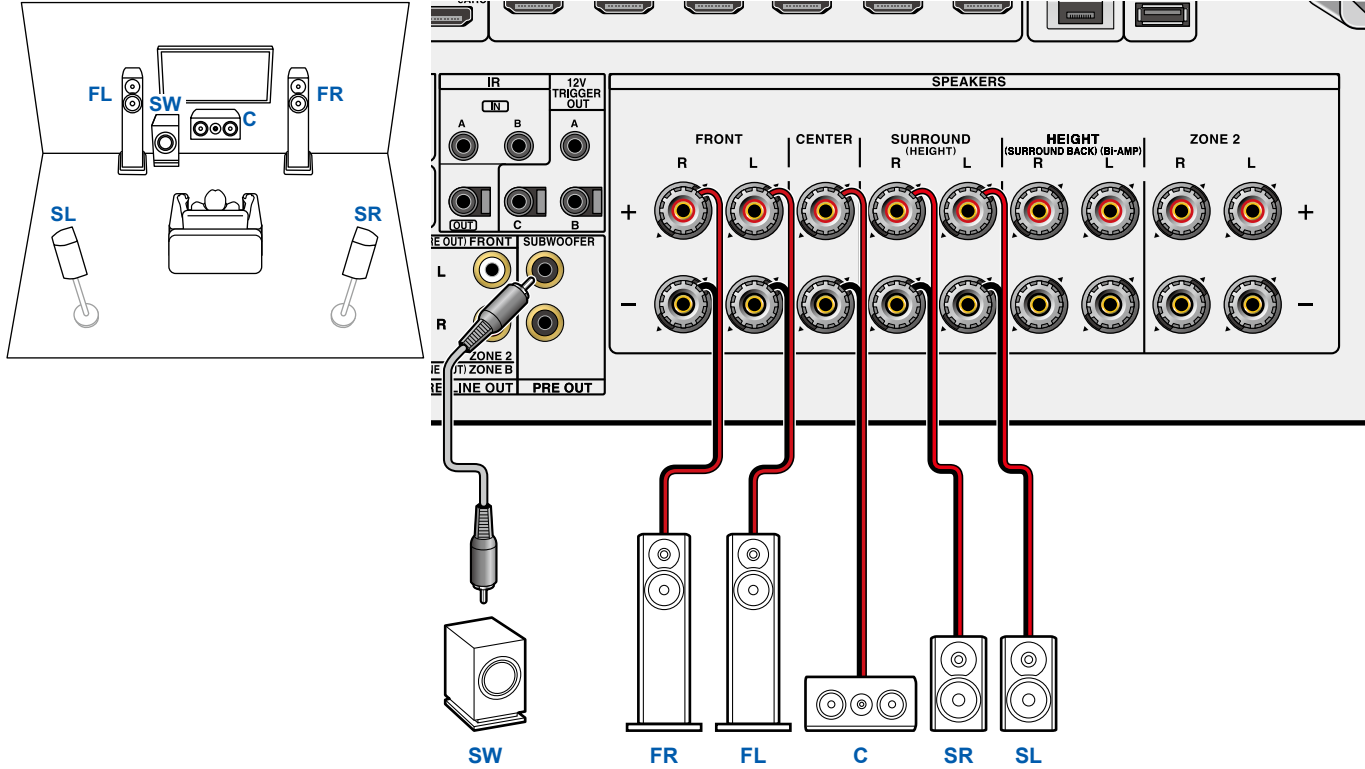

- 3.1ch
- 5.1ch**
- 7.1ch
- 3.1.2ch
- 5.1.2ch



## 5.1 Channel System + ZONE SPEAKER

MAIN ROOM

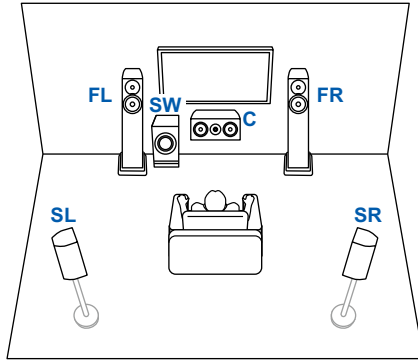

ZONE 2

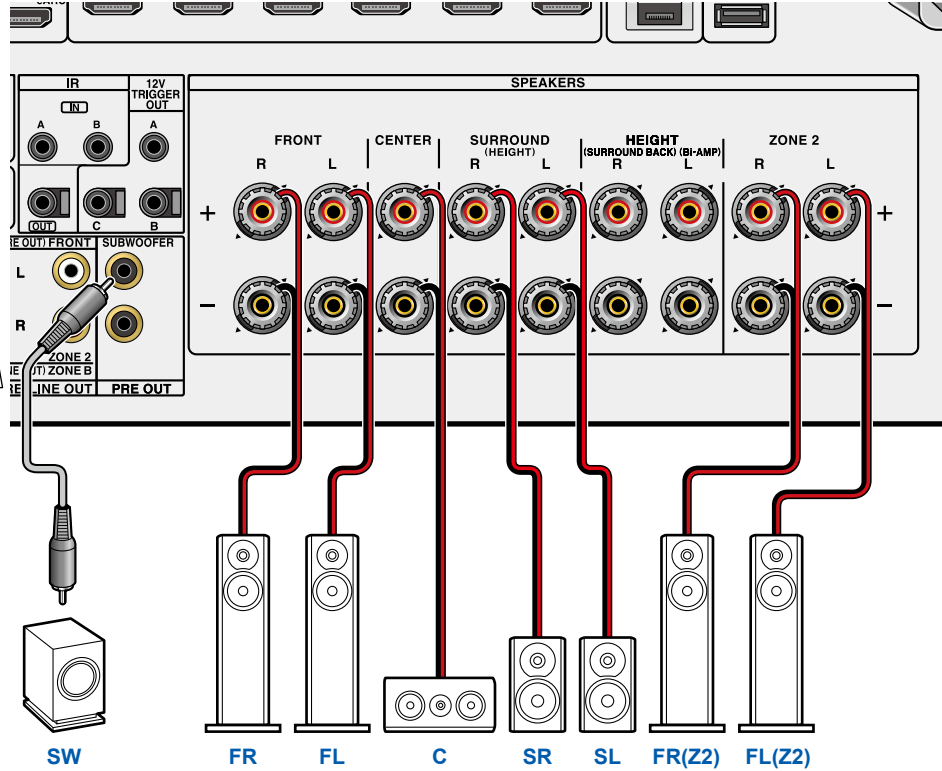
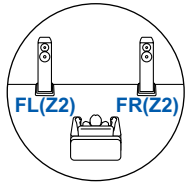

- 3.1ch
- 5.1ch
- 7.1ch
- 3.1.2ch
- 5.1.2ch



## 5.1 Channel System (Bi-Amping the Speakers)

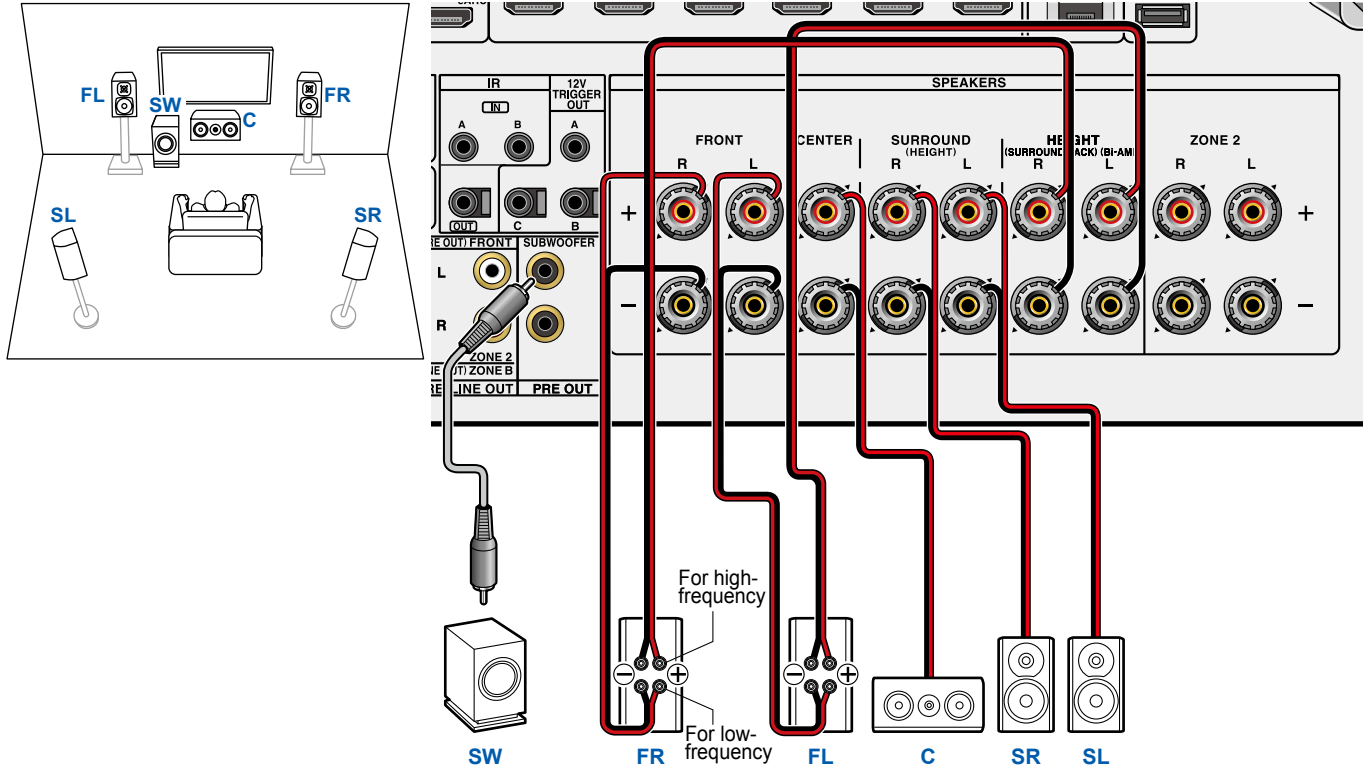

Be sure to remove the jumper bar connecting between the woofer jacks and tweeter jacks of the Bi-Amping supported speakers. Refer to the instruction manual of your speakers as well.

3.1ch

5.1ch

7.1ch

3.1.2ch

5.1.2ch



## 7.1 Channel System

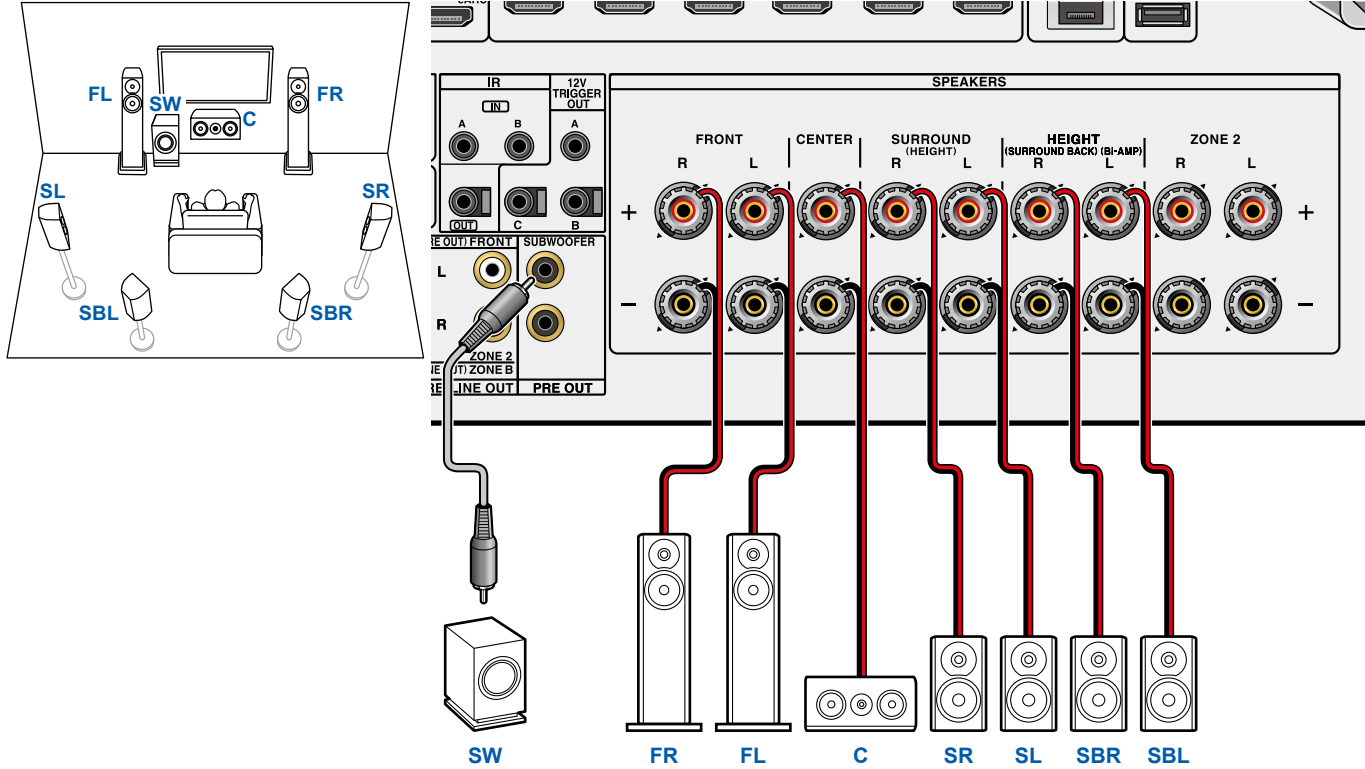

- 3.1ch
- 5.1ch
- 7.1ch
- 3.1.2ch
- 5.1.2ch



## 7.1 Channel System + ZONE SPEAKER

### MAIN ROOM

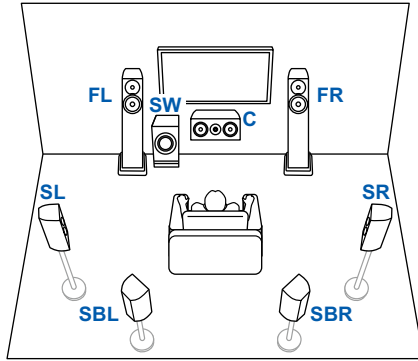

### ZONE 2

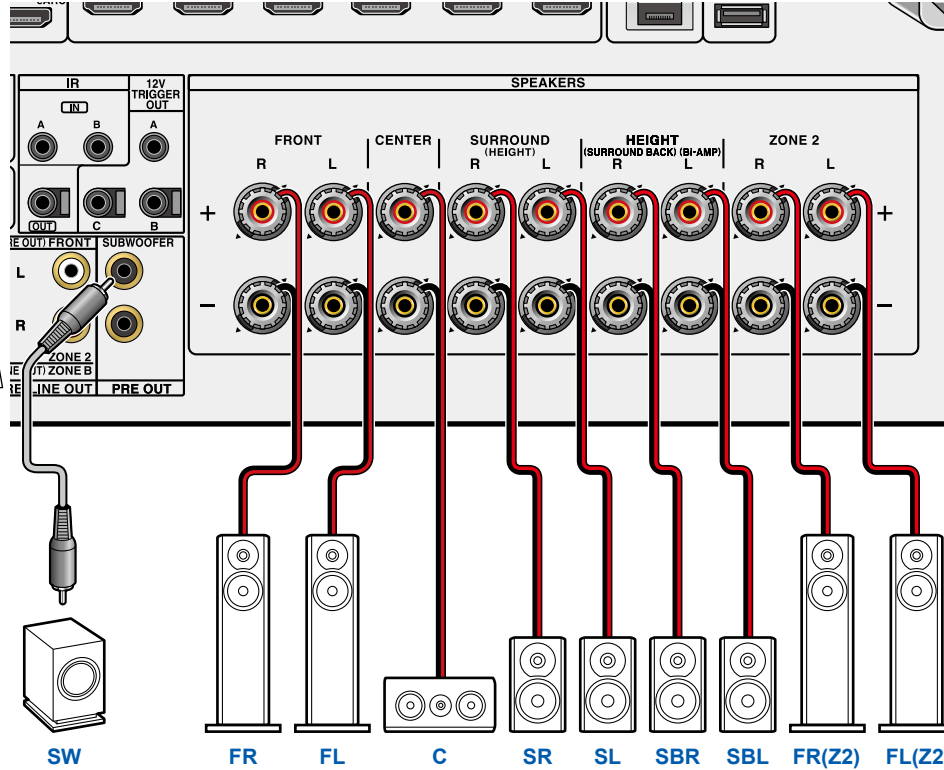
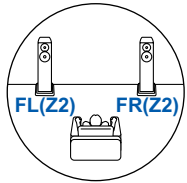

While ZONE 2 playback is being performed, surround back speakers installed in the main room cannot play audio.

- 3.1ch
- 5.1ch
- 7.1ch
- 3.1.2ch
- 5.1.2ch





## 3.1.2 Channel System

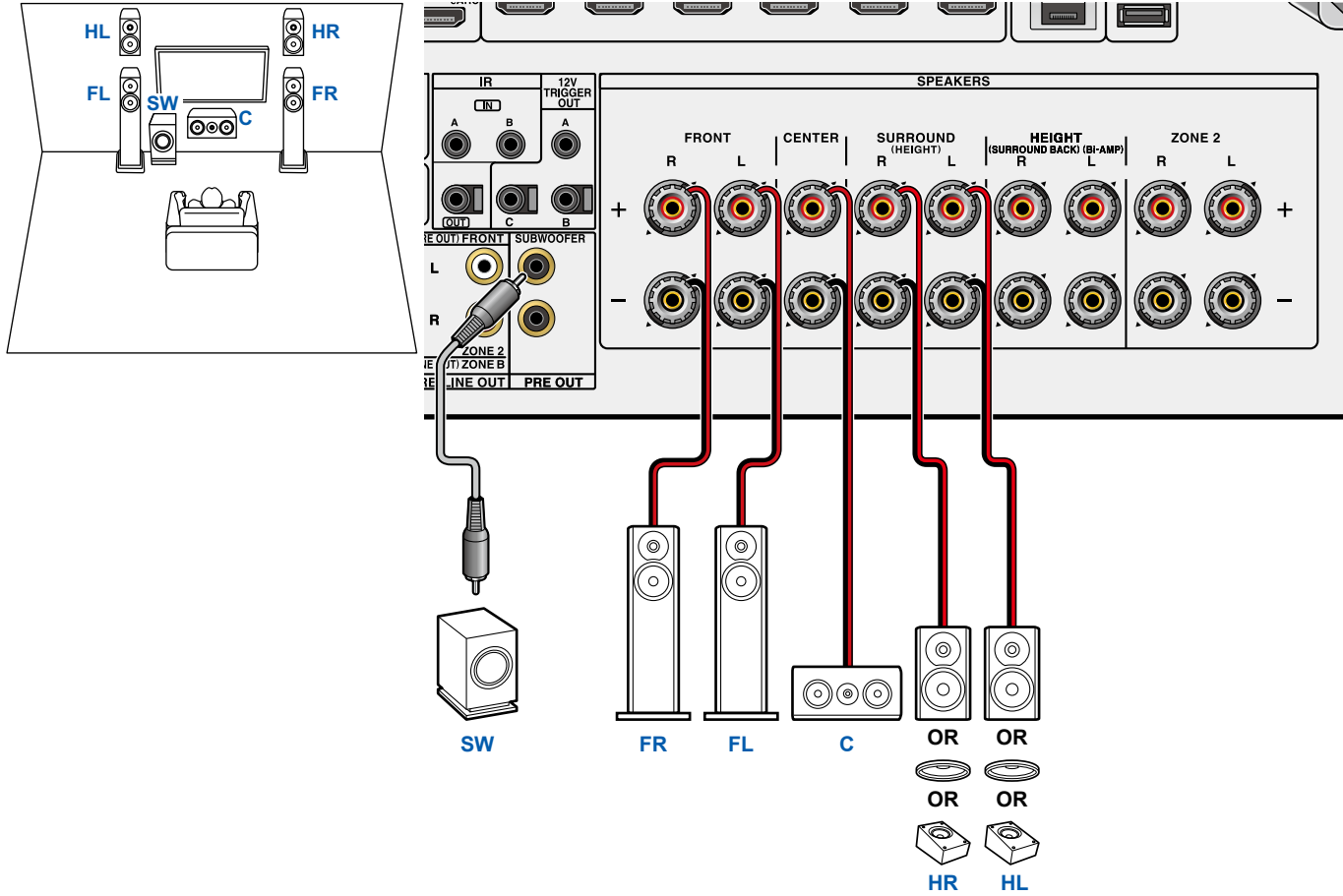

- 3.1ch
- 5.1ch
- 7.1ch
- 3.1.2ch**
- 5.1.2ch



## 3.1.2 Channel System + ZONE SPEAKER

### MAIN ROOM

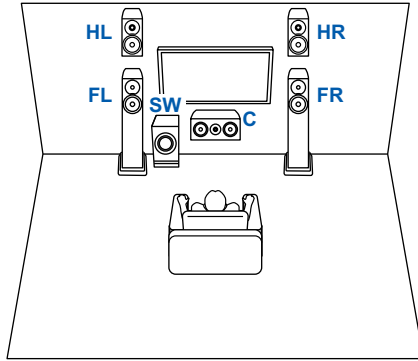

### ZONE 2

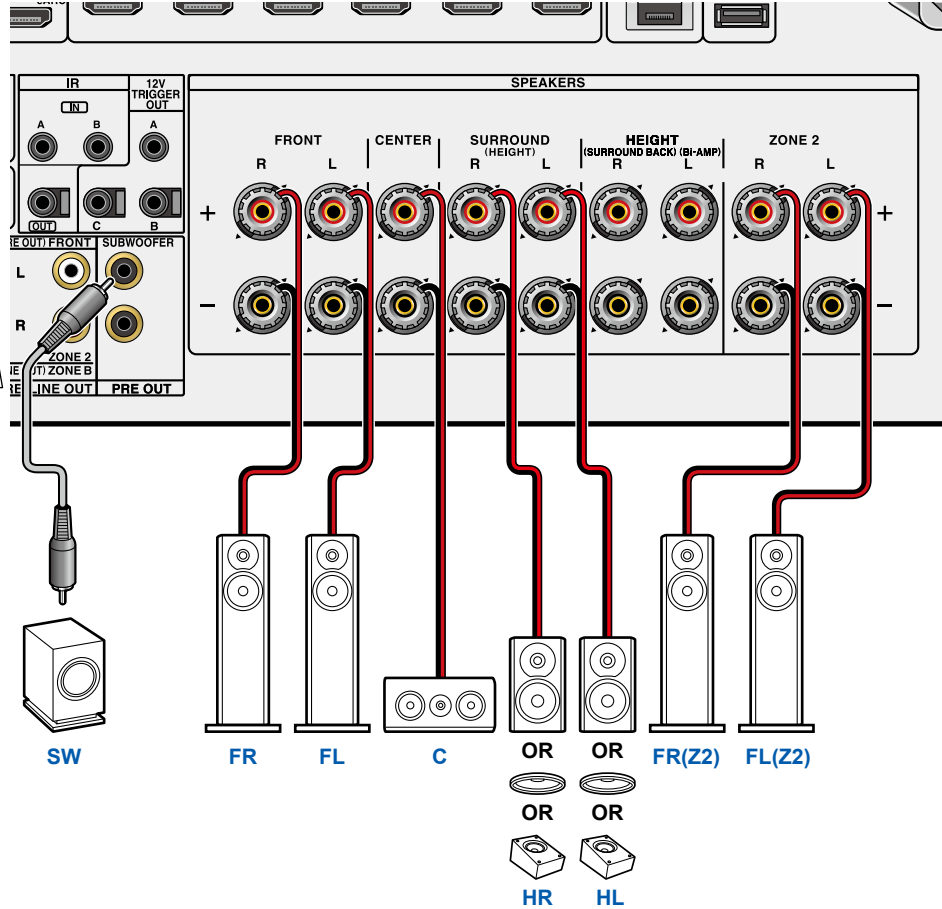
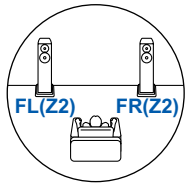

- 3.1ch
- 5.1ch
- 7.1ch
- 3.1.2ch
- 5.1.2ch



## 3.1.2 Channel System (Bi-Amping the Speakers)

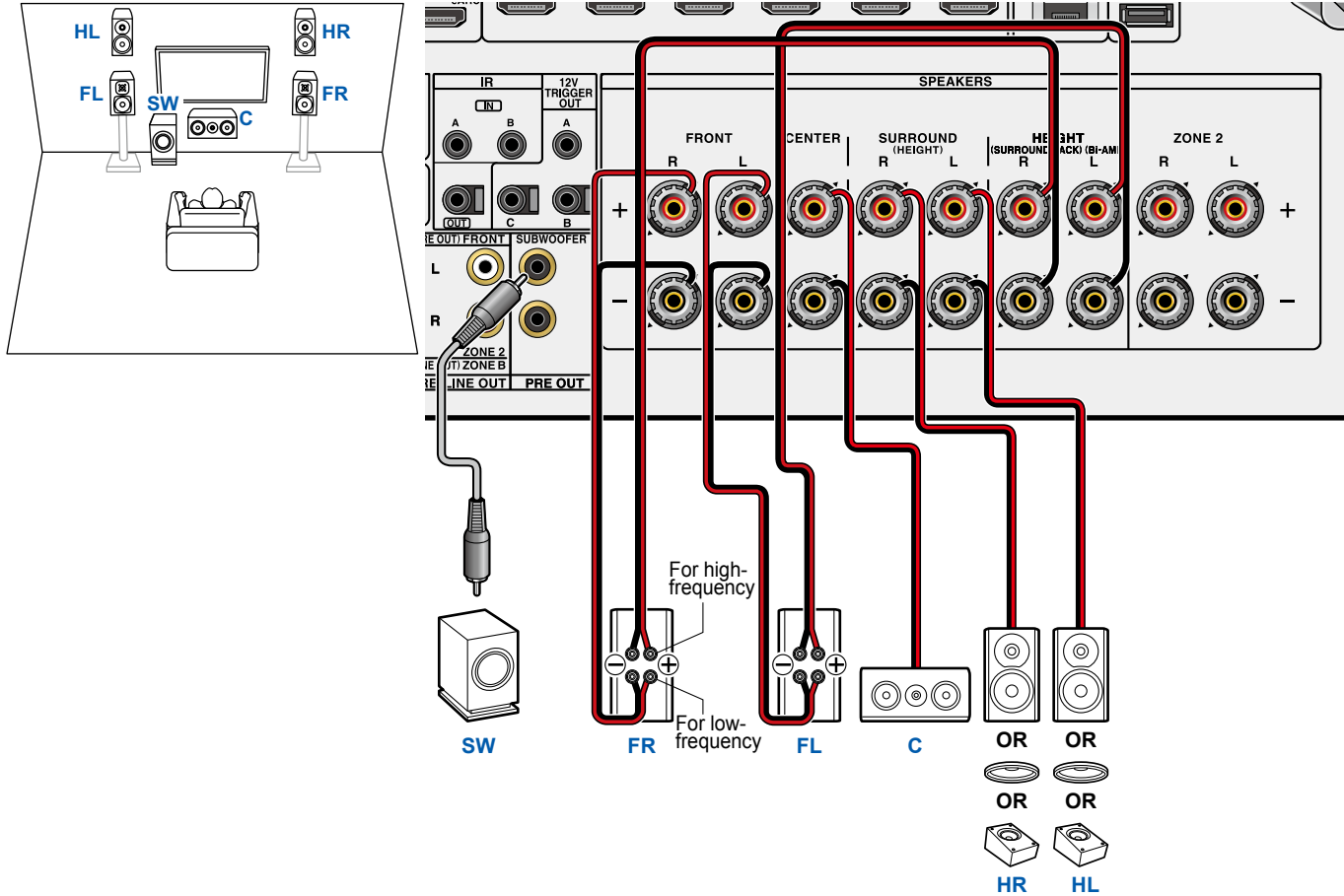

Be sure to remove the jumper bar connecting between the woofer jacks and tweeter jacks of the Bi-Amping supported speakers. Refer to the instruction manual of your speakers as well.

- 3.1ch
- 5.1ch
- 7.1ch
- 3.1.2ch
- 5.1.2ch



## 5.1.2 Channel System

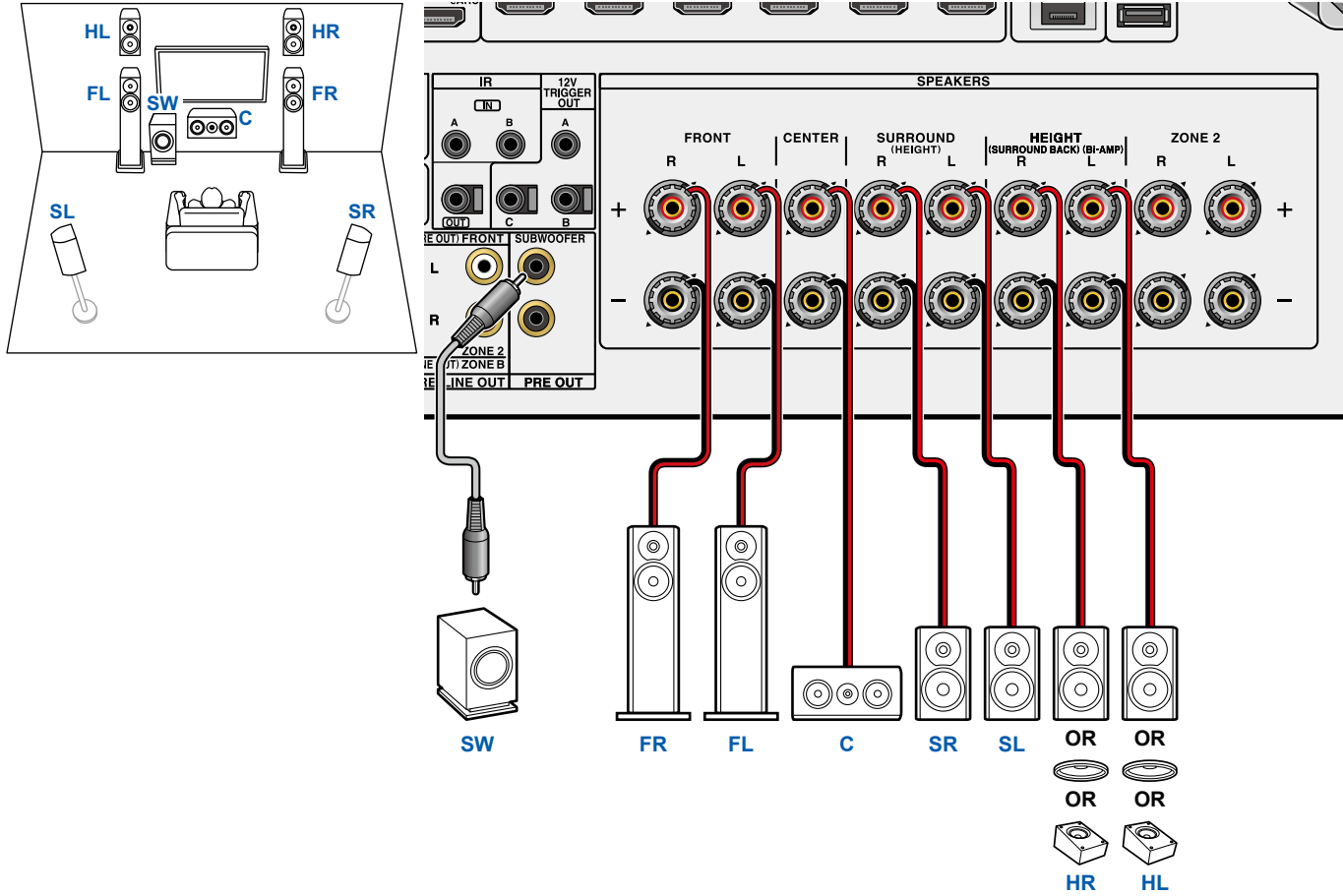

- 3.1ch
- 5.1ch
- 7.1ch
- 3.1.2ch
- 5.1.2ch



## 5.1.2 Channel System + ZONE SPEAKER

### MAIN ROOM

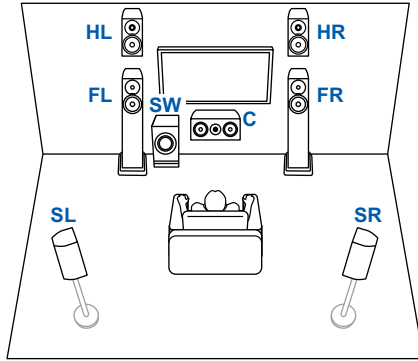

### ZONE 2

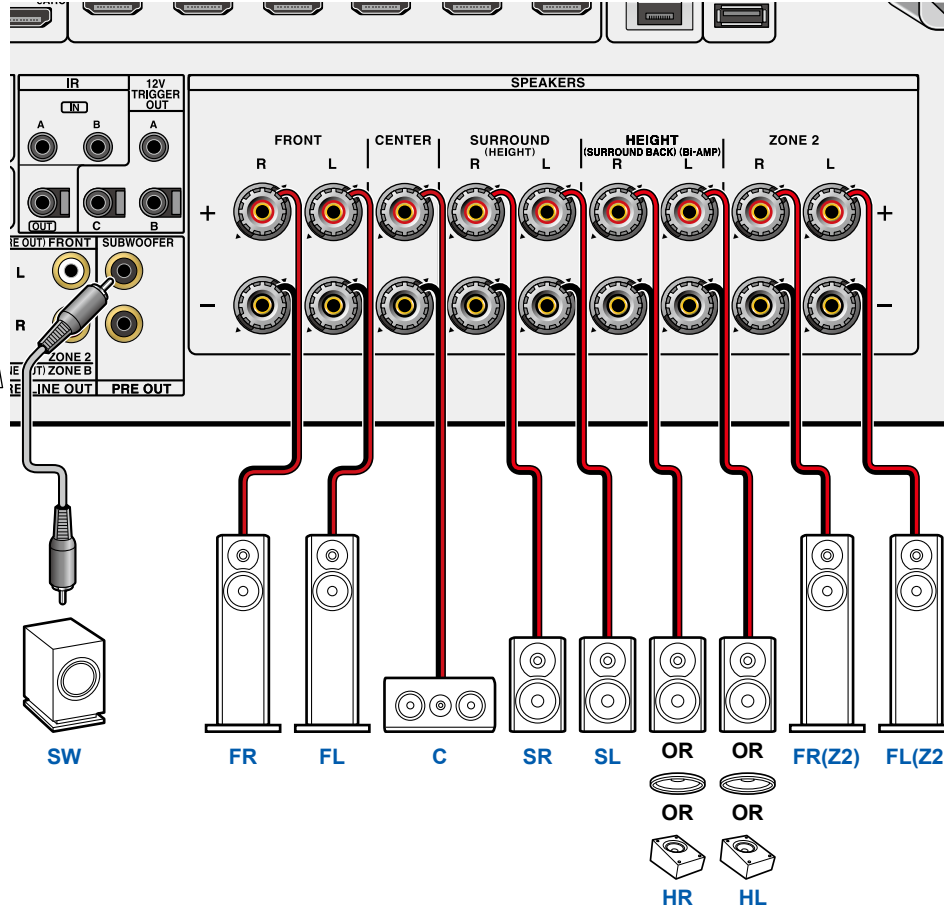
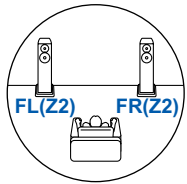

While ZONE 2 playback is being performed, height speakers installed in the main room cannot play audio.

- 3.1ch
- 5.1ch
- 7.1ch
- 3.1.2ch
- 5.1.2ch



## Connecting a Power Amplifier

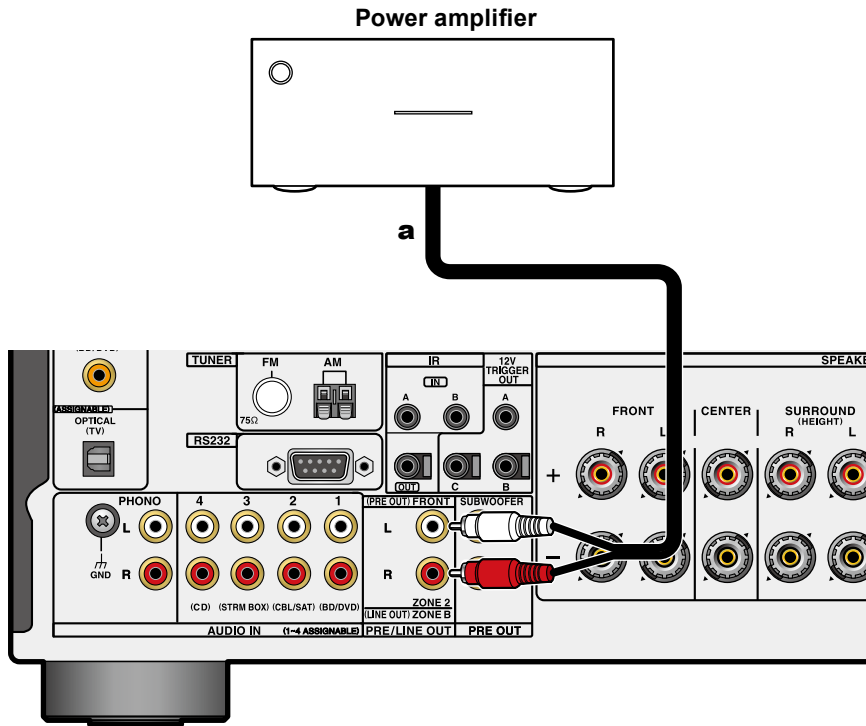

**a** Analog audio cable



You can connect a power amplifier to the unit and use the unit as a pre-amplifier in order to produce a large volume that cannot be output with the unit only. Connect the front speakers to the power amplifier. For details, refer to the power amplifier's instruction manual.

- Use the PRE OUT FRONT jacks for connection as show on the left.



### Setup

- Set "2. Speaker" - "Configuration" - "Speaker Channels" ( →[p104](#)) according to the number of channels of the connected speakers.
- Settings are required to output audio to the power amplifier. Press ⚙ on the remote controller, and set "2. Speaker" - "Configuration" - "Zone 2 Preout" ( →[p104](#)) to "Front".

3.1ch

5.1ch

7.1ch

3.1.2ch

5.1.2ch



## Connections

|                                                                                  |           |
|----------------------------------------------------------------------------------|-----------|
| <b>Connecting the TV</b>                                                         | <b>48</b> |
| <b>Connecting the SUB Monitor</b>                                                | <b>49</b> |
| <b>Connecting Playback Devices</b>                                               | <b>50</b> |
| <b>Connecting an AV Component in a Separate Room<br/>(Multi-zone Connection)</b> | <b>52</b> |
| <b>Connecting Antennas</b>                                                       | <b>54</b> |
| <b>Network Connection</b>                                                        | <b>55</b> |
| <b>Connecting the Power Cord</b>                                                 | <b>58</b> |



## Connecting the TV

By connecting a TV to this unit, you can show the video from AV devices connected to this unit on the TV and also play the sound from the TV through this unit.

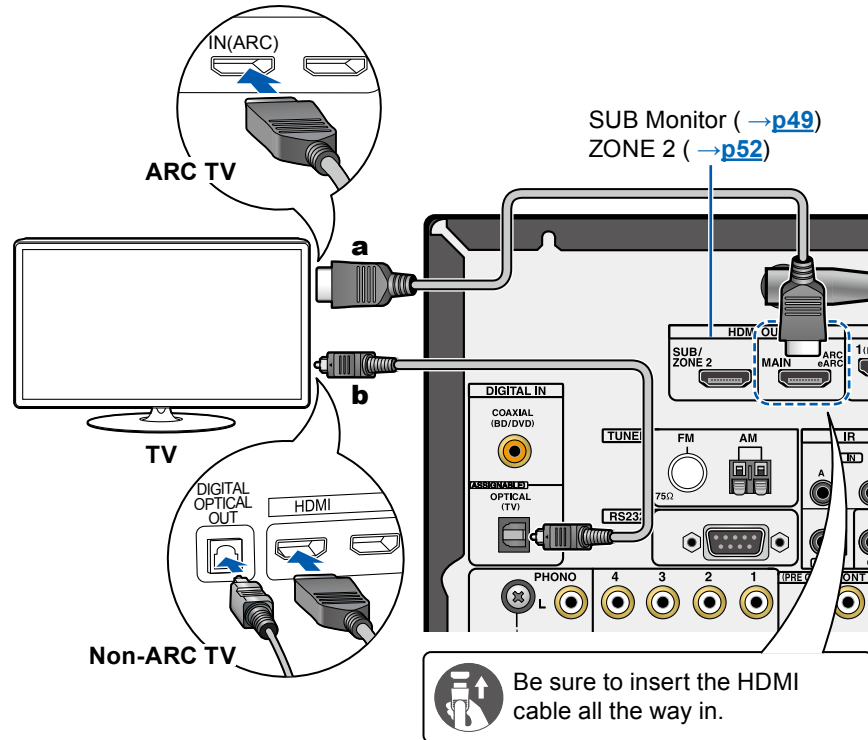

**a** HDMI cable, **b** Digital optical cable



### To ARC/eARC TV

If the TV supports the ARC (Audio Return Channel) function (\*), use only the HDMI cable to connect with the TV. Use the ARC-compatible HDMI IN jack of the TV for connection. You connect the HDMI cable to the HDMI OUT MAIN jack labeled "ARC" on the receiver side.

### To Non-ARC TV

If the TV does not support the ARC (Audio Return Channel) function (\*), connect an HDMI cable and digital optical cable.

- If you use a cable set-top box, etc. connected to the input jack of this unit to watch TV (without using a TV's built-in tuner), connection with a digital optical cable is not required.



#### Setup

- When not using the ARC function, press on the remote controller, then set "6.Hardware" - "HDMI" - "Audio Return Channel (eARC supported)" ( →p115) to "Off".

(\*)The ARC function and eARC function transmit the audio signals of the TV via an HDMI cable, and plays the audio of the TV on this unit. To check if the TV supports the ARC function and eARC function, refer to the instruction manual of the TV, etc.

ARC/eARC compatible audio formats ( →p161)

- Settings are required when 4K or 8K high-quality video is to be played. Refer to "HDMI 4K/8K Signal Format" ( →p101) for information on the settings. Also, use an HDMI cable that supports 4K or 8K video.





## Connecting the SUB Monitor

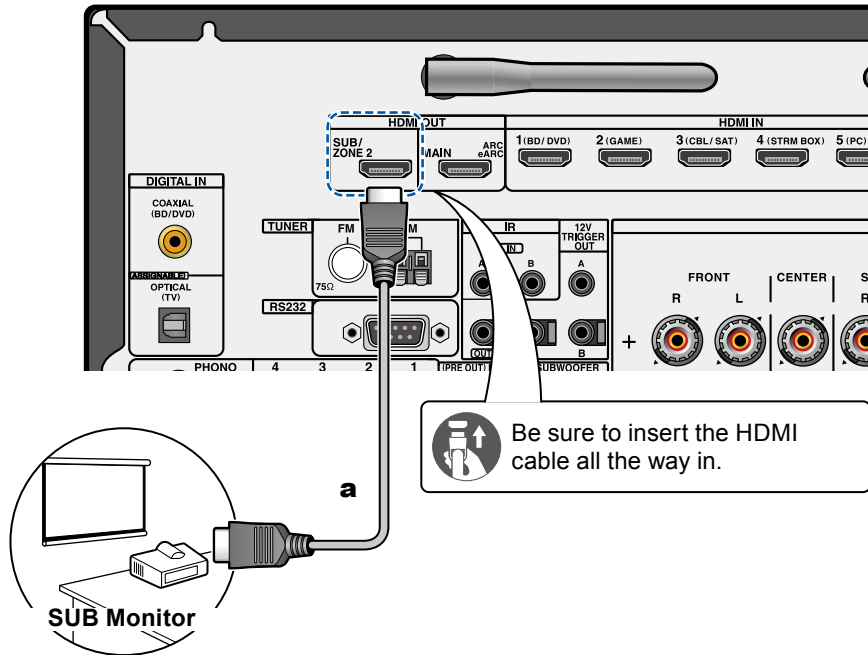

### SUB Monitor

This unit has multiple HDMI OUT jacks, and another TV or projector can be connected to the HDMI OUT SUB jack.

- Switch between MAIN and SUB using the HDMI Main/Sub button on the remote controller ( →[p15](#)) or "Quick Menu" ( →[p70](#)). Note that this jack is not ARC-compatible.
- If devices with different resolutions are connected to HDMI OUT MAIN jack and SUB jack, images are output with the lower resolution.

a HDMI cable



## Connecting Playback Devices

### Connecting an AV Component with HDMI Jack Mounted

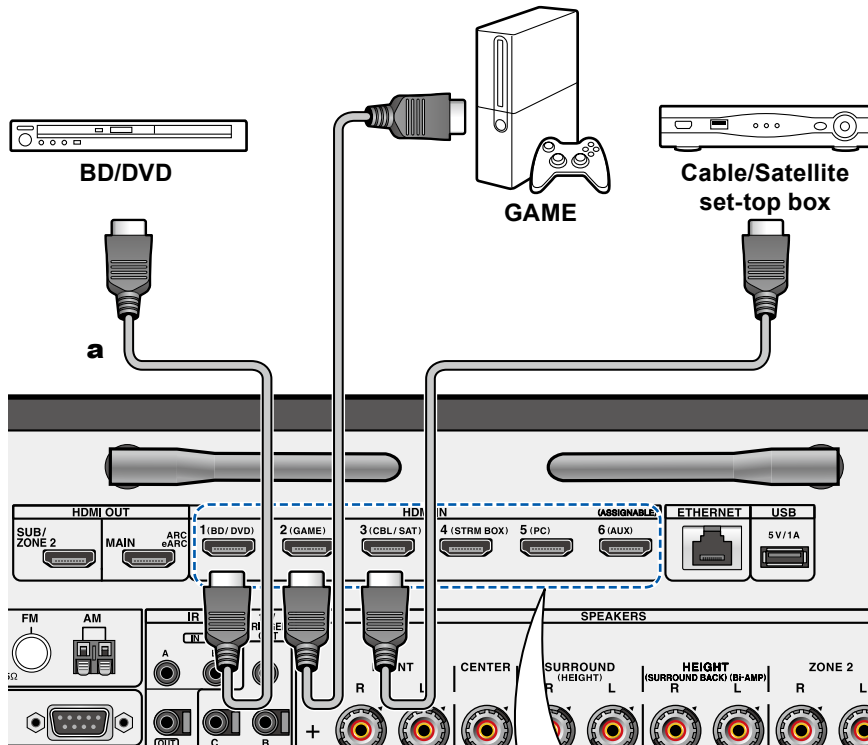

 Be sure to insert the HDMI cable all the way in.

This is a connection example of an AV component equipped with an HDMI jack. When connecting with an AV component that conforms to the CEC (Consumer Electronics Control) standard, you can use the HDMI CEC function (\*) that enables linking with input selectors, etc. and the HDMI Standby Through function that can transmit video and audio signals of the AV component to the TV even if this unit is in standby mode.

- Settings are required when 4K or 8K high-quality video is to be played. Refer to "HDMI 4K/8K Signal Format" (→[p101](#)) for information on the settings. Also, use an HDMI cable that supports 4K or 8K video.
- The corresponding resolution is different depending on the HDMI jack connected. See "Corresponding input resolutions" (→[p162](#)) for details.
- To enjoy digital surround sound including Dolby Digital, set the audio output of the connected Blu-ray Disc player etc. to the Bitstream output.

(\*)The HDMI CEC function: This function enables various linking operations with CEC-compliant devices, such as switching input selectors interlocking with a CEC-compliant player, switching audio output between TV and this unit or adjusting the volume using the remote controller of a CEC-compliant TV, and automatically switching this unit to standby when the TV is turned off.

a HDMI cable



# Connecting an Audio Component

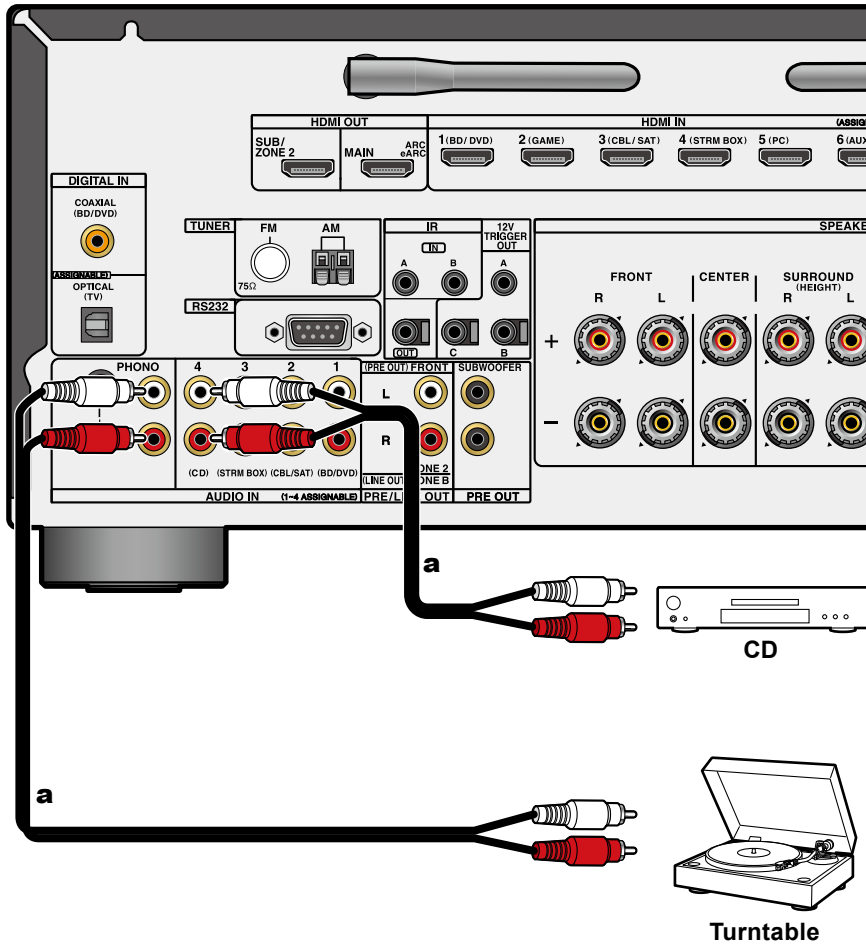

This is a connection example of an audio component. Connect a CD player using an analog audio cable. You can also connect a turntable that has an MM-type cartridge to the PHONO jack.

- If the turntable has a built-in phono equalizer, connect it to any of the AUDIO IN jacks other than the PHONO jack. Further, if the turntable uses an MC type cartridge, install a phono equalizer compatible with the MC type cartridge between the unit and the turntable, and then connect it to any of the AUDIO IN jacks other than the PHONO jack.

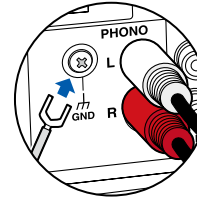

If the turntable has a ground wire, connect it to the GND terminal of this unit.

**a** Analog audio cable



## Connecting an AV Component in a Separate Room (Multi-zone Connection)

### Connecting a TV (ZONE 2)

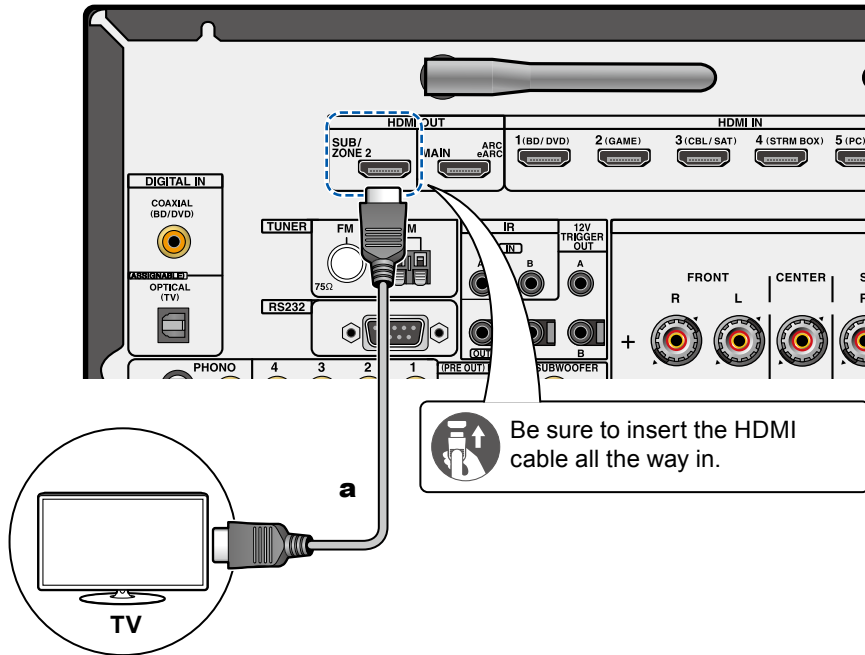

a HDMI cable

While a disc is played on a Blu-ray Disc player in the main room (where this unit is located), you can play the video and audio of the same Blu-ray Disc player or another AV component on the TV equipped with an HDMI IN jack in a separate room (ZONE 2). Note that only the devices connected to the HDMI IN1 to IN3 jacks can be played on the TV in the separate room.

- Audio from an externally connected AV component can be output only when the audio is 2 ch PCM audio signal. Also, the audio output of the AV component may need to be changed to the PCM output.



#### Setup

- When video and audio via HDMI input are output to ZONE 2, set "1. Input/Output Assign" - "TV Out / OSD" - "Zone 2 HDMI" (→[p101](#)) to "Use" on the Setup menu. Note that when "Zone 2 HDMI" is set to "Use", the resolution of the video that can be output by the HDMI OUT SUB/ZONE 2 jack will be limited to "4K Standard" (→[p101](#)).



## Connecting an Integrated Amplifier (ZONE 2)

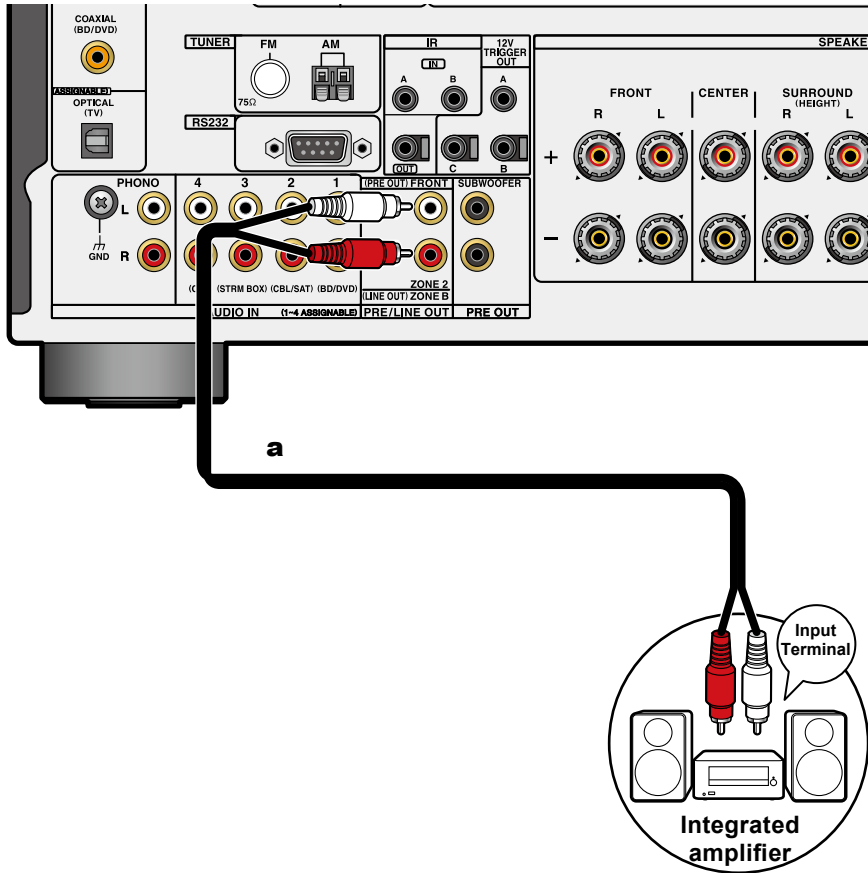

**a** Analog audio cable



You can enjoy 2 ch audio in the separate room (ZONE 2) while performing playback in the main room (where this unit is located). Use an analog audio cable to connect the ZONE 2 PRE/LINE OUT terminal on this unit to the input jack on an integrated amplifier in the separate room.

- To output audio from an externally connected AV component to ZONE 2, connect it to any of HDMI IN1 to IN3 jacks. If the AV component is not equipped with an HDMI jack, use a digital coaxial cable, digital optical cable or analog audio cable. Also, the audio from externally connected AV components can be output to ZONE 2 only when the audio is analog or 2 ch PCM signal. When the AV component is connected to this unit with a digital coaxial cable or digital optical cable, change the audio output of the AV component to the PCM output.



### Setup

- Settings are required to output audio to ZONE 2. Press  on the remote controller, and set "2. Speaker" - "Configuration" - "Zone 2 Preout" (→ [p104](#)) to "Zone 2".
- When connecting an Integrated Amplifier that does not have a volume control, in the Setup menu, set "7. Multi Zone" - "Zone 2" - "Output Level" to (→ [p125](#)) "Variable (Default Value: Fixed)". If you do not set this, the volume output will be very loud and there is a danger of damage to the Integrated Amplifier, speakers, etc. When connecting an Integrated Amplifier that has a volume control, leave this as "Fixed".

# Connecting Antennas

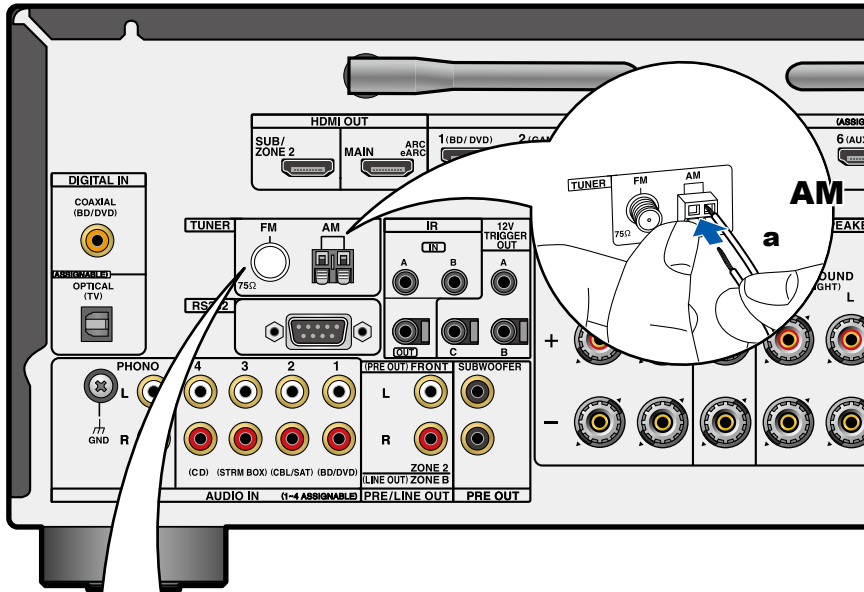

Connect the antenna to this unit, and set up the antenna at the best position for listening while receiving radio signals. Attach the indoor FM antenna to the wall using push pins or adhesive tape.

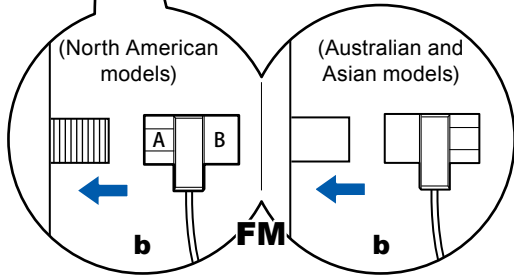
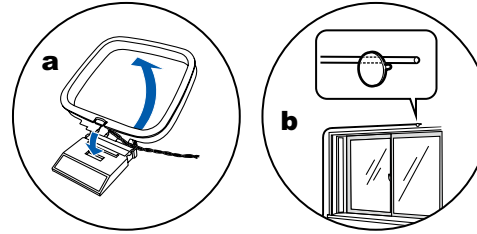

**a** AM loop antenna, **b** Indoor FM antenna



## Network Connection

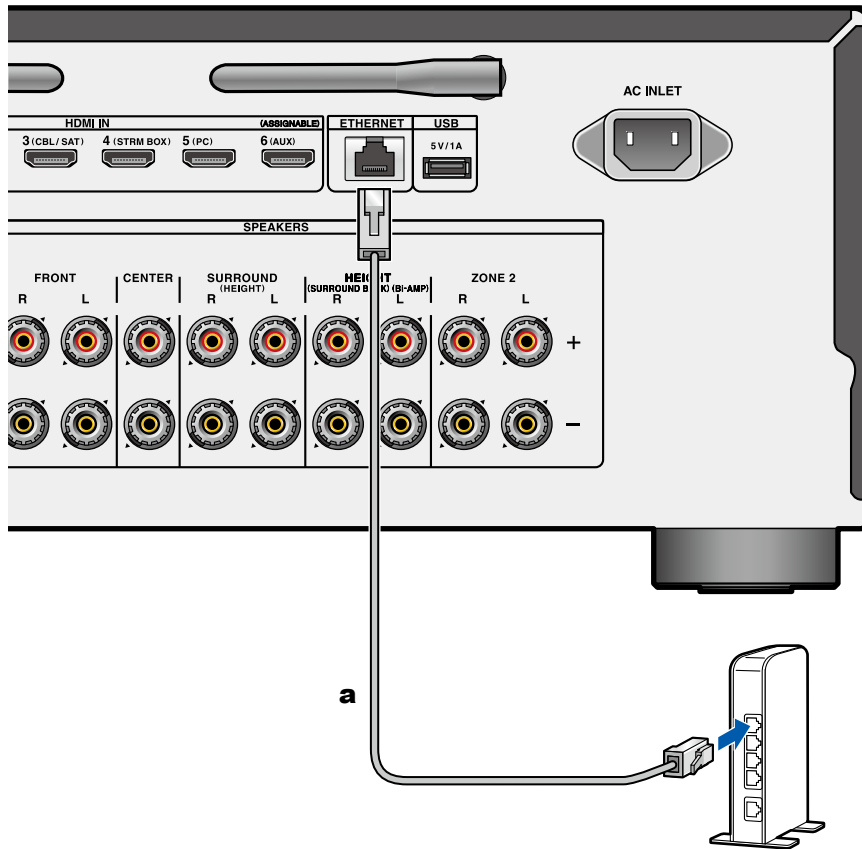

This unit can be connected to the network using a wired LAN or Wi-Fi (wireless LAN). You can enjoy network functions such as Internet radio by network connection. If connection is made by the wired LAN, connect the router and the ETHERNET jack with the Ethernet cable as shown in the illustration. To connect by Wi-Fi, select your desired setting method in "Network Connection" ( →[p130](#)) of Initial Setup, and then follow the on-screen instructions. To configure the setting on the Setup menu after the completion of Initial Setup, press the ⚙ button on the remote controller, and select "6. Hardware" - "Network" to make the setting ( →[p116](#)). For the Wi-Fi connection, stand the wireless antenna for use.

**a** Ethernet cable



## Connecting External Control Devices

### IR IN/OUT port

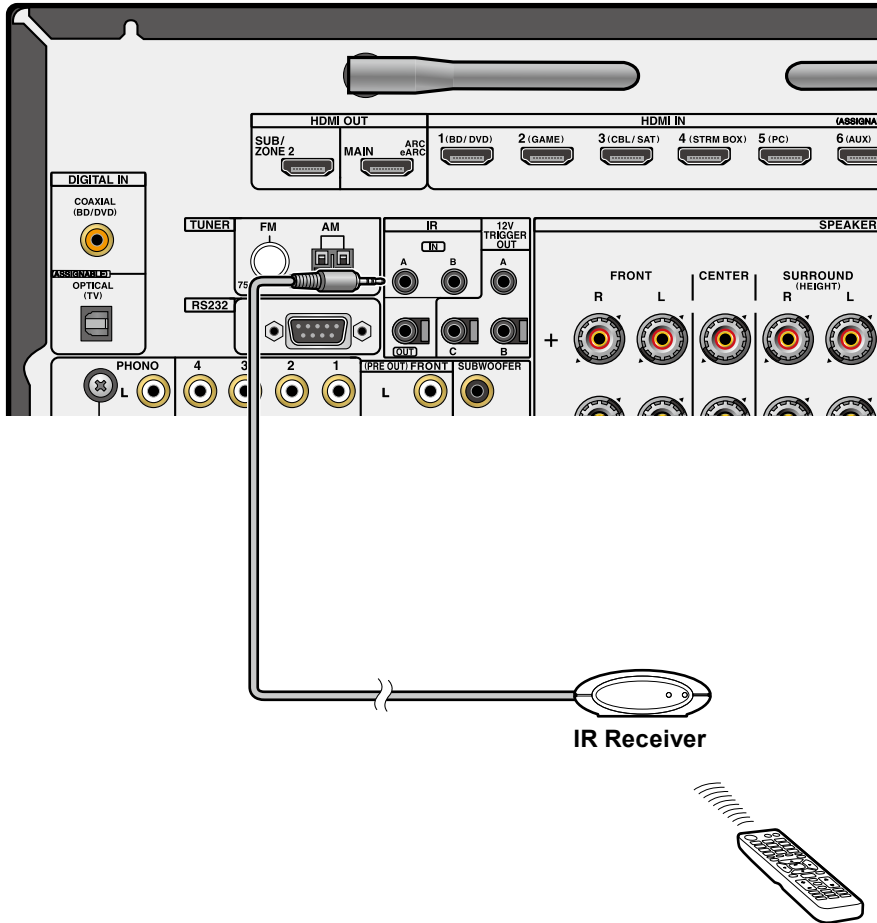

When connecting a remote control receiver unit consisting of an IR Receiver, etc. to this unit, operation using the remote controller is possible even if the remote control signal is difficult to reach (due to installation in the cabinet, etc.). It is also possible to operate this unit from other room such as ZONE 2 with a remote controller, or operate other devices with the remote controller by connecting other devices to this unit. For adopting a remote control receiver unit, contact the specialized stores.

- For the type of cable required for connection, refer to the operation manual, etc. of the remote control receiver unit.





## 12V TRIGGER OUT jack

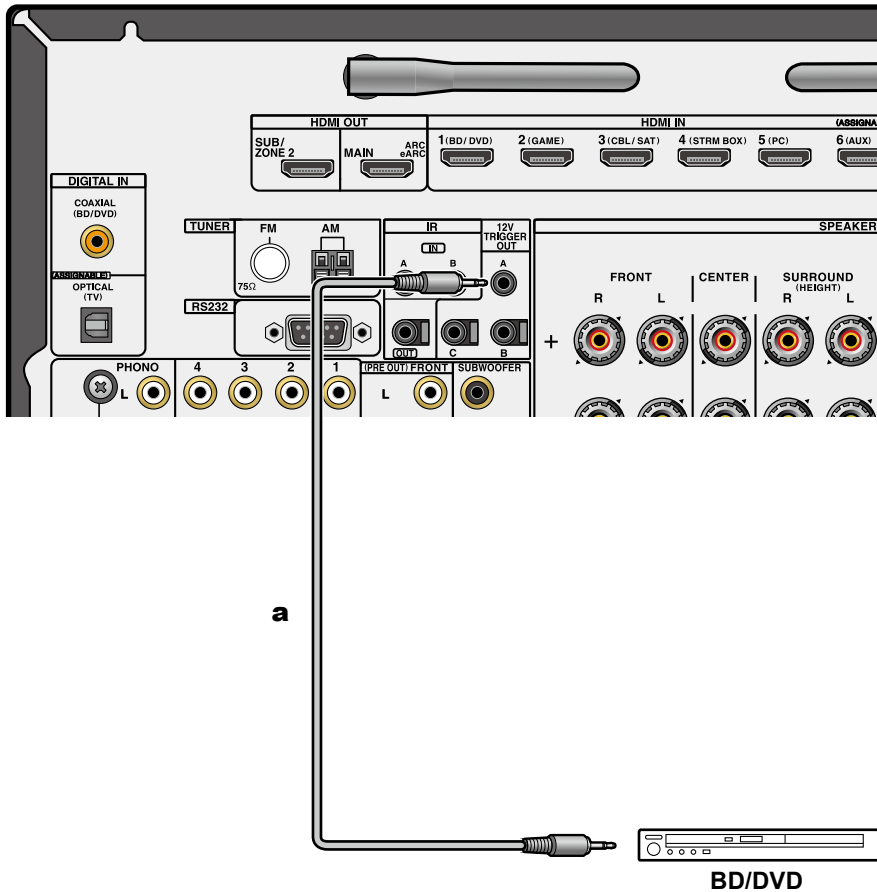

**a** Monaural mini plug cable ( $\varnothing 1/8''$  / 3.5 mm)

When connecting a device equipped with a TRIGGER IN jack such as a BD/DVD player to this unit, the device can be turned on or set to standby by interlocking the operation on this unit. When the desired input is selected on the unit, power link operation will be activated with a control signal of maximum 12 V/100 mA from the 12V TRIGGER OUT A jack or maximum 12 V/25 mA when using the 12V TRIGGER OUT B or C jack. You can select the zone to output the control signal by setting each of the inputs.

- For connection, use a monaural mini plug cable ( $\varnothing 1/8''$  / 3.5 mm) without resistance. Do not use a stereo mini plug cable.



### Setup

- Settings are required to output control signals from the 12 V TRIGGER OUT jack. Press  on the remote controller, then with "6. Hardware" - "12V Trigger A", "12V Trigger B", or "12V Trigger C" ( → [p122](#), [p123](#)), set the desired input to "Main" or "Zone 2".



## Connecting the Power Cord

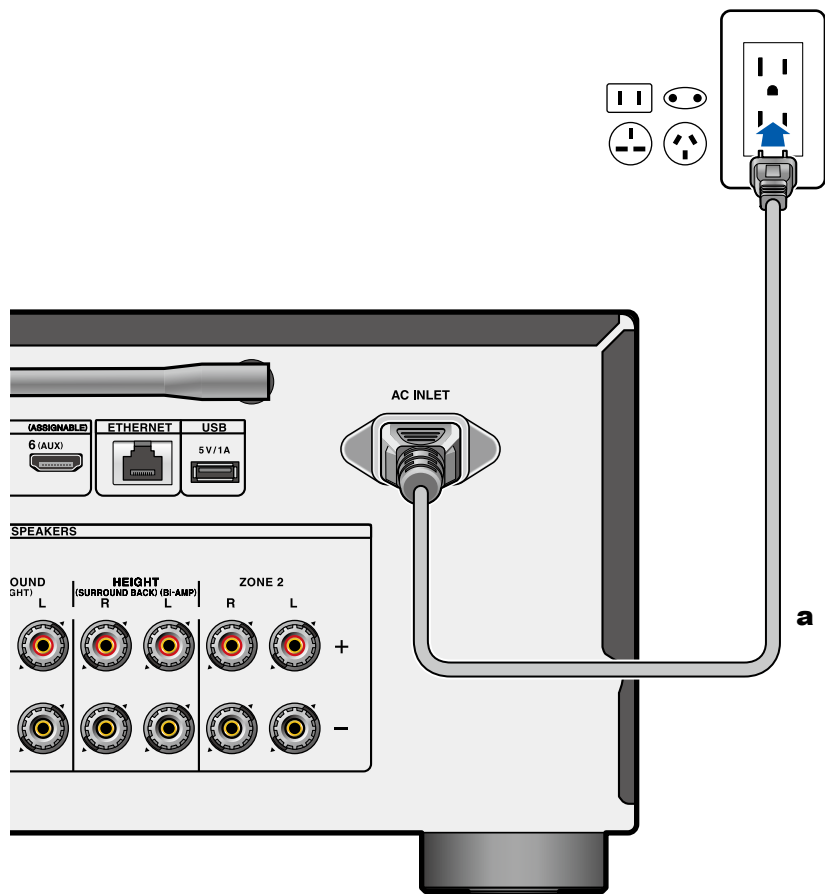

Connect the power cord after all the connections are completed.

- This model includes a removable power cord. Be sure to connect the power cord to the AC INLET of the unit first, and then connect it to the outlet. Always disconnect the outlet side first when disconnecting the power cord.

**a** Power cord



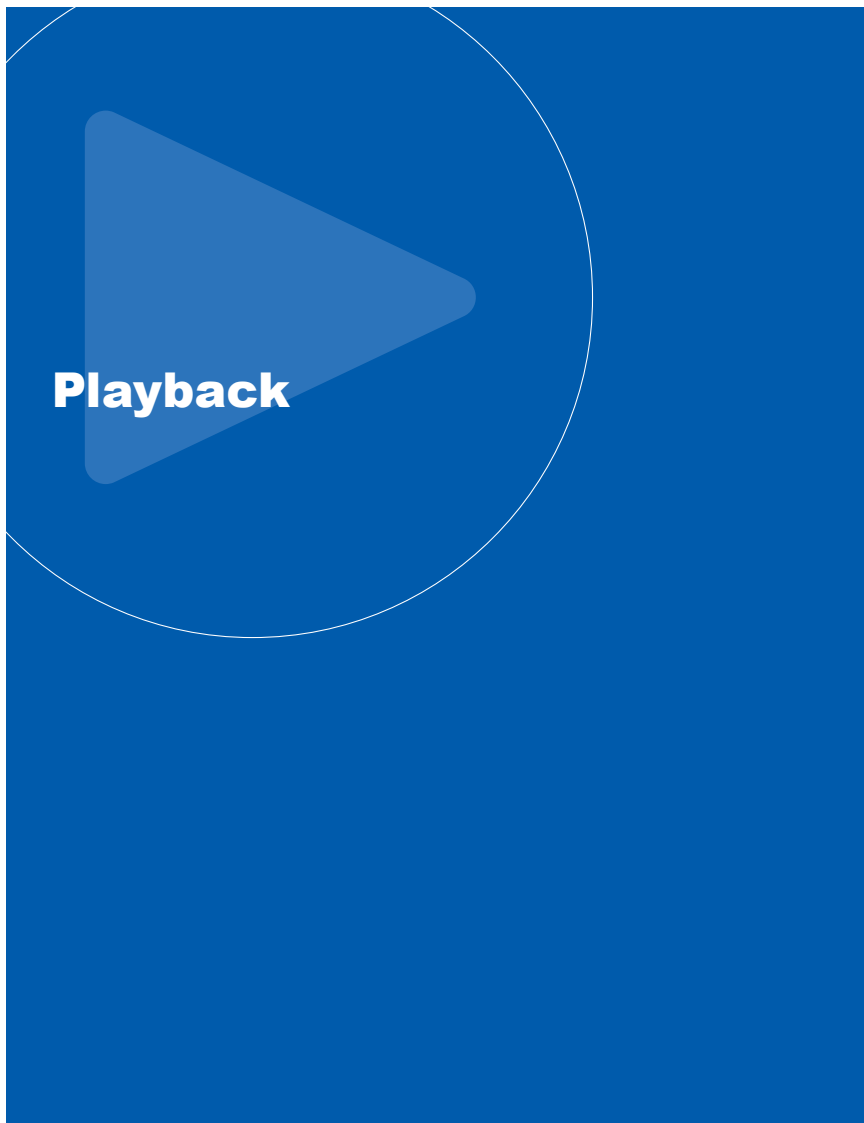

## Basic Operations

|                               |           |
|-------------------------------|-----------|
| <b>AV Component Playback</b>  | <b>60</b> |
| <b>BLUETOOTH® Playback</b>    | <b>61</b> |
| <b>Listening To the Radio</b> | <b>64</b> |
| <b>Listening Mode</b>         | <b>68</b> |
| <b>Quick Menu</b>             | <b>70</b> |

## Network Services

|                                                 |           |
|-------------------------------------------------|-----------|
| <b>Spotify</b>                                  | <b>72</b> |
| <b>AirPlay®</b>                                 | <b>73</b> |
| <b>DTS Play-Fi®</b>                             | <b>75</b> |
| <b>Amazon Alexa</b>                             | <b>76</b> |
| <b>Amazon Music</b>                             | <b>78</b> |
| <b>Connecting the Sonos System for Playback</b> | <b>80</b> |
| <b>Internet Radio</b>                           | <b>82</b> |

## Convenience functions

|                                              |           |
|----------------------------------------------|-----------|
| <b>Multi-zone</b>                            | <b>84</b> |
| <b>Playing different audio and video</b>     | <b>87</b> |
| <b>USB Storage Device</b>                    | <b>88</b> |
| <b>Music Server</b>                          | <b>91</b> |
| <b>Play Queue</b>                            | <b>94</b> |
| <b>Connecting a transmitter for playback</b> | <b>96</b> |



## AV Component Playback

You can play the audio from AV components, such as Blu-ray disc players through this unit.

- When a TV is connected to the HDMI OUT SUB jack, use the HDMI Main/Sub button or "Quick Menu" ( →p70) to switch between MAIN and SUB.

### Basic Operations

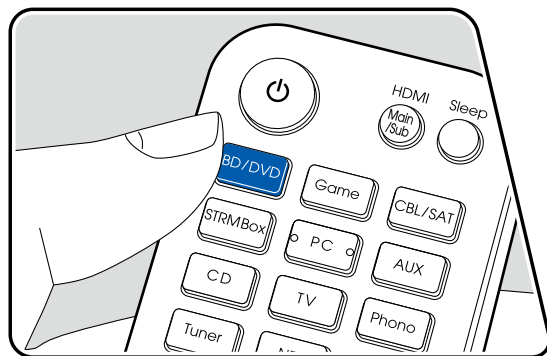
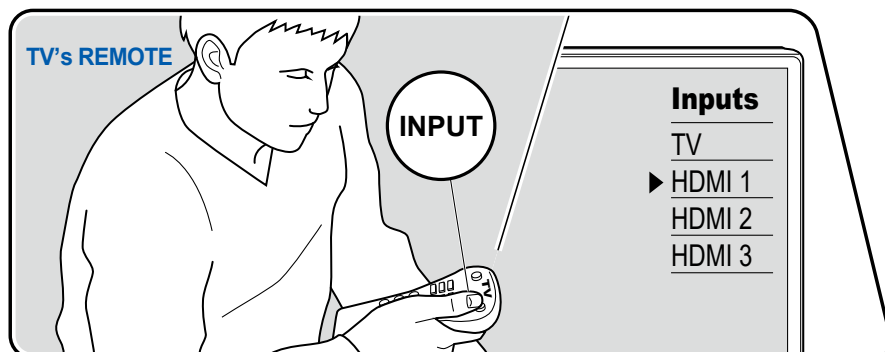

Perform the following procedure when this unit is on.

1. Switch the input on the TV to the input connected to the unit.
2. Press the input selector whose name is the same as that of the jack to which the player is connected.

For example, press BD/DVD to play the player connected to the BD/DVD jack. Press TV to listen to the sound of the TV.

- When the CEC link function works, the input switches automatically when a CEC compliant TV or player is connected to this unit using HDMI connection.

3. Start play on the AV component.

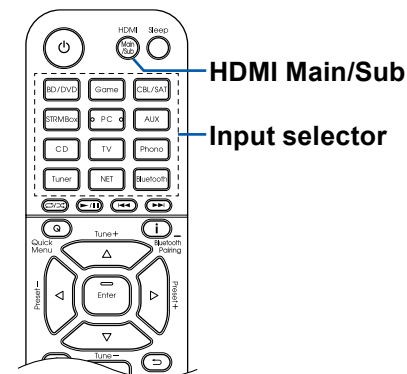

## BLUETOOTH® Playback

You can wirelessly play music on a smartphone or other BLUETOOTH wireless technology enabled device through the speakers connected to this unit. It is also possible to transmit the audio from this unit to BLUETOOTH enabled headphones, wireless speakers, etc.

### Playing audio from BLUETOOTH wireless technology enabled devices with this unit

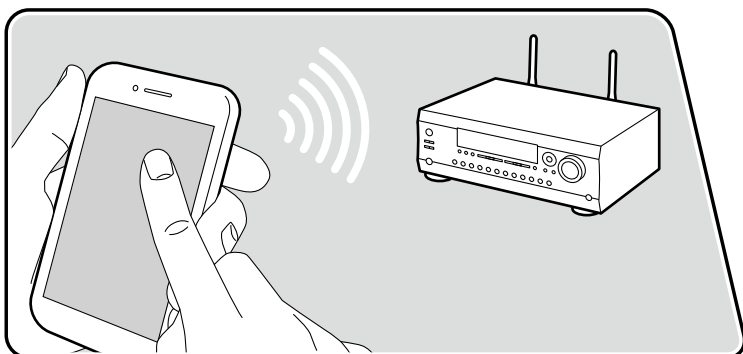

The illustration shows an image.

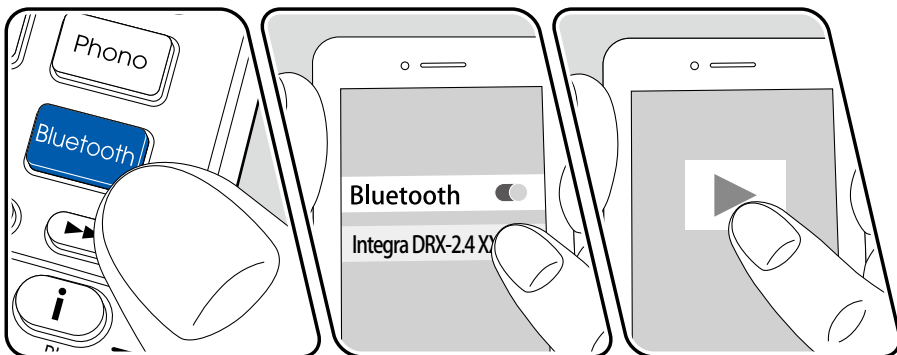

Perform the following procedure when this unit is on.

#### Pairing

1. When you press the Bluetooth button, "Now Pairing..." appears on the display, and the pairing mode is enabled.

Now Pairing...

2. Enable (turn on) the BLUETOOTH function of the BLUETOOTH enabled device, and then select this unit from among the devices displayed. If a password is requested, enter "0000".
  - This unit is displayed as "Integra DRX-2.4 XXXXXX". This display can be changed using the Friendly Name function (→p117) or Integra Control Pro (→p132) (available on iOS or Android™).
  - To connect another BLUETOOTH enabled device, press and hold the **i** button at least 5 seconds, and then perform step 2. This unit can store the pairing information of up to 8 paired devices.
  - The coverage area is approx. 48/15 m. Note that connection is not always guaranteed with all BLUETOOTH enabled devices.

#### Playing Back

1. Perform the connection procedure on the BLUETOOTH enabled device.
2. Playing the music file.
 

The input on this unit automatically switches to "BLUETOOTH". Turn up the volume of the BLUETOOTH enabled device to an appropriate level.

  - Due to the characteristics of BLUETOOTH wireless technology, the sound produced on this unit may slightly be behind the sound played on the BLUETOOTH enabled device.



# Transmitting audio from this unit to BLUETOOTH wireless technology enabled devices

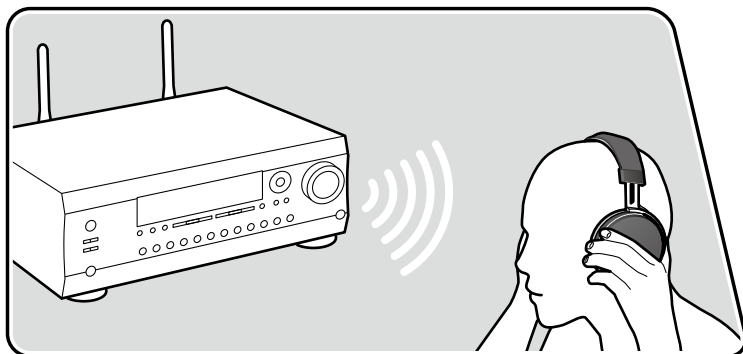

The illustration shows an image.

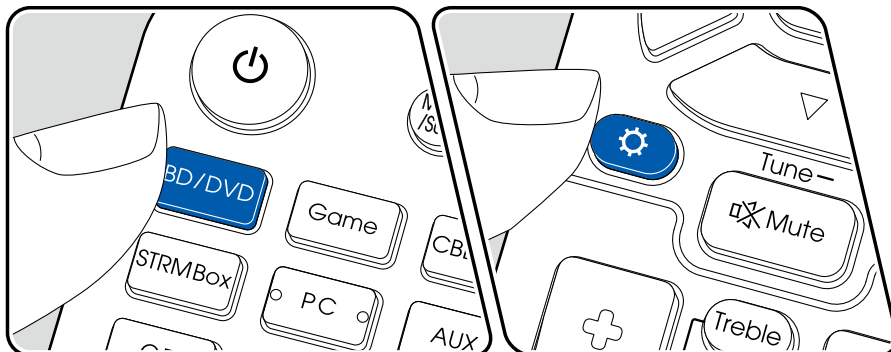

## Pairing

1. Press the input selector you want to play.
  - Select a source other than "BLUETOOTH". This function does not work if you select "BLUETOOTH".
  - This function can be used in one location, either the main room (where this unit is located) or a separate room (ZONE 2). When using in the main room, set the input selector for the separate room to anything other than "BLUETOOTH". Set the input selector similarly for the main room when using in the separate room.
2. Press the ⚙ button on the remote controller, select "6. Hardware" - "Bluetooth" - "Bluetooth Transmitter", and press the Enter button.
3. In "Bluetooth Transmitter", select "On".

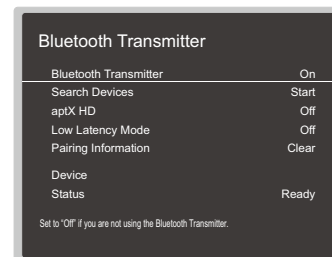

4. In "Search Devices", press Enter.
  - The search starts for BLUETOOTH wireless technology enabled devices that are able to receive, then a list of relevant devices is displayed.
5. Select the device you want to output the audio from, and when you press Enter the message "Now Pairing..." is displayed and the two are paired.
  - Depending on the BLUETOOTH wireless technology enabled device, you may need to pair manually. If the device name does not appear in the list, check the settings of the BLUETOOTH wireless technology enabled device.



## Playing Back

1. Do the play operations on the AV component connected to this unit. Do the play operations on this unit when the input is TUNER or NET.  
You cannot adjust the volume of the BLUETOOTH wireless technology enabled device on this unit. Adjust on the connected BLUETOOTH wireless technology enabled device.
  - You cannot transmit audio to multiple BLUETOOTH wireless technology enabled devices from this unit.
  - Audio is also output from the speakers connected to this unit.
  - The coverage area is approx. 48' / 15 m. Note that connection is not always guaranteed with all BLUETOOTH enabled devices.
  - When "Bluetooth Transmitter" is "On" and in the following cases, when this unit detects a paired BLUETOOTH wireless technology enabled device, it will automatically reconnect with that device.
    - When the power is turned on again after the unit is switched to standby
    - While other than "BLUETOOTH" is selected
    - When the "NET" input is selected and there is audio output from a network service/content (some services excluded)
 When not using this function, select "Off" in "Bluetooth Transmitter" to cancel the connection. Also disconnect on the receiving device (if disconnection is possible on the receiving device).
  - Audio cannot be output from a BLUETOOTH wireless technology enabled device in the following cases:
    - When the audio file is DSD format
    - When playing audio from one of the following network services: Chromecast built-in, Amazon Music, Amazon Alexa, AirPlay, DTS Play-Fi
  - Sound quality adjustments and listening modes of this unit cannot be applied to the output audio.



## Listening To the Radio

You can receive AM/FM radio stations on this unit with the built-in tuner.

### Listening To the AM/FM Radio

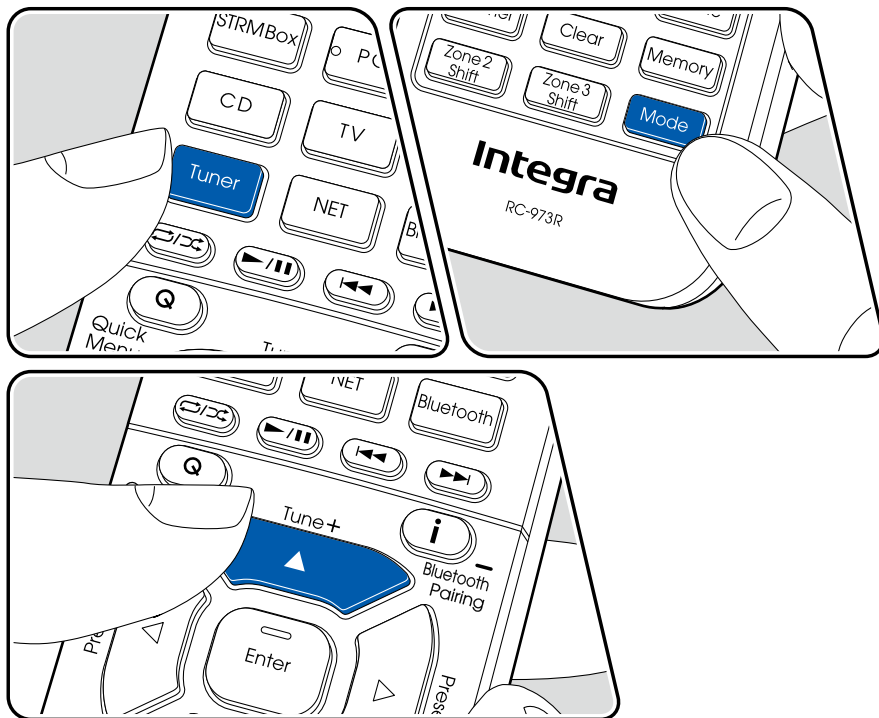

### Tuning into a Radio Station

Perform the following procedure when this unit is on.

#### ■ Tuning Automatically

1. Press Tuner repeatedly to select either "AM" or "FM".
2. Press Mode repeatedly to display "TunMode: Auto" on the display.

TunMode: Auto

3. When you press the cursors ▲ / ▼, automatic tuning starts, and searching stops when a station is found. When tuned in to a radio station, the "TUNED" indicator on the display lights up. When tuned in to an FM radio station, the "FM ST" indicator lights up.

**When FM broadcasts reception is poor:** Perform the procedure for "Tuning Manually" (→p65). Note that if you tune manually, the reception for FM broadcasts will be monaural rather than stereo, irrespective of the sensitivity of the reception.





## ■ Tuning Manually

Note that if you tune manually, the reception for FM broadcasts will be monaural rather than stereo, irrespective of the sensitivity of the reception.

1. Press Tuner repeatedly to select either "AM" or "FM".
2. Press Mode repeatedly to display "TunMode: Manual" on the display.

TunMode: Manual

3. While pressing the cursors ▲ / ▼, select the desired radio station.
  - Each time you press the cursors ▲ / ▼, the frequency changes by 1 step. If the button is held down, the frequency changes continuously, and if the button is released, the frequency stops changing.

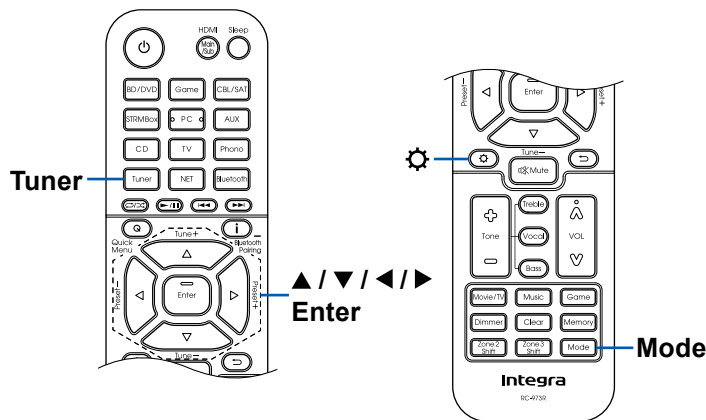

## ■ Frequency step setting

Press , and using the cursors and Enter, select "8. Miscellaneous" - "Tuner" - "AM/FM Frequency Step" or "AM Frequency Step", and then select the frequency step for your area. Note that when this setting is changed, all radio presets are deleted.

## Using RDS (Australian and Asian models)

RDS stands for Radio Data System, and is a method of transmitting data in FM radio signals. In regions where RDS can be used, when you tune in to a radio station broadcasting program information, the radio station name is displayed on the display. When you press the  button on the remote controller in this state, you can use the following functions.

### ■ Display Text Information (Radio Text)

1. While the name of the station is being displayed on the display, press the  button on the remote controller once.
  - The Radio Text (RT), which is text information delivered by the station, is displayed scrolling across the display. "No Text Data" is displayed when no text information is delivered.

### ■ Search for Stations by Program Type

1. While the name of the station is being displayed on the display, press the  button on the remote controller twice.
  - If none of the Program Types are set for the radio station under reception, "None" is displayed.
2. Press the cursor buttons ◀ / ▶ on the remote controller to select the Program Type you want to search for, and then press the Enter button to start the search.
  - The Program Types displayed are as follows: None / News (News reports) / Affairs (Current affairs) / Info (Information) / Sport / Educate (Education) / Drama / Culture / Science (Science and technology) / Varied / Pop M (Pop music) / Rock M (Rock music) / Easy M (Middle of the road music) / Light M (Light classics) / Classics (Serious classics) / Other M (Other music) / Weather / Finance / Children (Children's programmes) / Social (Social affairs) / Religion / Phone In / Travel / Leisure / Jazz (Jazz music) / Country (Country music) / Nation M (National music) / Oldies (Oldies music) / Folk M (Folk music) / Document (Documentary)
  - The information displayed may not match the content delivered by the station.
3. When a station is found, the station blinks on the display. Pressing the Enter button in this state will receive that station. If you don't press the Enter button, the unit starts to search for another station.
  - If no stations are found, the message "Not Found" is displayed.



- Unusual characters may be displayed when the unit receives unsupported characters. This is not a malfunction. Also, if the signal from a station is weak, information may not be displayed.



## Presetting a Radio Station ( →[p67](#))



## Presetting a Radio Station

### Registration Procedure

You can preset up to 40 of your favorite AM/FM radio stations.

After tuning in to the AM/FM radio station you want to register, perform the following procedure.

1. Press Memory so that the preset number on the display blinks.

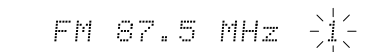

2. While the preset number is blinking (approx. 8 seconds), repeatedly press the cursors ◀/▶ to select a number between 1 and 40.
3. Press Memory again to register the station.

When the station is registered, the preset number stops flashing. Repeat this procedure for all of your favorite AM/FM radio stations.

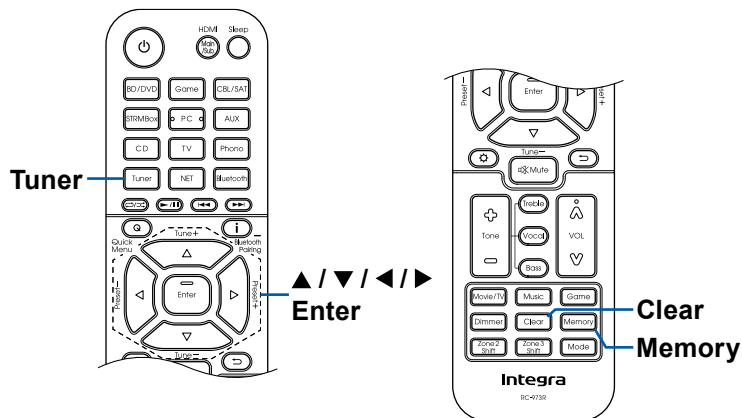

### Selecting a Preset Radio Station

1. Press Tuner.
2. Press the cursors ◀/▶ to select a preset number.

### Deleting a Preset Radio Station

1. Press Tuner.
2. Press the cursors ◀/▶ to select the preset number to delete.
3. After pressing Memory, press Clear while the preset number is blinking, and delete the preset number. When deleted, the number on the display disappears.



## Listening Mode

This unit is equipped with a variety of listening modes, and you can select the optimum listening mode for movies, TV, music, and games by pressing Movie/TV, Music, and Game. (→[p148](#))

- For details of the effects of each listening mode, refer to "Listening Mode Effects" (→[p154](#)).
- For listening modes selectable for each audio format of input signals, refer to "Input Formats and Selectable Listening Modes" (→[p150](#)).

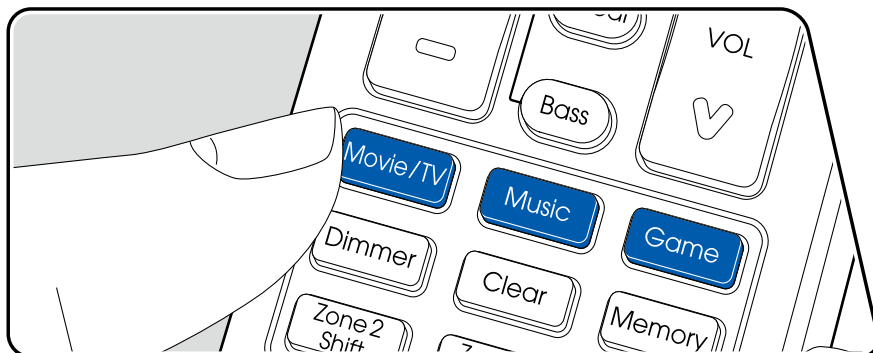

### Selecting a Listening mode

1. Press one from among Movie/TV, Music, and Game during playback.
2. Press the selected button repeatedly to switch the modes displayed on the display of the main unit.

\_\_\_\_\_

DTS

\_\_\_\_\_

- Each of Movie/TV, Music and Game buttons stores the listening mode that was selected last. If content incompatible of the listening mode selected last is played, the most standard listening mode for the content is automatically selected.



## Checking the input format and listening mode

By repeatedly pressing **i** on the remote controller or Info on the main unit, the main unit display changes in the following order:

- The display content for the BLUETOOTH input is different.
- Not all the information is necessarily displayed.

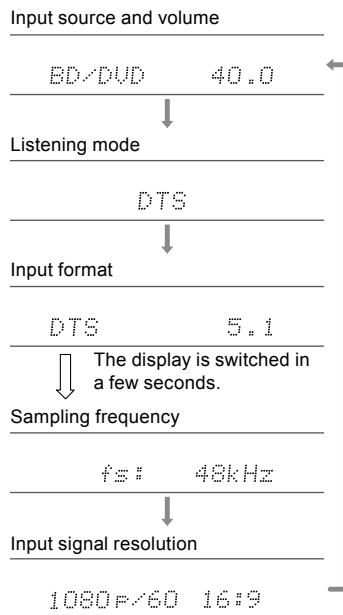

## Quick Menu

### Menu operations

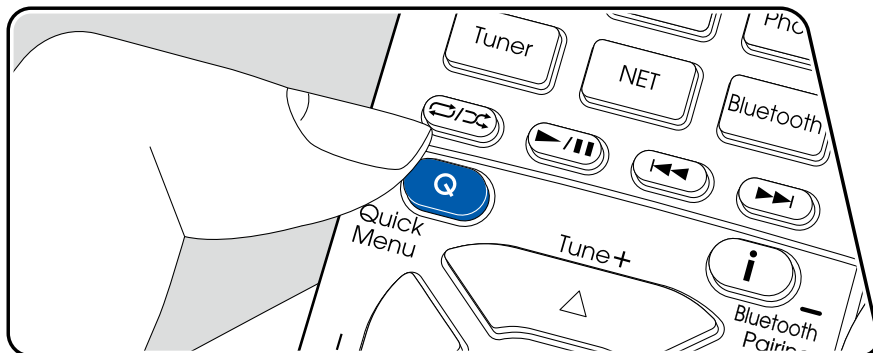

You can quickly adjust the settings you frequently use, such as tone adjustments, etc.

You can make the settings on the TV screen during playback. Press Q on the remote controller to display the Quick Menu.

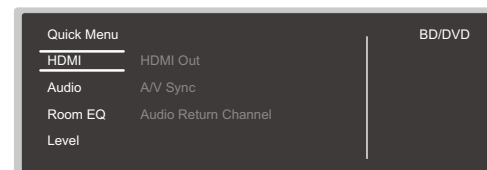

Select the item with the cursors ▲ / ▼ of the remote controller, and press the Enter button to confirm your selection.

Use the cursors to change the settings.

- To return to the previous screen, press ⏪.
- To exit the settings, press Q.



## ■ HDMI

**HDMI Out:** Select the HDMI OUT jack to output video signals from "MAIN", "SUB", and "MAIN+SUB".

**A/V Sync:** If the video is behind the audio, you can delay the audio to offset the gap. The setting can be set for each input.

- It cannot be set if the listening mode is Direct.

**Audio Return Channel:** You can enjoy the sound of the HDMI-connected ARC-compatible TV through the speakers connected to the unit. Select "On" when listening to the audio of TV using the speakers of this unit. Select "Off" when the ARC function is not used.

## ■ Audio

**Music Optimizer:** Improve the quality of the compressed audio. Playback sound of lossy compressed files such as MP3 will be improved. The setting can be set for each input. This works in signals whose sampling frequencies are 48 kHz or less. The setting is not effective in the bitstream signals.

- It cannot be set if the listening mode is Direct.

**Late Night:** Enable small sounds to be easily heard in detail. It is useful when you need to reduce the volume while watching a movie late night.

- This function cannot be used in the following cases.
  - When playing Dolby Digital Plus or Dolby TrueHD with "Loudness Management" set to "Off"
  - When the input signal is DTS:X, and "Dialog Control" is not 0 dB
  - When the input signal is Analog/DSD and the listening mode is Direct

**Zone B:** Select a method of outputting audio to ZONE B from among "Off", "On (A+B)" and "On (B)".

- In the following cases, "Zone B" cannot be selected.
  - When ZONE 2 is On
  - When "2. Speaker" - "Configuration" - "Zone 2 Preout" on the Setup menu is set to an item other than "Zone B". ( →p104)

**Digital Filter:** You can switch the type of digital filter in the AUDIO DAC (digital analog converter). You can choose "Slow" (gives the sound a soft and fluid feel), "Sharp" (gives the sound more structure and firmer feel), "Short" (gives the sound a feeling of a quick start and moving forward), or "AUTO" (auto). The setting can be separately set to each input selector. This can be set when the sampling frequency is 44.1 kHz or more.

## ■ Room EQ

It cannot be set if the listening mode is Direct.

**AccuEQ:** Enable or disable the equalizer function that corrects for sound distortion caused by the acoustic environment of the room.

On (All Ch): EQ that corrects according to the room acoustics acquired with the AccuEQ calibration is applied to all channels.

On (ex. L/R): The same EQ as "On (All Ch)" is applied to speakers other than the Front Speakers. EQ correction for the Front Speakers is turned off.

- The setting can be separately set to each input selector.

**Manual Equalizer:** Select "Preset 1" to "Preset 3" configured in "2. Speaker" - "Equalizer Settings" on the Setup menu. When this is set to "Off", the same sound field setting is applied to all ranges.

**Cinema Filter:** Adjusts the soundtrack with the enhanced high range so that it suits a home theater.

In this function, the following listening modes can be used: Dolby Audio - DD, Dolby Audio - DD+, Dolby Audio - Surr, Dolby Audio - TrueHD, Multichannel, DTS, DTS-ES, DTS 96/24, DTS-HD High Resolution, DTS-HD Master Audio, DTS Neural:X, DTS Express and DSD.

## ■ Level

**Front:** Adjust the speaker level of the front speakers while listening to the sound.

**Center:** Adjust the speaker level of the center speaker while listening to the sound.

**Subwoofer:** Adjust the speaker level of the subwoofer while listening to the sound.

- If you set the unit to the standby mode, the adjustments you made will be restored to the previous statuses.



# Spotify



Use your phone, tablet or computer as a remote control for Spotify.  
Go to [spotify.com/connect](https://spotify.com/connect) to learn how.





## AirPlay®

By connecting this unit to the same network as that of iOS devices such as iPhone®, iPod touch® and iPad®, you can enjoy music files on iOS devices wirelessly.

- Update the OS version on your iOS device to the latest version.
- Depending on the iOS version, operation screens or operation procedures on the iOS device may be different. For details, refer to the operating instructions for the iOS device.

### Basic Operations

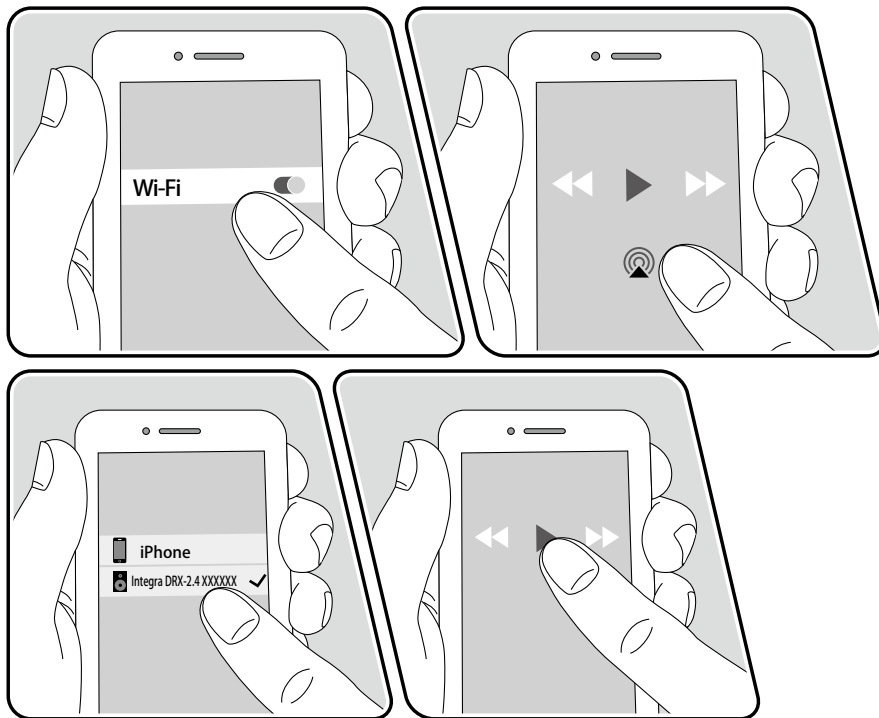

e.g., iOS 10

1. Connect the iOS device to the access point where this unit is connected via network.
2. Tap the AirPlay icon  in the play screen of the music app on an iOS device that supports AirPlay and select this unit from the list of devices displayed.
3. Play the music file on the iOS device.
  - When "6. Hardware" - "Power Management" - "Network Standby" is set to "Off" in the Setup menu, turn this unit on manually, and press the NET button on the remote controller. In the factory default setting, the Network Standby function ( →p121) is set to On.
  - Due to the characteristics of AirPlay wireless technology, the sound produced on this unit may slightly be behind the sound played on the AirPlay-enabled device.

You can also play the music files on a PC with iTunes (Ver. 10.2 or later) equipped. Confirm that this unit and the PC are connected to the same network beforehand. Then, press NET on the remote controller. Next, click the AirPlay icon  in iTunes, select this unit from the displayed devices, and start play of a music file.



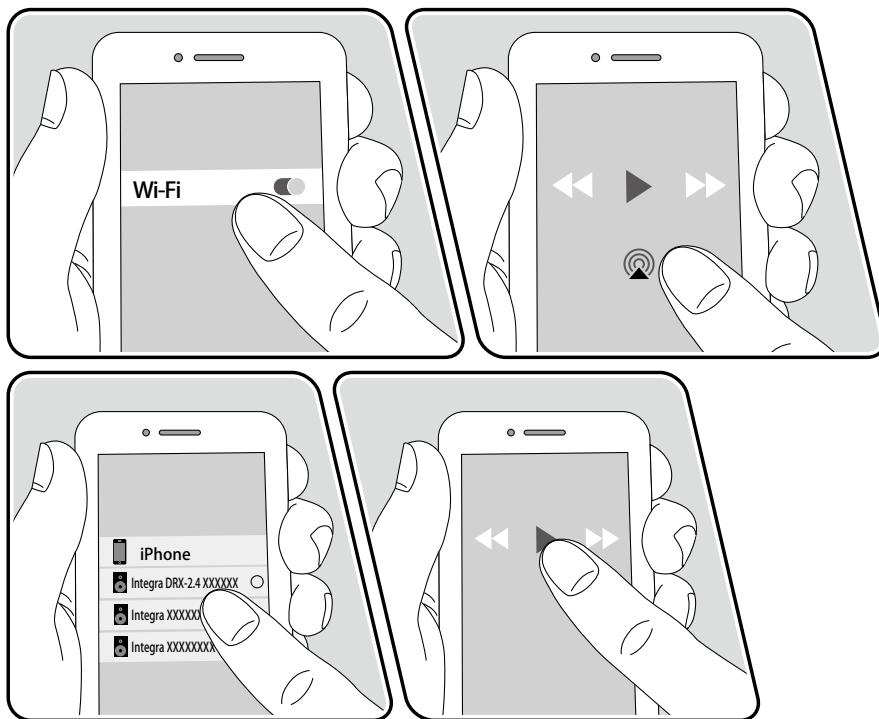

## Playing Back on multiple devices (AirPlay2)



e.g., iOS 11.4

This unit supports AirPlay2. If the version of the iOS device is iOS11.4 or later, you can play the tracks on the iOS device simultaneously on this device and on another device that supports AirPlay2.

1. Connect the iOS device to the access point where this unit is connected via network.
2. Tap the AirPlay icon  on the play screen of the music play application on the iOS device, and select this unit and AirPlay2-supported devices to play from the displayed devices.
  - AirPlay2-supported devices are displayed with white circle on the right side.
  - Multiple AirPlay2-supported devices can be selected.
  - The volume can be adjusted on individual devices.
3. Play the music file on the iOS device.
  - When "6. Hardware" - "Power Management" - "Network Standby" is set to "Off" in the Setup menu, turn this unit on manually, and press the NET button on the remote controller. In the factory default setting, the Network Standby function ( →[p121](#)) is set to On.
  - Due to the characteristics of AirPlay wireless technology, the sound produced on this unit may slightly be behind the sound played on the AirPlay-enabled device.

You can also play the music files on a PC with iTunes (Ver. 12.8 or later) equipped. Confirm that this unit and the PC are connected to the same network beforehand. Then, press NET on the remote controller. Next, click the AirPlay icon  in iTunes, select this unit and AirPlay2-supported devices to play from the displayed devices, and start play of a music file.



## DTS Play-Fi®

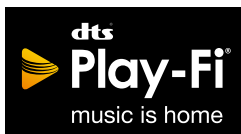

<https://play-fi.com/>

When connecting this unit to the same network as mobile devices, such as a smartphone and tablet, you can enjoy music played on the mobile device wirelessly. Music from a streaming distribution service or music in the music library on a mobile device can be played. This function also supports a playlist on iTunes. Also, connecting multiple speakers supporting DTS Play-Fi on the same network will enable "Group playback" that plays the same music in separate rooms at home. To enjoy this function, download Integra Music Control App (available on iOS or Android™).



## Playing Back

1. Download Integra Music Control App using your mobile device.

[https://integrahometheater.jp/playfi/app\\_i.html](https://integrahometheater.jp/playfi/app_i.html)



2. Connect the mobile device to the network where this unit is connected.
3. Starting up Integra Music Control App will automatically display compatible devices.
4. Select this device from the compatible devices. Then, a list of applications such as a music streaming distribution service is displayed. Select the content to play, and perform operation according to the on-screen instructions.

- When "6. Hardware" - "Power Management" - "Network Standby" is set to "Off" in the Setup menu, turn this unit on manually, and press the NET button on the remote controller. In the factory default setting, the Network Standby function ( →p121) is set to On.
- For detailed operation and FAQ, visit the following URL.  
[https://integrahometheater.jp/playfi/info\\_i.html](https://integrahometheater.jp/playfi/info_i.html)
- To use a music streaming distribution service, user registration may be required.
- This unit does not support the following DTS Play-Fi functions.
  - Spotify
  - Wireless Surround Sound
  - Line In Rebroadcast
  - Internet Radio
- Some of the settings in the "Setup menu" cannot be changed on this unit. To change those settings, cancel the connection of this unit from the application.
- Listening modes cannot be selected during playback.



## Amazon Alexa

Alexa is a cloud-based voice service developed by Amazon. When this unit is registered with an Amazon account, you can use a terminal with Amazon Alexa (an Amazon Echo, etc.) or Amazon Alexa App (available on iOS and Android™) to perform operations such as adjusting the volume of this unit or playing music using voice commands.

- You need an Amazon account to use Amazon Alexa. For more information, see the Amazon website.

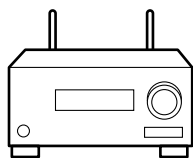
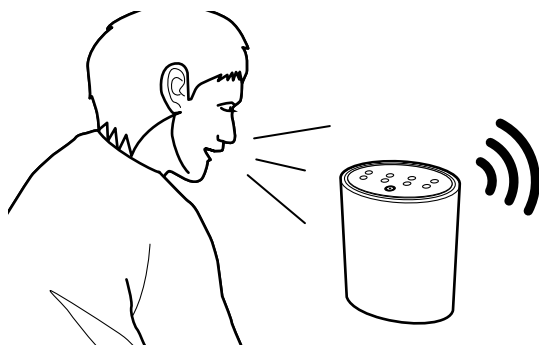

## Registering this unit with an Amazon account

- Register with the Amazon account on Integra Control Pro. This cannot be set with operations on this unit. Refer to "Integra Control Pro" (→[p132](#)) for information about the app.
- Start Integra Control Pro and tap the unit when displayed.
- Tap "NET" or "NETWORK" at the top of the Integra Control Pro screen, and after switching to the network menu, tap the "amazon alexa" icon.
  - If the login screen is not displayed but an update or installation screen is displayed instead, perform the update or installation according to the on-screen instructions.

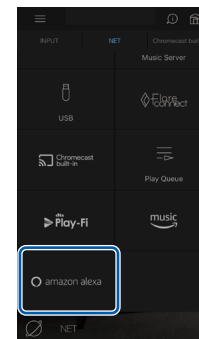

Available services may differ depending on your area.

- Tap "Start Setup", and in the Setup screen, select the language and register the device name. Select the same language as the one you have selected for your other terminals with Amazon Alexa (an Amazon Echo, etc.). For the device name, use one that can easily be called up vocally. For example: Speaker
- Tap "Next" to display the Amazon Alexa screen.
- Follow the on screen instructions to enter the Amazon account information, such as your email address and password, to log into Amazon (\*1). After logging in, tap "Allow" and register this unit with an Amazon account. (\*1) Log in using the same account as other terminals with Amazon Alexa.



7. When registration is finished, the screen returns to the one for Integra Control Pro. Follow the on screen instructions and talk to the terminal with Amazon Alexa (an Amazon Echo, etc.), and confirm that you can use voice commands.

For example: "Alexa, raise the volume of the speaker (\*2)"  
 "Alexa, play music from the speaker (\*2)"

(\*2) Use the device name you registered in Step 4 when talking.

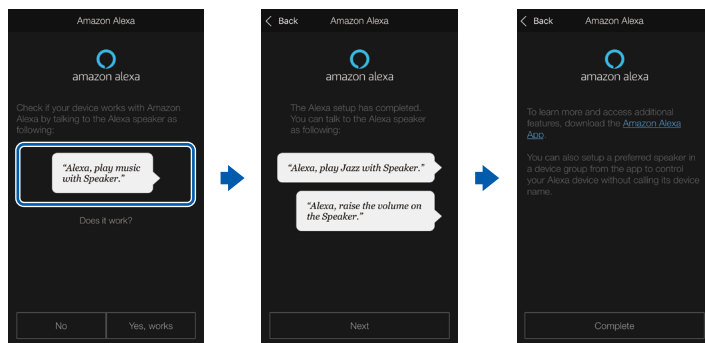

## Operating this unit

You can use voice commands to adjust the volume on this unit, start and stop music, and skip music up or down.

1. With the unit on, speak at the terminal with Amazon Alexa (an Amazon Echo, etc.). When using the Amazon Alexa app, after starting the app, tap the Alexa logo and speak at the mobile device.

For example: "Alexa, raise the volume of the speaker (\*3)"  
 "Alexa, play music from the speaker (\*3)"

(\*3) Use the device name you registered in Step 4 of "Registering this unit with an Amazon account" when talking.

- Refer to the website for details about voice commands. ([Click here](#) 📄)
- It is not possible to turn the unit on or off, or to switch the listening mode.
- Refer to the Amazon websites for information about operation of the Amazon Alexa app.



## Amazon Music



Registering this unit with Amazon Music allows you to enjoy the music distribution service provided by Amazon.

- To play Amazon Music, you need to have your Amazon account and sign up for Amazon Prime or Amazon Music Unlimited. For more information, see the Amazon website.

Amazon Music is now available in several countries. If Amazon Music is not available in your country, please visit <https://music.amazon.com/> for more info.

### Registering This Unit with Amazon Music

- Register with the Amazon account on Integra Control Pro. This cannot be set with operations on this unit. Refer to "Integra Control Pro" (→p132) for information about the app.
- Start Integra Control Pro and tap the unit when displayed.
- Tap "NET" or "NETWORK" on the upper part of the Integra Control Pro's screen to switch to the network menu. Then tap the "Amazon Music" icon to display the login screen of Amazon Music. (Depending on the model, the icon names may be different.)
  - If the login screen is not displayed but an update or installation screen is displayed instead, perform the update or installation according to the on-screen instructions.

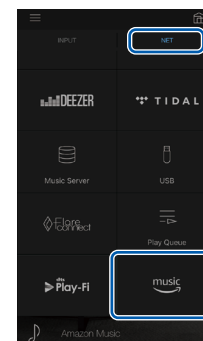

Available services may differ depending on your area.

- Enter the Amazon account information such as email address and password to log in to Amazon. When the login is successful and this unit is registered, the Amazon Music menu is displayed. For playback, proceed to step 3 in the next section.



## Playing Amazon Music using the Integra Control Pro

---

1. Start up Integra Control Pro. This unit is automatically displayed after startup. Then, tap and select this unit displayed.
2. Tap "NET" or "NETWORK" on the upper part of the screen to switch to the network screen. Then tap the "Amazon Music" icon.
3. Select the content to play from the menu screen of Amazon Music to start playback.

## Playing Amazon Music using the remote controller

---

1. Switch the input on the TV to the input connected to the unit.
2. Pressing NET will display the Network Functions list screen on the TV.
3. Select "Amazon Music" with the cursors and press Enter to confirm.
4. Select the content to play from the menu screen of Amazon Music to start playback.



## Connecting the Sonos System for Playback



Connecting this unit and Sonos Connect allows you to send the music or music sources on the Sonos App to this unit. Through Sonos Connect, you can play this unit with the same group of another Sonos device on the network or can play only on this unit. Also, if you start to play music from Sonos App, this unit is automatically turned on and the link function to switch input works.

- When "6. Hardware" - "Power Management" - "Network Standby" is set to "Off" in the Setup menu, turn this unit on manually, and press the NET button on the remote controller. In the factory default setting, the Network Standby function (→p121) is set to On.
- You can register a maximum of 2 Sonos Connect.

### Necessary Equipment

- Sonos Connect
- RCA audio cable (supplied with Sonos Connect)

## How to Connect This Unit and Sonos Connect

1. Connect the Sonos Connect to the AUDIO IN jack of this unit with the RCA audio cable supplied with the Sonos Connect. Any input jacks other than the PHONO jack can be used.
  - A digital cable can also be connected. For details, refer to the instruction manual of Sonos.
  - You can change the name of the input selector displayed on this unit to easier-to-understand name. For example, the input connected to Sonos Connect can be changed from "CD" (or another input selector name) to "SONOS". Press the ⚙ button on the remote controller, select "4. Source" - "Name Edit" and then change the name.

## Setting Up

A setup is required to play Sonos on this unit. Make the setting according to the following procedure.

1. Press the ⚙ button on the remote controller, select "6. Hardware" - "Works with SONOS", and press the Enter button.
2. Select the following items with the cursors ▲ / ▼ and set each item.

#### Input Selector:

Enable the interlocking function with the Sonos Connect. With the cursors ◀ / ▶, select the input selector to which the Sonos Connect is connected.

#### Connected Device:

Press the Enter button to display Sonos devices connected to the same network as the network of this unit. Select the Sonos Connect connected to the unit and press the Enter button.

- Products (e.g. Play:3 unequipped with an output terminal) other than the Sonos Connect are also displayed in the device list and selectable. In that case, when playback on the Sonos side starts, the input is switched, however, audio is not output. Select the room name of the connected Sonos Connect.
- Up to 32 devices can be displayed on the Sonos product list screen. If you





cannot find the Sonos Connect to be interlocked, return to the previous screen, turn off the product you do not want to interlock, and try again.

### Output Zone:

With the cursors ◀/▶, select the ZONE where you want to listen to the music.

"Main": Outputs audio only to the main room (where this unit is located).

"Zone 2": Outputs audio only to the separate room (ZONE 2).

"Main/Zone 2": Outputs audio to both the main room and separate room.

### Preset Volume:

You can set the volume that Sonos Connect will be played at in the main room (where this unit is located) beforehand. Select a value from "Last" (Volume level before entering standby mode), "Min", "0.5" to "99.5" and "Max".

- When making the setting for the second unit, press the cursor ▼ several times to move to the next page, and change the menu from "SONOS-1" to "SONOS-2".

## Playing Sonos on This Unit

---

1. Select desired tracks using Sonos App and send the tracks to the room where this unit is located (or to the group). It is recommended to give an easy-to-remember name to the combination of this unit and Sonos Connect, such as TV Room or Living Room where this unit is located.
- If the input selector of this unit is not automatically switched even after the start of music playback, stop the playback once and start again.
  - When the "Volume Pass Through" mode has been selected with the Sonos App settings, you can use the Sonos App to control the volume of this unit.
    - \* You cannot use the "Preset Volume" function when the "Volume Pass Through" mode has been selected.



## Internet Radio

By connecting this unit to an Internet-connected network, you can enjoy Internet radio services such as TuneIn Radio.

- To play Internet radio services, the network needs to be connected to the Internet.
- Depending on the Internet radio service, a user registration may be required on your PC beforehand. For details of each service, visit the website of each service.

## Playing Back

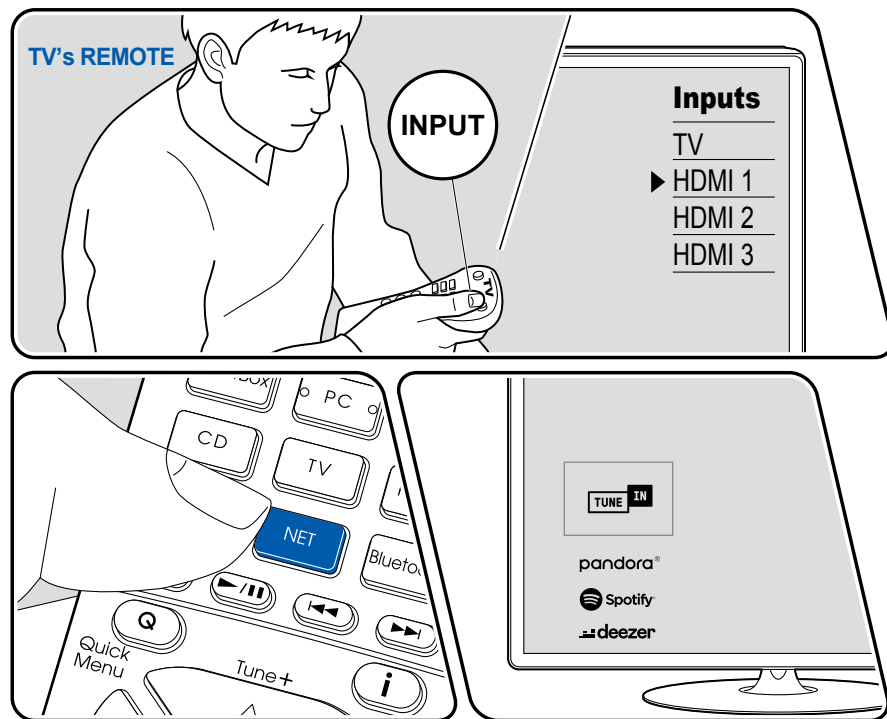

The illustration shows an image.

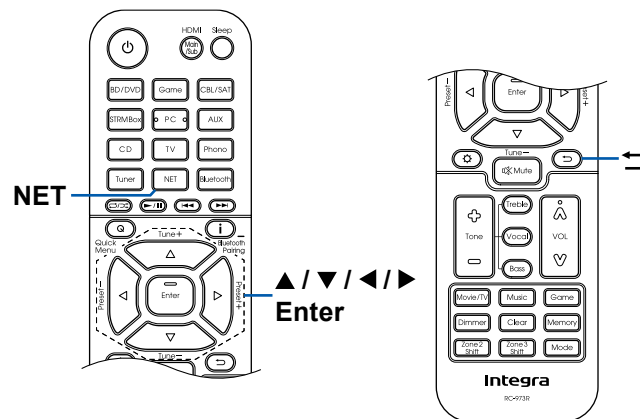

Perform the following procedure when this unit is on.

1. Switch the input on the TV to the input connected to the unit.
2. Pressing NET will display the Network Functions list screen on the TV.
3. Select your preferred Internet radio service using cursor, and press Enter to confirm the selection.
4. Following the on-screen instructions, select a radio station and program using cursor, and then press Enter to play.
  - To return to the previous screen, press ⏪.



## Internet Radio Service Menu

You can bookmark specific stations, or delete stations that have been bookmarked. The displayed menu varies according to the service being selected.

The menu icon  is displayed while a station is being played. When only this icon is displayed, pressing Enter will display the menu on the screen. When multiple icons are displayed, select the  icon with the cursor, and press Enter.

## Regarding the TuneIn Radio Account

If you create an account on the TuneIn Radio website (tunein.com), and log in it from this unit, your favorite radio stations or programs you have followed on the website are automatically added to your "My Presets" on this unit. "My Presets" is displayed on the next level in the hierarchical structure of TuneIn Radio. To display a radio station added to "My Presets", you need log into TuneIn Radio from the unit. To log in, select "Login" - "I have a TuneIn account" in the "TuneIn Radio" top list on the unit, and then enter your user name and password.

- If you select "Login" on this unit, a registration code is displayed. By using this code, you can associate the device on the My Page section of the TuneIn Radio website so that you can log in from "Login" - "Login with a registration code" without entering the user name and password.



## Multi-zone

You can enjoy 2 ch audio in the separate room (ZONE 2) while performing playback in the main room (where this unit is located). The same source can be played back in the main room and ZONE 2 simultaneously. Also, different sources can be played back in both rooms. For the "NET" or "BLUETOOTH" input selector, you can select only the same source for the main room and separate room. If you select "NET" in the main room and then select "BLUETOOTH" in the separate room, the main room setting switches to "BLUETOOTH". You cannot select different stations of AM/FM broadcasts for the main room and separate room. Using Integra Control Pro ( →[p132](#)) is convenient for operations of multi-zone playback. You can use it on mobile devices, such as a smartphone and tablet to which Integra Control Pro (available on iOS or Android™) has been downloaded.



**Playing Back** ( →[p85](#))



# Playing Back

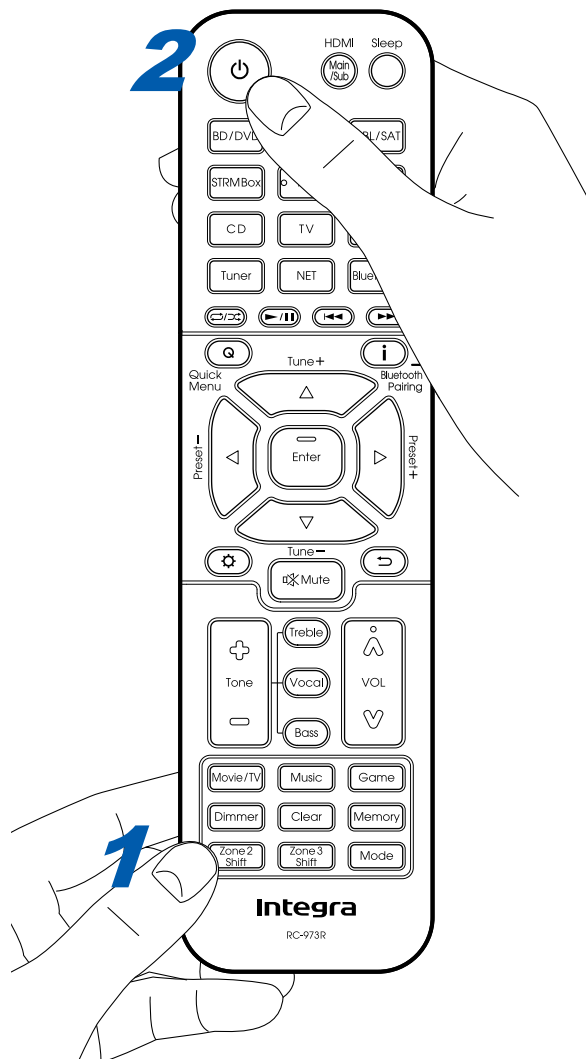

In remote controller operation, while pressing and holding the Zone 2 Shift button, press other buttons for operation.

1. While pressing and holding the Zone 2 Shift button on the remote controller, point the remote controller at this unit and press .
  - "Z2" on the display of the main unit lights up.



2. While pressing and holding the Zone 2 Shift button on the remote controller, press the input selector of the input source you want to play in the separate room. To control on the main unit, press the Zone 2 button, and then within 8 seconds, press the input selector button of the input to be played in the separate room. To play the same source in the main room and separate room, press the Zone 2 button of the main unit twice.
3. When using the ZONE 2 PRE/LINE OUT connection, adjust the sound volume on the integrated amplifier in the separate room. For the ZONE speaker output, while pressing and holding the Zone 2 Shift button on the remote controller, adjust the volume with the volume button. To do this on the main unit, press Zone 2 Level / button to adjust.
  - When connecting an Integrated Amplifier that does not have a volume control, in the Setup menu, set "7. Multi Zone" - "Zone 2" - "Output Level" to ( [→p125](#) ) "Variable (Default Value: Fixed)". If you do not set this, the volume output will be very loud and there is a danger of damage to the Integrated Amplifier, speakers, etc. When connecting an Integrated Amplifier that has a volume control, leave this as "Fixed".
  - If you turn the unit to standby during multi-zone playback, the Z2 indicator is dimmed, and the playback mode is switched to playback in a separate room only. Setting ZONE 2 to on while the unit is in standby also switches the playback mode to playback in the separate room only.
  - When audio is being output from the ZONE SPEAKER, surround back speakers or height speakers cannot play audio.
  - The audio from externally connected AV components can be output to ZONE 2 only when the audio is analog or 2 ch PCM signal. When the AV component is connected to this unit with an HDMI cable, digital coaxial cable or digital optical cable, change the audio output of the AV component to the PCM output.



- When video and audio via HDMI input are output to ZONE 2, set "1. Input/Output Assign" - "TV Out / OSD" - "Zone 2 HDMI" (→p101) to "Use" on the Setup menu.
- DSD audio signals cannot be output to ZONE 2 with the "NET" input selector.
- If ZONE 2 is on, power consumption during standby will increase.

**To disable the function:** While pressing and holding the Zone 2 Shift button on the remote controller, press . Alternatively press Off on the main unit.



## Playing different audio and video

### Displaying Your Favorite Video on TV While Playing Music

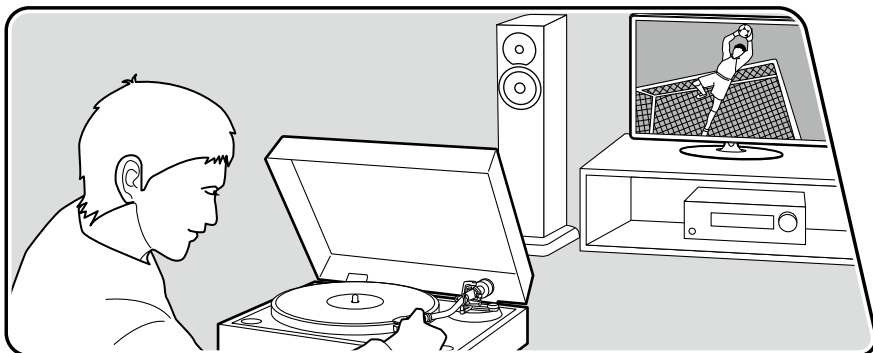

The illustration shows an image.

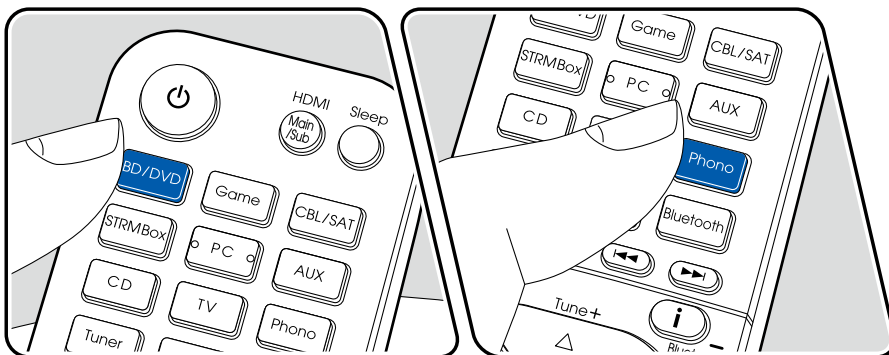

While listening to the music from a CD or BLUETOOTH enabled device, you can display video on TV from an AV component such as a Blu-ray Disc player.

- For audio playback, you can select an input selector to which video input is not assigned, such as "CD", "PHONO", "TUNER", "NET" and "BLUETOOTH".
- When "OSD Language" ( → [p101](#)) is set to Chinese, the audio from "NET" and "BLUETOOTH" cannot be played.

Perform the following procedure when this unit is on.

1. Switch the input on the TV to the input connected to the unit.
2. Press an input selector such as BD/DVD button connected to the AV component of which the video is to be displayed on TV.
  - This operation is not necessary if the same input selector has been selected in the previous operation.
3. Press an input selector of the audio you want to play, such as the CD or Bluetooth button and perform playback operation.
4. Perform the playback operation of the AV component such as a Blu-ray Disc player. To play the audio of NET or BLUETOOTH, the following step 5 operation is required.
5. To play the audio of NET or BLUETOOTH, press the Mode button to switch the TV display from the NET or BLOOTOOTH playback screen to the video of the AV component. Pressing the Mode button again will return to the NET or BLOOTOOTH playback screen.
  - When the TV display is switched to the video of the AV component, the playback screen of NET or BLUETOOTH is displayed on the corner of the screen as Mini Player. The setting for Mini Player can be changed on the Setup Menu so that it automatically turns off in 30 seconds after displayed. ("Mini Player OSD" ( → [p102](#)))

**Setting the video source to be displayed on TV beforehand:** When playing the audio of "TUNER", "NET" and "BLUETOOTH", you can set the input selector to be displayed on TV beforehand using "Video Select" ( → [p112](#)) on the Setup Menu. If a value other than "Last" is set, step 2 in the operation procedure is not required.



## USB Storage Device

You can play music files stored on a USB storage device.

### Supported Audio Formats

#### MP3 (.mp3)

- MPEG-1/MPEG-2 Audio Layer 3/44.1 kHz, 48 kHz/Between 8 kbps and 320 kbps, and VBR

#### WMA (.wma)

- 44.1 kHz, 48 kHz/Between 5 kbps and 320 kbps, and VBR
- WMA Pro/Voice/WMA Lossless formats are not supported.

#### WAV (.wav)

WAV files contain uncompressed PCM digital audio.

- 44.1 kHz, 48 kHz, 88.2 kHz, 96 kHz, 176.4 kHz, 192 kHz/8 bit, 16 bit, 24 bit

#### AIFF (.aiff/.aif)

AIFF files contain uncompressed PCM digital audio.

- 44.1 kHz, 48 kHz, 88.2 kHz, 96 kHz, 176.4 kHz, 192 kHz/8 bit, 16 bit, 24 bit

#### AAC (.aac/.m4a/.mp4/.3gp/.3g2)

- MPEG-2/MPEG-4 Audio/44.1 kHz, 48 kHz, 88.2 kHz, 96 kHz/Between 8 kbps and 320 kbps, and VBR

#### FLAC (.flac)

- 44.1 kHz, 48 kHz, 88.2 kHz, 96 kHz, 176.4 kHz, 192 kHz/8 bit, 16 bit, 24 bit

#### LPCM (Linear PCM)

- 44.1 kHz, 48 kHz/16 bit

#### Apple Lossless (.m4a/.mp4)

- 44.1 kHz, 48 kHz, 88.2 kHz, 96 kHz, 176.4 kHz, 192 kHz/16 bit, 24 bit

#### DSD (.dsf/.dff)

- DSF/DSDIFF/2.8 MHz, 5.6 MHz, 11.2 MHz

### USB Storage Device Requirements

- This unit can use USB storage devices that comply with the USB mass storage class standard. Also the format of USB storage devices supports FAT16 or FAT32 file system format.
- If the USB storage device has been partitioned, each section will be treated as an independent device.
- Up to 20,000 tracks per folder are supported, and folders can be nested up to 16 levels deep.
- USB hubs and USB storage devices with hub functions are not supported. Do not connect these devices to the unit.
- If an AC adapter is supplied with the USB storage device, connect the AC adapter, and use it with a household outlet.
- USB storage devices with security functions are not supported on this unit.
- Media inserted to the USB card reader may not be available in this function. Furthermore, depending on the USB storage device, proper reading of the contents may not be possible.
- In use of a USB storage device, our company accepts no responsibility whatsoever for the loss or modification of data stored on a USB storage device, or malfunction of the USB storage device. We recommend that you back up the data stored on a USB storage device before using it with this unit.
- Note that operation is not always guaranteed for all USB storage devices.

**Playing music files saved on a USB storage device ( →[p89](#))**





## Playing music files saved on a USB storage device

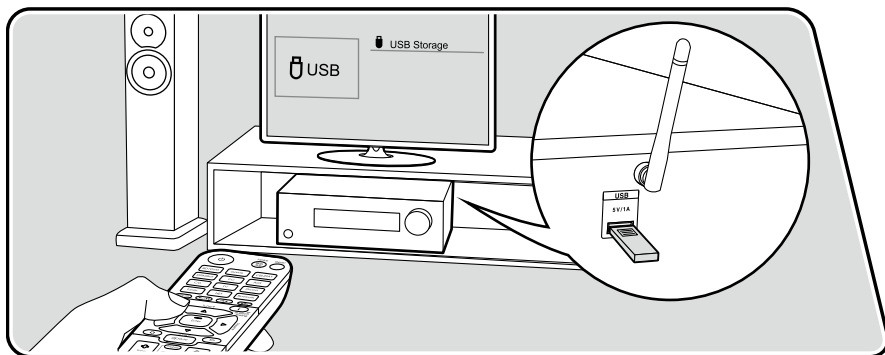

Perform the following procedure when this unit is on.

1. Switch the input on the TV to the input connected to the unit.
2. Plug your USB storage device containing music files into the USB port of this unit's rear panel.
3. Press NET to display the network service list screen.
4. Select "USB" with the cursors, and then press Enter.
  - If the "USB" indicator blinks on the display, check whether the USB storage device is plugged in properly.
  - Do not unplug the USB storage device while "Connecting..." is being displayed on the display. This may cause data corruption or malfunction.
5. Press Enter on the next screen again. The list of folders and music files on the USB storage device is displayed. Select the folder with the cursors, and press Enter to confirm your selection.
6. Select the music file with the cursors, and then press Enter to start playback.

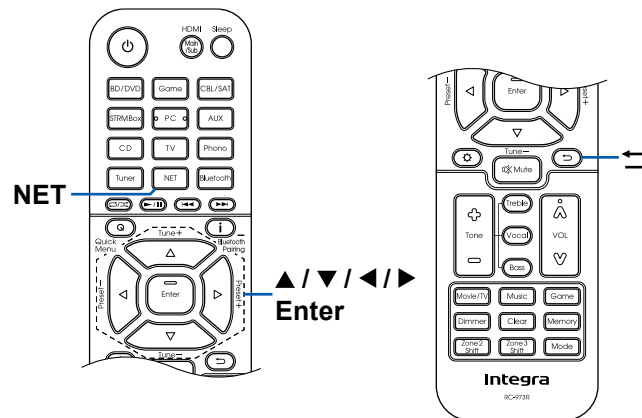

- To return to the previous screen, press ↶.
- Characters that cannot be displayed on this unit appear with "\*".
- The USB port of this unit complies with the USB 2.0 standard. The transfer speed may be insufficient for some content you play, and sound interruptions, etc. may occur.
- When playing files recorded with VBR (Variable bit-rate), the playback time may not be displayed correctly.



- This unit supports the gapless playback of the USB storage device in the following conditions.  
When continuously playing WAV, FLAC and Apple Lossless files with the same format, sampling frequency, the number of channels and quantization bit rate.
- To display an album title, artist name and album art of a file in WAV format, make the folder structure and file names as shown below when saving music files. The album art can be displayed by saving a .jpg file to display on the screen in the folder of bottom level. Note that a large volume of .jpg file may take time to be displayed, or may not be displayed.

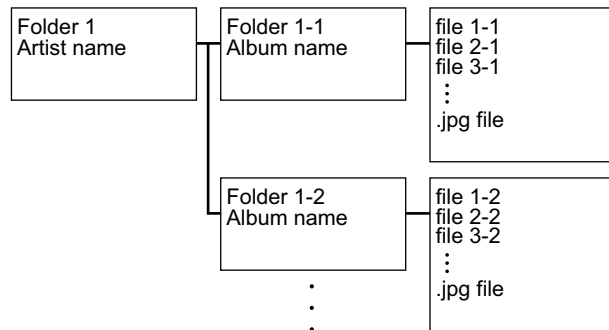

## Music Server

Streaming play of music files stored on PCs or NAS devices connected to the same network as this unit is supported.

- The network servers this unit is compatible with are those PCs with players installed that have the server functionality of Windows Media® Player 12, or NAS that are compatible with home network functionality. When using Windows Media® Player 12, you need to make the settings beforehand. Note that with PCs, only music files registered in the library of Windows Media® Player can be played.

### Supported Audio Formats

#### MP3 (.mp3)

- MPEG-1/MPEG-2 Audio Layer 3/44.1 kHz, 48 kHz/Between 8 kbps and 320 kbps, and VBR

#### WMA (.wma)

- 44.1 kHz, 48 kHz/Between 5 kbps and 320 kbps, and VBR
- WMA Pro/Voice/WMA Lossless formats are not supported.

#### WAV (.wav)

WAV files contain uncompressed PCM digital audio.

- 44.1 kHz, 48 kHz, 88.2 kHz, 96 kHz, 176.4 kHz, 192 kHz/ 8 bit, 16 bit, 24 bit

#### AIFF (.aiff/.aif)

AIFF files contain uncompressed PCM digital audio.

- 44.1 kHz, 48 kHz, 88.2 kHz, 96 kHz, 176.4 kHz, 192 kHz/8 bit, 16 bit, 24 bit

#### AAC (.aac/.m4a/.mp4/.3gp/.3g2)

- MPEG-2/MPEG-4 Audio/44.1 kHz, 48 kHz, 88.2 kHz, 96 kHz/Between 8 kbps and 320 kbps, and VBR

#### FLAC (.flac)

- 44.1 kHz, 48 kHz, 88.2 kHz, 96 kHz, 176.4 kHz, 192 kHz/ 8 bit, 16 bit, 24 bit

#### LPCM (Linear PCM)

- 44.1 kHz, 48 kHz/16 bit

#### Apple Lossless (.m4a/.mp4)

- 44.1 kHz, 48 kHz, 88.2 kHz, 96 kHz/16 bit, 24 bit

#### DSD (.dsf/.dff)

- DSF/DSDIFF/2.8 MHz, 5.6 MHz, 11.2 MHz

### Windows Media® Player 12 settings

1. Turn on your PC, and start Windows Media® Player 12.
2. In the "Stream" menu, select "Turn on media streaming" to display a dialog box.
  - If the media streaming is already turned on, select "More streaming options..." in the "Stream" menu to display the list of playback devices in the network, and then go to step 4.
3. Click "Turn on media streaming" to display the list of playback devices in the network.
4. Select this unit in "Media streaming options" and check that it is set to "Allow".
5. Click "OK" to close the dialog.
6. Open the "Stream" menu and confirm that "Allow remote control of my Player..." is checked.

**Playing Back** ( → [p92](#) )



# Playing Back

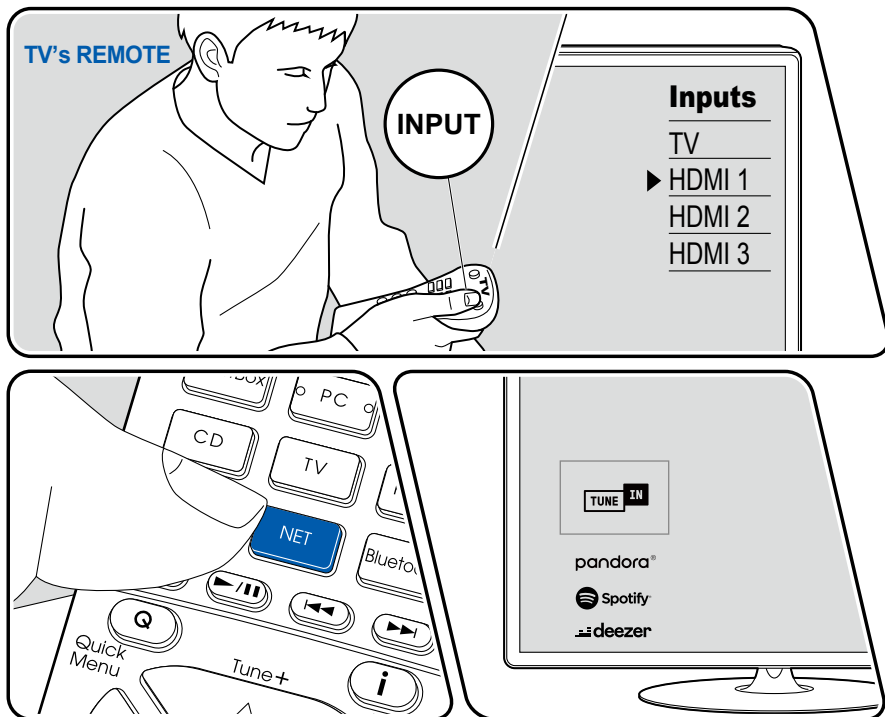

The illustration shows an image.

Perform the following procedure when this unit is on.

1. Switch the input on the TV to the input connected to the unit.
2. Start the server (Windows Media® Player 12 or NAS device) containing the music files to play.
3. Make sure that the PC or NAS is properly connected to the same network as this unit.
4. Press NET to display the network service list screen.
  - If the "NET" indicator on the display blinks, the unit is not properly connected to the network. Check the connection.

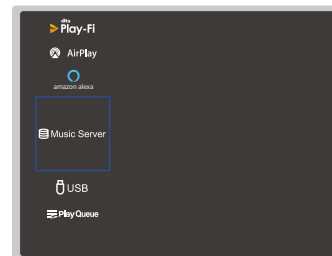

5. With the cursors, select "Music Server", and then press Enter.

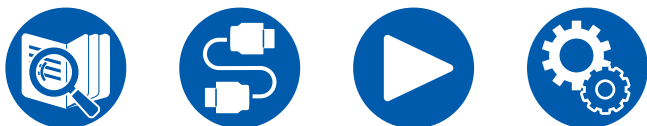
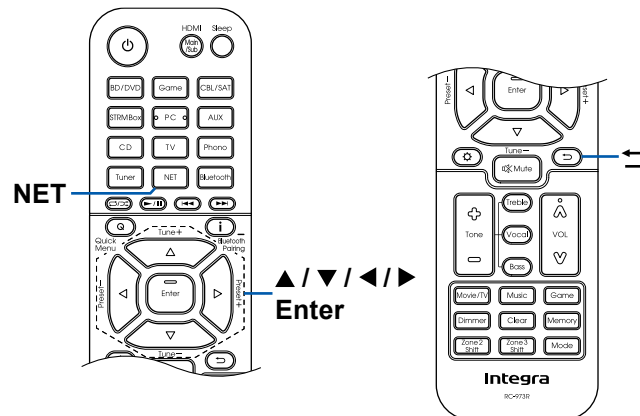

6. Select the target server with the cursors, and press Enter to display the items list screen.
  - This unit cannot access pictures and videos stored on servers.
  - Depending on the server sharing settings, contents stored on the server may not be displayed.
7. With the cursors, select the music file to play, and then press Enter to start playback.
  - If "No Item." is displayed on the screen, check whether the network is properly connected.
  - To return to the previous screen, press ↩.
  - When playing files recorded with VBR (Variable bit-rate), the playback time may not be displayed correctly.
  - For music files on a server, up to 20,000 tracks per folder are supported, and folders can be nested up to 16 levels deep.
  - Depending on the type of media server, the unit may not recognize it, or may not be able to play its music files.

## Searching music files to select

If the server you use supports search functions, the following search function can be used.

Perform the following procedure with available servers displayed using Music Server.

1. With ▲ / ▼, select the server containing music files you want to play, and select Enter.
2. With ▲ / ▼, select the Search folder, and press Enter. The Search folder contains the following three folders.
  - "Search by Artist": Select this when searching by artist name.
  - "Search by Album": Select this when searching by album title.
  - "Search by Track": Select this when searching by track title.
3. With ▲ / ▼, select the folder, and press Enter.
4. Input a character string to search for, and press Enter. Then, the search result is displayed.
5. With ▲ / ▼, select the music files to play, and select Enter.

## Controlling Remote Playback from a PC

You can use this unit to play music files stored on your PC by operating the PC in your home network. The unit supports remote playback via Windows Media® Player 12. To use the remote playback function of this unit with Windows Media® Player 12, it must be configured beforehand. ( →p91)

### Remote playback

1. Turn on the power of the unit.
  2. Turn on your PC, and start Windows Media® Player 12.
  3. Select and right-click the music file to play with Windows Media® Player 12.
    - To remotely play a music file on another server, open the target server from "Other Libraries", and select the music file to play.
  4. Select this unit in "Play to" to open the "Play to" window of Windows Media® Player 12, and start playback on this unit.
    - If your PC is running on Windows® 8.1, click "Play to", and select this unit. If your PC is running on Windows® 10, click "Cast to Device", and select this unit. Operations during remote playback are possible from the "Play to" window on the PC. The playback screen is displayed on the HDMI-connected TV.
  5. Adjust the volume using the volume bar on the "Play to" window.
    - Sometimes, the volume displayed on the remote playback window may differ from the volume displayed on the display of this unit.
    - When the volume is changed on this unit, the value is not reflected in the "Play to" window.
    - This unit cannot play music files remotely in the following conditions.
      - It is using a network service.
      - It is playing a music file on a USB storage device.
- Remote play of FLAC and DSD is not supported.  
 • Remote playback does not support the gapless playback.



# Play Queue



When downloading Integra Control Pro (available on iOS or Android™) to mobile devices, such as a smartphone and tablet, you can save your favorite playlist (Play Queue information) among music files stored in the USB storage device connected to this unit and music files stored in PC or NAS connected to the same network as this unit, and you can play the music on the playlist. The Play Queue information is effective until the power cord of this unit is removed from the outlet. Refer to "Integra Control Pro" ( →p132) for information about the app.

## Adding Play Queue Information

1. Select the "INPUT" input on the application screen, and tap the "USB" icon. Or, select the "NET" input, and tap the "USB" icon or "Music Server" icon. (Depending on the model, the icon names may be different.)

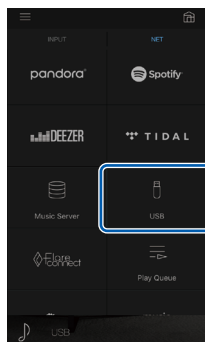

2. Tapping the "+" icon of the track you want to add will open the pop-up to add the Play Queue information.

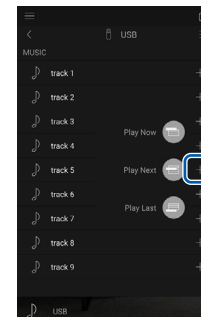

3. Touch the "Play Now" (⏮️), "Play Next" (⏪️) or "Play Last" (⏩️) icon to add the track to Play Queue.
  - If there are no tracks on the Play Queue list, only "Play Now" (⏮️) is displayed.

## Sort and Delete

1. Select the "NET" input, tap the "Play Queue" icon, and enter the Play Queue service screen.

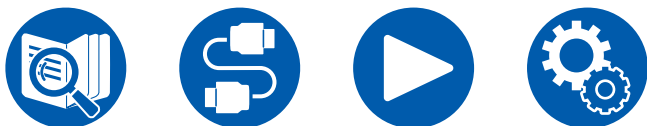
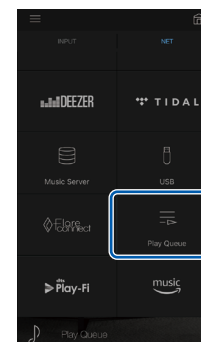

2. Tap the "☰" icon of the track to sort, and drag the icon to the destination.

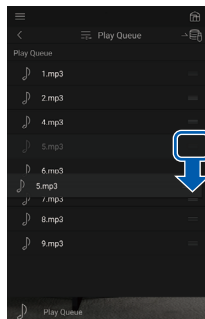

3. To delete a track, slide the track to the left until the trash icon changes to "🗑️". If the device is on iOS, slide the "☰" icon to the left. Releasing your finger will delete the track from Play Queue.

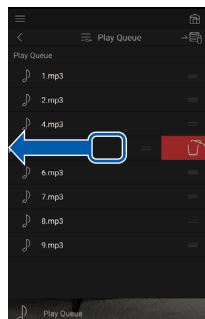

## Playing Back

Playback starts when you select "Play Now" for Play Queue addition, or select the track in the Play Queue service screen.



## Connecting a transmitter for playback

When you connect wireless headphones or a wireless speaker transmitter to the ZONE B LINE OUT terminal on this unit, you can play back the same source through the wireless headphones or wireless speakers as in the main room.

### Connections

1. Use an analog audio cable to connect the ZONE B LINE OUT terminal on this unit to the input terminal on the transmitter.

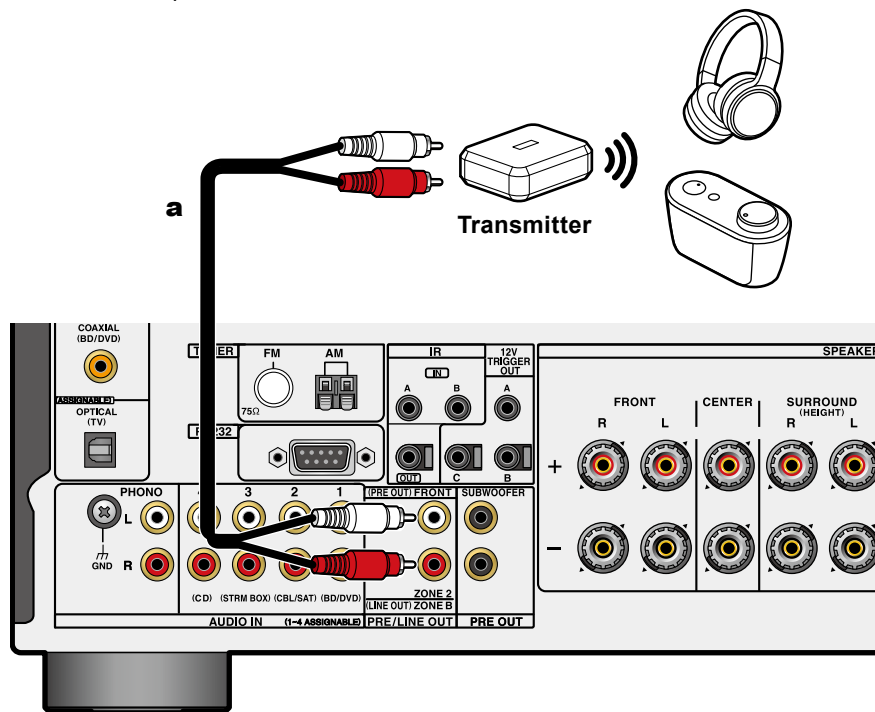

**a** Analog audio cable



### Setting Up

1. Press on the remote controller, and set "2. Speaker" - "Configuration" - "Zone 2 Preout" to "Zone B". ( →[p104](#))

### Playing Back

1. Press the Q button on the remote controller and select "Audio" - "Zone B".
  - In the following cases, "Zone B" cannot be selected.
    - When ZONE 2 is On
    - When "2. Speaker" - "Configuration" - "Zone 2 Preout" on the Setup menu is set to an item other than "Zone B". ( →[p104](#))
2. Select the audio output destination.
  - Off:** Outputs audio only from ZONE A. "A" on the display of the main unit lights up.
  - On (A+B):** Outputs audio from both ZONE A and ZONE B. "A" and "B" on the display of the main unit light up.
  - On (B):** Outputs audio only from ZONE B. "B" on the display of the main unit lights up.



3. Start play on the AV component.
4. Adjust the volume on the transmitter, etc., in ZONE B.
  - When "Zone 2 Preout" is set to "Zone B", and "Audio" - "Zone B" on the Quick Menu is set to "On (A+B)", the ZONE A output is set as below.
    - Sound quality cannot be adjusted.
    - There will be no effect for the surround back speakers from "2.Speaker" - "Distance" ( →[p106](#)) in the Setup menu.
  - If "On (A+B)" is selected as an audio output destination, you can select only the "Stereo" listening mode for ZONE A when using the 2.1 ch speaker layout. When using a speaker layout of 3.1 ch or more, you can select only the "AllCh Stereo" listening mode.





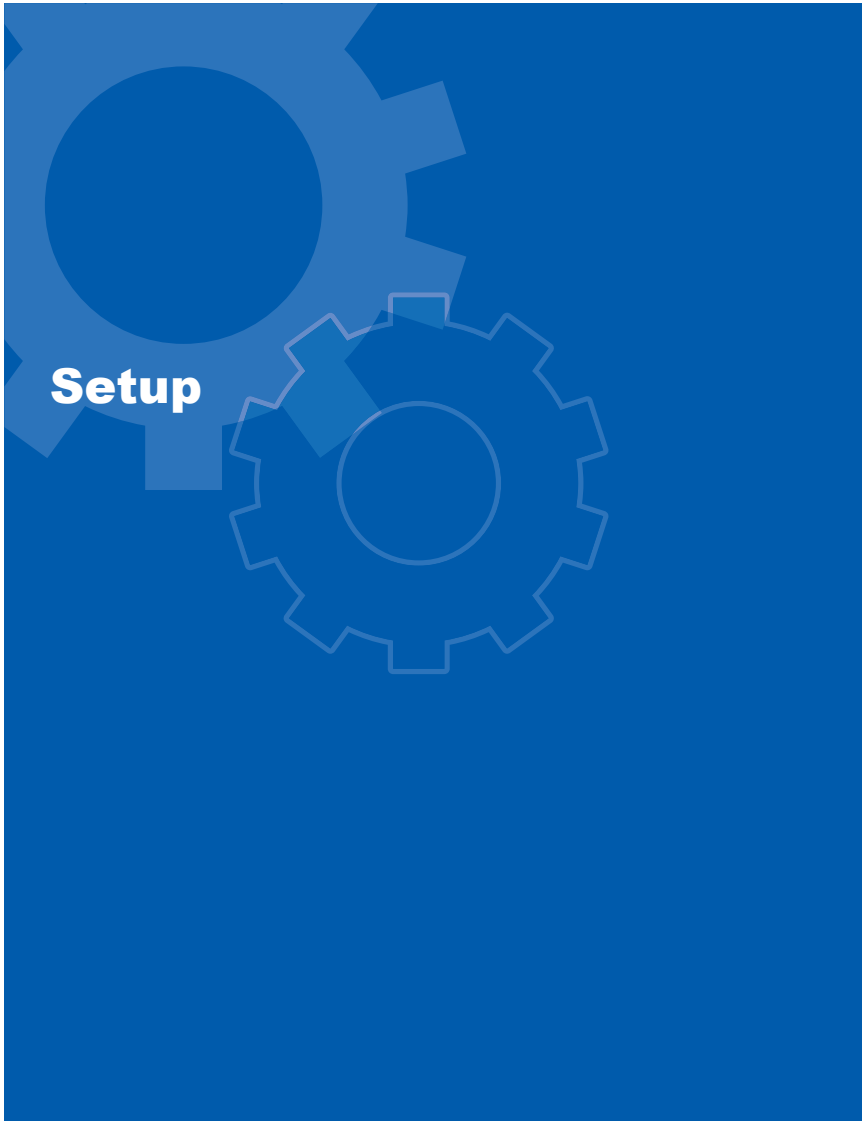



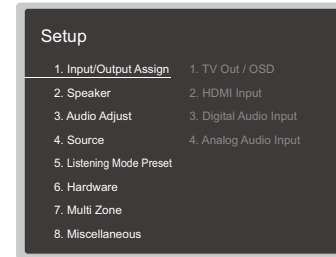



Use the on-screen displays (OSD) that appear on the TV to make the settings. Press  on the remote controller to display the Setup menu.



Select the item with the cursors  /  of the remote controller, and press the Enter button to confirm your selection.

Use the cursors  /  to change the default values.

- To return to the previous screen, press .
- To exit the settings, press the .



# Setup Menu

## Menu list

|                               |                                 |                                                                                                                       |                      |
|-------------------------------|---------------------------------|-----------------------------------------------------------------------------------------------------------------------|----------------------|
| <b>1. Input/Output Assign</b> | <b>1. TV Out / OSD</b>          | Make settings for TV output and On-Screen Displays (OSD) that appear on the TV.                                       | <a href="#">p100</a> |
|                               | <b>2. HDMI Input</b>            | You can change input assignment between the input selectors and HDMI IN jacks.                                        | <a href="#">p102</a> |
|                               | <b>3. Digital Audio Input</b>   | Change input assignment between the input selectors and DIGITAL IN COAXIAL/OPTICAL jacks.                             | <a href="#">p103</a> |
|                               | <b>4. Analog Audio Input</b>    | Change input assignment between the input selectors and AUDIO IN jacks.                                               | <a href="#">p103</a> |
| <b>2. Speaker</b>             | <b>1. Configuration</b>         | Change the settings of connection environment of the speakers.                                                        | <a href="#">p104</a> |
|                               | <b>2. Crossover</b>             | Change the settings of crossover frequencies.                                                                         | <a href="#">p105</a> |
|                               | <b>3. Distance</b>              | Set the distance from each speaker to the listening position.                                                         | <a href="#">p106</a> |
|                               | <b>4. Level Calibration</b>     | Adjust the volume level of each speaker.                                                                              | <a href="#">p106</a> |
|                               | <b>5. Dolby Enabled Speaker</b> | Change the settings of Dolby Enabled Speakers.                                                                        | <a href="#">p107</a> |
|                               | <b>6. Equalizer Settings</b>    | You can adjust the output volume of the range for each connected speaker.                                             | <a href="#">p107</a> |
|                               | <b>7. Speaker Virtualizer</b>   | The Speaker Virtualizer function can be switched between On and Off.                                                  | <a href="#">p108</a> |
| <b>3. Audio Adjust</b>        | <b>1. Multiplex/Mono</b>        | Change the settings of multiplex audio playback.                                                                      | <a href="#">p109</a> |
|                               | <b>2. Dolby</b>                 | Change the setting of when Dolby signals are input.                                                                   | <a href="#">p109</a> |
|                               | <b>3. DTS</b>                   | Change the setting of when DTS signals are input.                                                                     | <a href="#">p109</a> |
|                               | <b>4. LFE Level</b>             | Set the low-frequency effect (LFE) level for Dolby Digital series, DTS series, Multichannel PCM, and DSD signals.     | <a href="#">p110</a> |
|                               | <b>5. Volume</b>                | Change the Volume settings.                                                                                           | <a href="#">p110</a> |
| <b>4. Source</b>              | <b>1. My Input Volume</b>       | Set a volume value for each input selector.                                                                           | <a href="#">p111</a> |
|                               | <b>2. Name Edit</b>             | Set an easy name for each input.                                                                                      | <a href="#">p111</a> |
|                               | <b>Audio Select</b>             | Select the prioritized input terminal when multiple audio sources are connected to one input selector.                | <a href="#">p111</a> |
|                               | <b>Video Select</b>             | When "TUNER", "NET", or "BLUETOOTH" input is selected, you can set the input from which video is displayed on the TV. | <a href="#">p112</a> |



|                                 |                            |                                                                        |                      |
|---------------------------------|----------------------------|------------------------------------------------------------------------|----------------------|
| <b>5. Listening Mode Preset</b> | <b>1. BD/DVD</b>           | Preset the favorite listening mode when "BD/DVD" input is selected.    | <a href="#">p113</a> |
|                                 | <b>2. GAME</b>             | Preset the favorite listening mode when "GAME" input is selected.      | <a href="#">p113</a> |
|                                 | <b>3. CBL/SAT</b>          | Preset the favorite listening mode when "CBL/SAT" input is selected.   | <a href="#">p113</a> |
|                                 | <b>4. STRM BOX</b>         | Preset the favorite listening mode when "STRM BOX" input is selected.  | <a href="#">p113</a> |
|                                 | <b>5. PC</b>               | Preset the favorite listening mode when "PC" input is selected.        | <a href="#">p113</a> |
|                                 | <b>6. AUX</b>              | Preset the favorite listening mode when "AUX" input is selected.       | <a href="#">p113</a> |
|                                 | <b>7. CD</b>               | Preset the favorite listening mode when "CD" input is selected.        | <a href="#">p113</a> |
|                                 | <b>8. TV</b>               | Preset the favorite listening mode when "TV" input is selected.        | <a href="#">p113</a> |
|                                 | <b>9. PHONO</b>            | Preset the favorite listening mode when "PHONO" input is selected.     | <a href="#">p113</a> |
|                                 | <b>10. TUNER</b>           | Preset the favorite listening mode when "TUNER" input is selected.     | <a href="#">p113</a> |
|                                 | <b>11. NET</b>             | Preset the favorite listening mode when "NET" input is selected.       | <a href="#">p113</a> |
|                                 | <b>12. BLUETOOTH</b>       | Preset the favorite listening mode when "BLUETOOTH" input is selected. | <a href="#">p113</a> |
| <b>6. Hardware</b>              | <b>1. HDMI</b>             | Change the settings for the HDMI functions.                            | <a href="#">p114</a> |
|                                 | <b>2. Network</b>          | Change the settings for the Network functions.                         | <a href="#">p116</a> |
|                                 | <b>3. Bluetooth</b>        | Change the settings for the BLUETOOTH function.                        | <a href="#">p119</a> |
|                                 | <b>4. Power Management</b> | Change the settings for the power-save function.                       | <a href="#">p121</a> |
|                                 | <b>5. 12V Trigger A</b>    | Change the settings for 12V TRIGGER A OUT jack.                        | <a href="#">p122</a> |
|                                 | <b>6. 12V Trigger B</b>    | Change the settings for 12V TRIGGER B OUT jack.                        | <a href="#">p123</a> |
|                                 | <b>7. 12V Trigger C</b>    | Change the settings for 12V TRIGGER C OUT jack.                        | <a href="#">p123</a> |
|                                 | <b>8. Works with SONOS</b> | Change the settings to connect with the Sonos Connect.                 | <a href="#">p124</a> |
| <b>7. Multi Zone</b>            | <b>1. Zone 2</b>           | Change the settings for Zone 2.                                        | <a href="#">p125</a> |
|                                 | <b>2. Remote Play Zone</b> | Change the settings for remote play.                                   | <a href="#">p125</a> |
| <b>8. Miscellaneous</b>         | <b>1. Tuner</b>            | Change the settings for Tuner.                                         | <a href="#">p126</a> |
|                                 | <b>2. Remote ID</b>        | Change the remote controller ID.                                       | <a href="#">p126</a> |
|                                 | <b>3. Firmware Update</b>  | Change the settings for Firmware Update.                               | <a href="#">p126</a> |
|                                 | <b>4. Initial Setup</b>    | Make the initial setup from the setup menu.                            | <a href="#">p126</a> |
|                                 | <b>5. Lock</b>             | Lock the Setup menu so that the settings cannot be changed.            | <a href="#">p127</a> |
|                                 | <b>6. Factory Reset</b>    | All the settings are restored to factory defaults.                     | <a href="#">p127</a> |



# 1. Input/Output Assign

## 1. TV Out / OSD

Make settings for TV output and On-Screen Displays (OSD) that appear on the TV.

### □ HDMI Out (Default Value: MAIN)

Select the HDMI jack to be connected with the TV.

- If devices with different resolutions are connected to HDMI OUT MAIN jack and SUB jack, images are output with the lower resolution.

|          |                                                  |
|----------|--------------------------------------------------|
| MAIN     | When connecting the TV to the HDMI OUT MAIN jack |
| SUB      | When connecting the TV to the HDMI OUT SUB jack  |
| MAIN+SUB | When connecting to both the MAIN and SUB jacks   |

### □ Dolby Vision (Default Value: MAIN)

To output Dolby Vision video from the player to a TV that supports Dolby Vision, select either the HDMI OUT MAIN jack or HDMI OUT SUB jack to which the Dolby Vision-supported TV is connected. This setting is only necessary if you have set "HDMI Out" to "MAIN+SUB" and you have connected a TV to both the MAIN and SUB jacks.

|      |                                                                                                 |
|------|-------------------------------------------------------------------------------------------------|
| MAIN | To output Dolby Vision video to a Dolby Vision-supported TV connected to the HDMI OUT MAIN jack |
| SUB  | To output Dolby Vision video to a Dolby Vision-supported TV connected to the HDMI OUT SUB jack  |
| Off  | After selecting "MAIN" or "SUB", if the video on the TV does not appear correctly               |

### □ 1080p -> 4K Upscaling (Default Value: Off)

When a TV supporting 4K is used, video signals input with 1080p can be automatically output with 4K.

- If the TV does not support the 4K resolution with the same frequency as the frequency of HDMI input video signals, upscaling to 4K is not correctly performed. Check the frequency of 4K resolution supported by the TV, and change the resolution of the video signals input from the AV component.

|      |                                                                                      |
|------|--------------------------------------------------------------------------------------|
| Off  | When this function is not used<br>• If your TV does not support 4K, set it to "Off". |
| Auto | When this function is used                                                           |

### □ Super Resolution (Default Value: 2)

When "1080p -> 4K Upscaling" is set to "Auto", select the correction level of the input video signals from "Off" and "1" (weak) to "3" (strong).



# 1. Input/Output Assign

## ❑ HDMI 4K/8K Signal Format (Default Value: 4K Standard)

Set the 4K/8K signal format input and output by this unit. Set to suit the TV or player connected.

- The corresponding resolution is different depending on the HDMI jack connected. See "Corresponding input resolutions" ( →p162) for details.

|             |                                                                                                                                                                                                                                                                                                                                                               |
|-------------|---------------------------------------------------------------------------------------------------------------------------------------------------------------------------------------------------------------------------------------------------------------------------------------------------------------------------------------------------------------|
| 4K Standard | When using a High Speed HDMI Cable that supports 10.2 Gbps to connect a TV or player compatible with standard 4K signal formats (4K 30Hz, etc.)                                                                                                                                                                                                               |
| 4K Enhanced | When using a Premium High Speed HDMI Cable that supports 18 Gbps to connect a TV or player compatible with high-definition 4K signal formats (4K 60Hz, 4K HDR, etc.) <ul style="list-style-type: none"> <li>• There may be some image disruption depending on the connected component and the HDMI cable. If this occurs, switch to "4K Standard".</li> </ul> |
| 8K Standard | When using a Premium High Speed HDMI Cable that supports 18 Gbps or an Ultra High Speed HDMI Cable that supports 48 Gbps to connect a TV or player compatible with 4K/120p or 5K/8K signal formats                                                                                                                                                            |

## ❑ Zone 2 HDMI (Default Value: Not Use)

Make the setting when you output to the Zone 2 TV connected to the HDMI OUT SUB/ZONE 2 jack.

|         |                                                                                                                                                      |
|---------|------------------------------------------------------------------------------------------------------------------------------------------------------|
| Use     | Enable this function                                                                                                                                 |
| Not Use | Disable this function <ul style="list-style-type: none"> <li>• When video and audio via HDMI input are output to ZONE 2, set it to "Use".</li> </ul> |

## ❑ OSD Language (Default Value: English)

Select the on-screen display language from the following.  
English, German, French, Spanish, Italian, Dutch, Swedish, Russian, Chinese

## ❑ Impose OSD (Default Value: On)

Set whether or not to display information such as volume adjustment or switching of input on the TV screen.

|     |                                                                                                                                                                                                                              |
|-----|------------------------------------------------------------------------------------------------------------------------------------------------------------------------------------------------------------------------------|
| On  | OSD is displayed on the TV <ul style="list-style-type: none"> <li>• OSD may not be displayed depending on the input signal even if "On" is selected. In this case, change the resolution of the connected device.</li> </ul> |
| Off | OSD is not displayed on the TV                                                                                                                                                                                               |



# 1. Input/Output Assign

## □ Mini Player OSD (Default Value: Always On)

You can display on the TV the images from another input selected last while playing the audio from NET or BLUETOOTH input. After switching the input to NET or BLUETOOTH, play the images and audio. And then when you press Mode on the remote controller, the image is displayed in full-screen mode, and the audio information (Mini Player) for NET or BLUETOOTH is displayed in the corner of the screen. You can set whether to always display this Mini Player on the screen.

- Each time the Mode button is pressed, the image display/non-display can be switched.
- This setting cannot be selected if "Impose OSD" is set to "Off".
- This function cannot be used when "OSD Language" is set to Chinese.

|           |                                                                                                                                                                     |
|-----------|---------------------------------------------------------------------------------------------------------------------------------------------------------------------|
| Always On | The Mini Player is always displayed.                                                                                                                                |
| Auto Off  | The Mini Player turns off automatically in 30 seconds after displayed. If operation such as changing the volume is performed, it is displayed again for 30 seconds. |

## □ Screen Saver (Default Value: 3 minutes)

Set the time to start the screen saver.

Select a value from "3 minutes", "5 minutes", "10 minutes" and "Off".

## ■ 2. HDMI Input

You can change input assignment between the input selectors and HDMI IN jacks.

- **BD/DVD** (Default Value: HDMI 1 (HDCP 2.3))
- GAME** (Default Value: HDMI 2 (HDCP 2.3))
- CBL/SAT** (Default Value: HDMI 3 (HDCP 2.3))
- STRM BOX** (Default Value: HDMI 4 (HDCP 2.3))
- PC** (Default Value: HDMI 5 (HDCP 2.3))
- AUX** (Default Value: HDMI 6 (HDCP 2.3))
- CD** (Default Value: ---)
- TV** (Default Value: ---)
- PHONO** (Default Value: ---)

"HDMI 1 (HDCP 2.3)" to "HDMI 6 (HDCP 2.3)":

Assign any HDMI IN jack to each of the input selectors. If you do not assign a jack, select "---". To select an HDMI IN jack already assigned to another input selector, change its setting to "---" first.



# 1. Input/Output Assign

## 3. Digital Audio Input

Change input assignment between the input selectors and DIGITAL IN COAXIAL/OPTICAL jacks. If you do not assign a jack, select "---".

- BD/DVD** (Default Value: **COAXIAL**)
- GAME** (Default Value: ---)
- CBL/SAT** (Default Value: ---)
- STRM BOX** (Default Value: ---)
- PC** (Default Value: ---)
- CD** (Default Value: ---)
- TV** (Default Value: **OPTICAL**)
- PHONO** (Default Value: ---)

|                     |                                                                        |
|---------------------|------------------------------------------------------------------------|
| COAXIAL,<br>OPTICAL | Assign the COAXIAL terminal or OPTICAL terminal to any input selector. |
|---------------------|------------------------------------------------------------------------|

- Supported sampling rates for PCM signals (stereo, mono) from a digital input are 32 kHz, 44.1 kHz, 48 kHz, 88.2 kHz, 96 kHz/16 bit, 20 bit, and 24 bit.

## 4. Analog Audio Input

Change input assignment between the input selectors and AUDIO IN jacks. If you do not assign a jack, select "---".

- BD/DVD** (Default Value: **AUDIO 1**)
- GAME** (Default Value: ---)
- CBL/SAT** (Default Value: **AUDIO 2**)
- STRM BOX** (Default Value: **AUDIO 3**)
- PC** (Default Value: ---)
- CD** (Default Value: **AUDIO 4**)
- TV** (Default Value: ---)
- PHONO** (Default Value: **PHONO**)

- The setting cannot be changed.

|                                             |                                                     |
|---------------------------------------------|-----------------------------------------------------|
| AUDIO 1,<br>AUDIO 2,<br>AUDIO 3,<br>AUDIO 4 | Assign the AUDIO IN terminal to any input selector. |
|---------------------------------------------|-----------------------------------------------------|



## 2. Speaker

### 1. Configuration

Change the settings of connection environment of the speakers.

#### Speaker Channels (Default Value: 7.1 ch)

Select "2.1 ch", "3.1 ch", "4.1 ch", "5.1 ch", "6.1 ch", "7.1 ch", "2.1.2 ch", "3.1.2 ch", "4.1.2 ch", or "5.1.2 ch" to suit the number of speaker channels connected.

#### Subwoofer (Default Value: Yes)

Set whether a subwoofer is connected or not.

|     |                                   |
|-----|-----------------------------------|
| Yes | When a subwoofer is connected     |
| No  | When a subwoofer is not connected |

#### Height Speaker (Default Value: Top Middle)

Set the speaker type if height speakers are connected. Select "Top Middle", "Top Rear", "Rear High", "Dolby Speaker (Front)", "Dolby Speaker (Surr)", "Front High" or "Top Front" according to the type and layout of the connected speakers.

- If an item cannot be selected even though connection is correct, check that the settings in "Speaker Channels" matches the number of connected channels.

#### Zone Speaker (Default Value: No)

Set the connection of speakers to Zone 2 speaker terminals.

- This setting cannot be selected when "Zone 2 Preout" is set to an item other than "Zone 2".

|        |                                                             |
|--------|-------------------------------------------------------------|
| Zone 2 | When speakers are connected to Zone 2 speaker terminals     |
| No     | When speakers are not connected to Zone 2 speaker terminals |

#### Zone 2 Preout (Default Value: Zone 2)

Set an output destination of the audio output from ZONE 2 PRE/LINE OUT/ZONE B LINE OUT jack.

- This setting is fixed to "Zone 2" when "Zone Speaker" is set to "Zone 2".

|        |                                                                                             |
|--------|---------------------------------------------------------------------------------------------|
| Zone 2 | When connecting an integrated amplifier in a separate room (ZONE 2)                         |
| Zone B | When connecting an integrated amplifier, transmitter of wireless headphones, etc. to ZONE B |
| Front  | When connecting a power amplifier                                                           |

#### Bi-Amp (Default Value: No)

Set whether the front speakers are bi-amp connected.

- This setting cannot be selected when surround back speakers or height speakers (4.1.2 ch, 5.1.2 ch) are installed.

|     |                                                                                                                       |
|-----|-----------------------------------------------------------------------------------------------------------------------|
| No  | When front speakers are not bi-amp connected<br>• This setting is fixed to "No" if "Zone Speaker" is set to "Zone 2". |
| Yes | When front speakers are bi-amp connected                                                                              |

#### Speaker Impedance (Default Value: 6 ohms or above)

Set the impedance ( $\Omega$ ) of the connected speakers.

- For impedance, check the indications on the back of the speakers or their instruction manual.

|                 |                                                                                              |
|-----------------|----------------------------------------------------------------------------------------------|
| 4ohms           | When any of the connected speakers have 4 $\Omega$ or more to less than 6 $\Omega$ impedance |
| 6 ohms or above | When all the connected speakers have an impedance of 6 $\Omega$ or more                      |





## 2. Speaker

### ■ 2. Crossover

Change the settings of crossover frequencies.

- Front** (Default Value: 100 Hz)
- Center** (Default Value: 100 Hz)
- Height** (Default Value: 100 Hz)
- Surround** (Default Value: 100 Hz)
- Surround Back** (Default Value: 100 Hz)
- LPF of LFE** (Default Value: 120 Hz)
- Double Bass** (Default Value: On)

#### Front:

Select the crossover frequency from "40 Hz" to "200 Hz" to start outputting frequencies for each channel.

"Full Band": Full band will be output.

- If "Configuration" - "Subwoofer" is set to "No", "Front" is fixed to "Full Band", and the low pitched range of the other channels is output from the front speakers. Refer to the instruction manual of your speakers to make the setting.

#### Center, Height, Surround:

Select the crossover frequency from "40 Hz" to "200 Hz" to start outputting frequencies for each channel.

"Full Band": Full band will be output.

- "Full Band" can be selected only when "Front" is set to "Full Band".
- If the item cannot be selected even though connection is correct, check if the setting in "Configuration" - "Speaker Channels" matches the number of connected channels.

#### Surround Back:

Select the crossover frequency from "40 Hz" to "200 Hz" to start outputting frequencies for each channel.

"Full Band": Full band will be output.

- "Full Band" can be selected only when "Surround" is set to "Full Band".
- If the item cannot be selected even though connection is correct, check if the setting in "Configuration" - "Speaker Channels" matches the number of connected channels.

#### LPF of LFE:

Set the low-pass filter for LFE (low-frequency effect) signals in order to pass only the lower frequency signals than the set value, and thus cancel unwanted noises. The low-pass filter is effective only on sources with LFE channel.

The value from "80 Hz" to "120 Hz" can be set.

"Off": When this function is not used

#### Double Bass:

This can be selected only when "Configuration" - "Subwoofer" is set to "Yes" and "Front" is set to "Full Band".

Boost bass output by feeding bass sounds from the front left and right speakers and the center speaker to the subwoofer.

"On": Bass output is boosted.

"Off": Bass output is not boosted.

- This function is not automatically set even if AccuEQ Room Calibration is performed.



## 2. Speaker

### ■ 3. Distance

Set the distance from each speaker to the listening position.

- Front Left** (Default Value: 12.0 ft/3.60 m)
- Center** (Default Value: 12.0 ft/3.60 m)
- Front Right** (Default Value: 12.0 ft/3.60 m)
- Height Left** (Default Value: 9.0 ft/2.70 m)
- Height Right** (Default Value: 9.0 ft/2.70 m)
- Surround Right** (Default Value: 7.0 ft/2.10 m)
- Surr Back Right** (Default Value: 7.0 ft/2.10 m)
- Surr Back Left** (Default Value: 7.0 ft/2.10 m)
- Surround Left** (Default Value: 7.0 ft/2.10 m)
- Subwoofer** (Default Value: 12.0 ft/3.60 m)

- Default values vary depending on the regions.
- The unit of distance can be changed by pressing the Mode button on the remote controller. When using the unit "feet", the setting is available in increments of 0.1 ft from 0.1 ft to 30.0 ft. When using the unit "meter", the setting is available in increments of 0.03 m from 0.03 m to 9.00 m.

(Height Left, Height Right, Surr Back Right, Surr Back Left):

- The setting cannot be changed if "Configuration" - "Zone Speaker" is set to "Zone 2" and Zone 2 is on.

### ■ 4. Level Calibration

Adjust the volume level of each speaker.

- Front Left** (Default Value: 0.0 dB)
- Center** (Default Value: 0.0 dB)
- Front Right** (Default Value: 0.0 dB)
- Height Left** (Default Value: 0.0 dB)
- Height Right** (Default Value: 0.0 dB)
- Surround Right** (Default Value: 0.0 dB)
- Surr Back Right** (Default Value: 0.0 dB)
- Surr Back Left** (Default Value: 0.0 dB)
- Surround Left** (Default Value: 0.0 dB)
- Subwoofer** (Default Value: 0.0 dB)

---

Select a value between "-12.0 dB" and "+12.0 dB" ("-15.0 dB" and "+12.0 dB" for Subwoofer) (in 0.5 dB increments). A test tone will be output each time you change the value. Select the desired level.

---

(Height Left, Height Right, Surr Back Right, Surr Back Left):

- The setting cannot be changed if "Configuration" - "Zone Speaker" is set to "Zone 2" and Zone 2 is on.



## 2. Speaker

### ■ 5. Dolby Enabled Speaker

Change the settings of Dolby Enabled Speakers.

- This setting can be selected when "Configuration" - "Height Speaker" is set to "Dolby Speaker".

#### □ Distance from the ceiling (Default Value: 6.0 ft/1.80 m)

Set the distance between the Dolby Enabled Speaker and the ceiling. Select between "0.1 ft"/"0.03 m" and "15.0 ft"/"4.50 m" ("0.1 ft"/"0.03 m" units).

- The unit of distance (ft/m) is displayed using the unit selected for the "Distance" setting.

#### □ AccuReflex (Default Value: Off)

You can enhance the reflection effect of Dolby Enabled Speakers from the ceiling.

|     |                                |
|-----|--------------------------------|
| Off | When this function is not used |
| On  | When this function is used     |

### ■ 6. Equalizer Settings

You can adjust the output volume of the range for each connected speaker. Adjust the volume of different sound ranges for each speaker. You can set three different equalizers in Preset 1 to 3. The number of frequencies that can be selected for each speaker is up to five bands for the Subwoofer and nine bands for the other speakers.

|               |                         |
|---------------|-------------------------|
| □ Front       | (Default Value: 0.0 dB) |
| Center        | (Default Value: 0.0 dB) |
| Height        | (Default Value: 0.0 dB) |
| Surround      | (Default Value: 0.0 dB) |
| Surround Back | (Default Value: 0.0 dB) |
| Subwoofer     | (Default Value: 0.0 dB) |

After selecting the speaker frequency from between "25 Hz" and "16 kHz" ("25 Hz" and "160 Hz" for Subwoofer) with the cursors ◀ / ▶, adjust the volume of that frequency between "-6.0 dB" and "+6.0 dB" with ▲ / ▼.

- Depending on the input source or listening mode setting, the desired effect may not be achieved.

(Height, Surround Back):

- The setting cannot be changed if "Configuration" - "Zone Speaker" is set to "Zone 2" and Zone 2 is on.

(Subwoofer):

- This cannot be selected if "Configuration" - "Subwoofer" is set to "No".



## 2. Speaker

### ■ 7. Speaker Virtualizer

The Speaker Virtualizer function can be switched between On and Off.

#### □ Speaker Virtualizer (Default Value: On)

|     |                                                                                   |
|-----|-----------------------------------------------------------------------------------|
| On  | Listening modes such as T-D that have virtual speaker effects can be selected.    |
| Off | Listening modes such as T-D that have virtual speaker effects cannot be selected. |



## 3. Audio Adjust

### ■ 1. Multiplex/Mono

Change the settings of multiplex audio playback.

#### □ Multiplex Input Channel (Default Value: Main)

Set the audio channel or language to be output when playing multiplex audio or multilingual broadcasts, etc.

- For multiplex audio broadcasts, pressing the **i** button on the remote controller will display "1+1" on the main unit's display.

|            |                                                        |
|------------|--------------------------------------------------------|
| Main       | Main channel only                                      |
| Sub        | Sub channel only                                       |
| Main / Sub | Main and sub channels will be output at the same time. |

#### □ Mono Input Channel (Default Value: Left + Right)

Set the input channel when playing in Mono listening mode digital signals such as Dolby Digital or analog/PCM signals recorded in 2 channels.

|              |                         |
|--------------|-------------------------|
| Left         | Left channel only       |
| Right        | Right channel only      |
| Left + Right | Left and right channels |

### ■ 2. Dolby

Change the setting of when Dolby signals are input.

#### □ Loudness Management (Default Value: On)

When playing Dolby TrueHD, enable the dialog normalization function which keeps the volume of dialog at a certain level. Note that when this setting is Off, the Late Night function that allows you to enjoy surround at low volumes is fixed to off when playing Dolby Digital Plus/Dolby TrueHD.

|     |                                |
|-----|--------------------------------|
| On  | When this function is used     |
| Off | When this function is not used |

### ■ 3. DTS

Change the setting of when DTS signals are input.

#### □ DTS Auto Surround (Default Value: On)

When inputting DTS signals that include extended channel information, the optimum listening mode is automatically selected according to the extended information contained in the input signal and the speaker configuration of this unit when playing in the straight decoding listening mode.

|     |                                                                                                                                                                                                                                                                                    |
|-----|------------------------------------------------------------------------------------------------------------------------------------------------------------------------------------------------------------------------------------------------------------------------------------|
| On  | When this function is used                                                                                                                                                                                                                                                         |
| Off | Audio is played using the same amount of channels in the input signal according to the speaker configuration of this unit. <ul style="list-style-type: none"> <li>• If this function is set to "Off", the ES Matrix and ES Discrete listening modes cannot be selected.</li> </ul> |

#### □ Dialog Control (Default Value: 0 dB)

You can increase the volume of dialog portion of the audio up to 6 dB by 1 dB step so that you can hear the dialog easily in noisy atmosphere.

- This cannot be set for content other than DTS:X.
- Depending on the content, this function may not be selected.



### 3. Audio Adjust

#### ■ 4. LFE Level

Set the low-frequency effect (LFE) level for Dolby Digital series, DTS series, Multichannel PCM, and DSD signals.

##### □ LFE Level (Default Value: 0 dB)

Select the low-frequency effect (LFE) level of each signal from "0 dB" to "-∞ dB". If the low-frequency effect sound is too strong, select "-20 dB" or "-∞ dB".

#### ■ 5. Volume

Change the Volume settings.

##### □ Mute Level (Default Value: -∞ dB)

Set the volume lowered from the listening volume when muting is on. Select a value from "-∞ dB", "-40 dB", and "-20 dB".

##### □ Maximum Volume (Default Value: Off)

Set the maximum value to prevent the volume from becoming too loud. Select a value from "Off", and "50" to "99".

##### □ Power On Volume (Default Value: Last)

Set the volume level of when the power is turned on. Select a value from "Last" (Volume level before entering standby mode), "Min", "0.5" to "99.5" and "Max".

- You cannot set a higher value than that of "Maximum Volume".

##### □ Headphone Level (Default Value: 0.0 dB)

Adjust the output level of headphones. Select a value between "-12.0 dB" and "+12.0 dB".



## 4. Source

### ■ 1. My Input Volume

Set a volume value for each input selector.

#### □ My Input Volume (Default Value: Last)

Select a value from "Last", "Min", "0.5" to "81.5" and "Max".

- The volume level when the power is turned on is the value set for "Power On Volume".
- To set the volume to the current volume, press the button of the input selector you wish to set for approx. 3 seconds.

### ■ 2. Name Edit

Set an easy name for each input. The set name appears on the main unit's display. Select the input selector to make the setting.

#### □ Name Edit (Default Value: Input name)

- Select a character or symbol with the cursors, and press Enter.  
Repeat this operation to input up to 10 characters.  
"A/a": Switches between upper and lower cases. (Pressing Mode on the remote controller also toggles between upper and lower cases)  
"←" "→": Moves the cursor in the arrow direction.  
"⊗": Removes a character on the left of the cursor.  
"␣": Enters a space.
  - Pressing Clear on the remote controller will remove all the input characters.
- After inputting, select "OK" with the cursors, and press Enter.  
The input name will be saved.  
To restore the name to the default value, press Clear on the remote controller on the input screen. Then while nothing is entered, select "OK", and press Enter.
  - To name a preset radio station, press Tuner on the remote controller, select AM/FM and select the preset number.
  - This cannot be set if the "NET" or "BLUETOOTH" input is selected.

### ■ Audio Select

Select the priority for input selection when multiple audio sources are connected to one input selector, such as connections to both the "BD/DVD" HDMI IN jack and the "BD/DVD" AUDIO IN jack. The setting can be separately set to each input selector button. Select the input selector to configure. Note that there are some default values you cannot change.

- BD/DVD (Default Value: HDMI)
- GAME (Default Value: HDMI)
- CBL/SAT (Default Value: HDMI)
- STRM BOX (Default Value: HDMI)
- PC (Default Value: HDMI)
- AUX (Default Value: HDMI)
- CD (Default Value: Analog)
- PHONO (Default Value: Analog)
- TV (Default Value: OPTICAL)

|         |                                                                                                                                                                                                                                  |
|---------|----------------------------------------------------------------------------------------------------------------------------------------------------------------------------------------------------------------------------------|
| ARC     | When giving priority to input signal from ARC compatible TV.<br>• The setting can be selected only when "6. Hardware" - "HDMI" - "Audio Return Channel (eARC supported)" is set to "On" and also the "TV" input is selected.     |
| HDMI    | When giving priority to input signal from HDMI IN jacks<br>• This item can be selected only when the input to be set is assigned to the HDMI jack in the "1. Input/Output Assign" - "HDMI Input" setting.                        |
| COAXIAL | When giving priority to input signal from DIGITAL IN COAXIAL jacks<br>• This item can be selected only when the input to be set is assigned to the COAXIAL jack in the "1. Input/Output Assign" - "Digital Audio Input" setting. |
| OPTICAL | When giving priority to input signal from DIGITAL IN OPTICAL jacks<br>• This item can be selected only when the input to be set is assigned to the OPTICAL jack in the "1. Input/Output Assign" - "Digital Audio Input" setting. |



## 4. Source

|        |                                                                                                                                                                                                                                                                                |
|--------|--------------------------------------------------------------------------------------------------------------------------------------------------------------------------------------------------------------------------------------------------------------------------------|
| Analog | <p>When giving priority to the input signal from AUDIO IN jacks</p> <ul style="list-style-type: none"> <li>This item can be selected only when the input to be set is assigned to the AUDIO IN jack in the "1. Input/Output Assign" - "Analog Audio Input" setting.</li> </ul> |
|--------|--------------------------------------------------------------------------------------------------------------------------------------------------------------------------------------------------------------------------------------------------------------------------------|

### PCM Fixed Mode (Default Value: Off)

Select whether to fix input signals to PCM (except multi-channel PCM) when you select "HDMI", "COAXIAL", or "OPTICAL" in the "Audio Select" setting. Set this item to "On" if noise is produced or truncation occurs at the beginning of a track when playing PCM sources. Select "Off" normally.

- Each time the "Audio Select" setting is changed, the setting is restored to "Off".
- The setting cannot be changed when "TUNER", "NET", or "BLUETOOTH" input is selected.

## ■ Video Select

When "TUNER", "NET", or "BLUETOOTH" input is selected, you can set the input from which video is displayed on the TV.

### Video Select (Default Value: Last)

|                                                    |                                                                                                                                                                                                      |
|----------------------------------------------------|------------------------------------------------------------------------------------------------------------------------------------------------------------------------------------------------------|
| Last                                               | Select the video input played immediately prior.                                                                                                                                                     |
| BD/DVD, GAME, CBL/SAT, STRM BOX, PC, CD, TV, PHONO | <p>Play the video of each input.</p> <ul style="list-style-type: none"> <li>This setting is effective for an input selector which is assigned in "1. Input/Output Assign" - "HDMI Input".</li> </ul> |

- If the OSD language is set to Chinese, you can only select this setting when "TUNER" is selected as input.





## 5. Listening Mode Preset

You can preset your favorite listening mode to each input. (For example, you can always apply straight decode to the Dolby TrueHD source of Blu-ray Disc to play it in unchanged sound field.)

When the list of input sources is displayed, set the signal type and listening mode.

Although it is possible to select the listening mode during playback, the selected mode will be reset when the unit enters standby mode.

### ❑ Analog/PCM (Default Value: All Ch Stereo)

Set the listening mode for playing PCM signals of CD and analog signals of record and cassette tape.

### ❑ Dolby (Default Value: Dolby Audio - Surr)

Set the listening mode for playing Dolby Digital, Dolby Digital Plus and Dolby TrueHD signals.

- Input signals are played as they are input if you select "Straight Decode".

### ❑ DTS (Default Value: DTS Neural:X)

Set the listening mode for playing digital audio signals in DTS and DTS-HD High Resolution formats. Select the listening mode specified for Blu-ray or such other DTS-HD Master Audio source.

- Input signals are played as they are input if you select "Straight Decode".

### ❑ Other (Default Value: Dolby Audio - Surr)

Set the listening mode for playing audio such as DVD-audio and DSD signals.

- Input signals are played as they are input if you select "Straight Decode".

- Available listening modes vary depending on speaker configuration and the input signal.
- Setting "Last Valid" will always select the last selected mode.
- Only "Analog" can be set to the "TUNER" or "AUX" input.
- "Digital" and "DSD" can be set to the "NET" input.
- Only "Digital" can be set to the "BLUETOOTH" input.



## 6. Hardware

### ■ 1. HDMI

Change the settings of the HDMI function.

#### □ HDMI CEC (Default Value: On)

Setting this to "On" enables the input selection link and other link functions with HDMI-connected CEC-compatible device.

When this setting is changed, turn off and then on again the power of all connected devices.

- Depending on the TV to use, a link setting may be required on the TV.
- This function is effective only when the device is connected to the HDMI OUT MAIN terminal.
- Setting this to "On" and closing the operation screen will display the name of the connected CEC-compatible device and "CEC On" on the main unit's display.
- When this function is set to "On", the power consumption in standby state increases, however, the increase in power consumption is minimized by automatically entering the Hybrid Standby mode where only the essential circuits operate.
- If you operate the Master Volume dial on the main unit when this setting is "On" and audio is output from the TV speakers, audio will be output also from the speakers connected to this unit. To output audio from only either of them, change the setting of this unit or TV, or reduce the volume of this unit.
- If abnormal behavior is observed when this is set to "On", set it to "Off".
- If a connected device is not CEC-compatible, or if you are not sure whether it is compatible, set it to "Off".

|     |                                |
|-----|--------------------------------|
| On  | When this function is used     |
| Off | When this function is not used |

#### □ HDMI Standby Through (Default Value: Auto (Eco))

When this is set to anything other than "Off", you can play the video and audio of an HDMI-connected player on the TV even if the unit is in standby mode. Also, only "Auto" and "Auto (Eco)" can be selected if "HDMI CEC" is set to "On". If you select anything else, set "HDMI CEC" to "Off".

- When this function is set to a value other than "Off", the power consumption in standby state increases, however, the increase in power consumption is minimized by automatically entering the Hybrid Standby mode where only the essential circuits operate.
- To play a non-CEC compliant player on the TV, turn the unit on and switch the input.
- When using a CEC-compliant TV, you can reduce the power consumption in standby mode by selecting "Auto (Eco)".

|                                                                                 |                                                                                                                                                                                                                                                                                                   |
|---------------------------------------------------------------------------------|---------------------------------------------------------------------------------------------------------------------------------------------------------------------------------------------------------------------------------------------------------------------------------------------------|
| Off                                                                             | When this function is not used                                                                                                                                                                                                                                                                    |
| BD/DVD,<br>GAME,<br>CBL/SAT,<br>STRM BOX,<br>PC,<br>AUX,<br>CD,<br>TV,<br>PHONO | For example, if you select "BD/DVD", you can play the equipment connected to the "BD/DVD" jack on the TV even if the unit is in standby mode. Select this setting if you have decided which player to use with this function.                                                                     |
| Last                                                                            | You can play on the TV the video and audio of the input selected immediately before the unit is switched to standby. When "Last" is selected, you can switch the input of the unit using the remote controller or the Integra Control Pro even in the standby mode.                               |
| Auto,<br>Auto (Eco)                                                             | Select one of these settings when you have connected equipment that conforms to the CEC standard. You can play the video and audio of the input selected on the TV, irrespective of what input was selected immediately prior to the unit being switched to standby, using the CEC link function. |



## 6. Hardware

### □ Audio TV Out (Default Value: Auto)

You can enjoy audio through the speakers of the TV while this unit is on.

- This setting is fixed to "Auto" if you set "1. Input/Output Assign" - "TV Out/ OSD" - "HDMI Out" or "HDMI" - "HDMI Out" in the "Quick Menu" to "MAIN" or "MAIN+SUB" and set "HDMI CEC" to "On". If you change this setting, set "HDMI CEC" to "Off".
- Listening mode cannot be changed while "Audio TV Out" is set to "On" and audio is being output from the TV.
- Depending on your TV or input signal of the connected device, audio may not be output from the TV even if this is set to "On". In such a case, audio is output from the speakers of the unit.
- Audio is output from this unit if you operate the Master Volume dial on this unit when audio that is input to this unit is output from your TV speakers. If you do not want to output audio, change the setting of this unit or TV, or reduce the volume of this unit.

|      |                                                                                                                                                                                                       |
|------|-------------------------------------------------------------------------------------------------------------------------------------------------------------------------------------------------------|
| On   | When this function is used                                                                                                                                                                            |
| Off  | When this function is not used                                                                                                                                                                        |
| Auto | When the "HDMI Out" setting is "MAIN" or "MAIN+SUB" and the "HDMI CEC" setting is "On" <ul style="list-style-type: none"> <li>• In this case, it is fixed at "Auto" and cannot be changed.</li> </ul> |

### □ Audio Return Channel (eARC supported) (Default Value: On)

You can enjoy the sound of an HDMI-connected ARC-compatible TV or eARC-compatible TV through the speakers connected to the unit.

|     |                                                                       |
|-----|-----------------------------------------------------------------------|
| On  | When enjoying the TV sound through the speakers connected to the unit |
| Off | When the ARC function or eARC function is not used                    |

### □ Auto Lip Sync (Default Value: On)

Automatically corrects desynchronization between the video and audio signals based on the information from the HDMI Lip-Sync-compatible TV.

|     |                                                  |
|-----|--------------------------------------------------|
| On  | When enabling the automatic correction function  |
| Off | When not using the automatic correction function |



## 6. Hardware

### ■ 2. Network

Change the settings of the Network function.

- When LAN is configured with a DHCP, set "DHCP" to "Enable" to configure the setting automatically. ("Enable" is set by default) To assign fixed IP addresses to each components, you must set "DHCP" to "Disable", assign an address to this unit in the "IP Address" setting, and set information related to your LAN, such as Subnet Mask and Gateway.

#### □ Wi-Fi (Default Value: Off(Wired))

Connect the unit to the network via a wireless LAN router.

- When switching between "On" and "Off(Wired)", stop the Network service. Also, when group playback is in process, cancel the group playback once, and then switch the setting.

|            |                         |
|------------|-------------------------|
| On         | Wireless LAN connection |
| Off(Wired) | Wired LAN connection    |

#### □ Wi-Fi Setup (Default Value: -)

Configure wireless LAN settings by pressing Enter with "Start" displayed.

#### □ Wi-Fi Status (Default Value: -)

The information of the connected access point is displayed.

|        |                                                |
|--------|------------------------------------------------|
| SSID   | SSID of the connected access point.            |
| Signal | Signal strength of the connected access point. |
| Status | Status of the connected access point.          |

#### □ MAC Address (Default Value: -)

Check the MAC address of this unit.

This value is specific to the component and cannot be changed.

#### □ DHCP (Default Value: Enable)

|         |                                                                                                                                                                                       |
|---------|---------------------------------------------------------------------------------------------------------------------------------------------------------------------------------------|
| Enable  | Auto configuration by DHCP                                                                                                                                                            |
| Disable | Manual configuration without DHCP <ul style="list-style-type: none"> <li>• If you select "Disable", set "IP Address", "Subnet Mask", "Gateway", and "DNS Server" manually.</li> </ul> |

#### □ IP Address (Default Value: 0.0.0.0)

Displays/Sets the IP address.

#### □ Subnet Mask (Default Value: 0.0.0.0)

Displays/Sets the subnet mask.

#### □ Gateway (Default Value: 0.0.0.0)

Displays/Sets the gateway.

#### □ DNS Server (Default Value: 0.0.0.0)

Displays/Sets the primary DNS server.

#### □ Proxy URL (Default Value: -)

Displays/Sets the proxy server URL.

#### □ Proxy Port (Default Value: 8080)

Displays/Sets the proxy server port number when you input "Proxy URL".



## 6. Hardware

### □ Friendly Name (Default Value: Integra DRX-2.4 XXXXXX)

Change the model name of this unit which is displayed on the device connected to the network to an easily recognized name.

1. Press Enter to display the Edit screen.
2. Select a character or symbol with the cursors, and press Enter. Repeat this operation to input up to 31 characters.
  - "A/a": Switches between upper and lower cases. (Pressing Mode on the remote controller also toggles between upper and lower cases)
  - "←" "→": Moves the cursor in the arrow direction.
  - "⊞": Removes a character on the left of the cursor.
  - "␣": Enters a space.
    - Pressing Clear on the remote controller will remove all the input characters.
3. After inputting, select "OK" with the cursors, and press Enter. The input name will be saved.

### □ AirPlay (Default Value: On)

Select whether or not to use the AirPlay function.

|     |                                |
|-----|--------------------------------|
| On  | When this function is used     |
| Off | When this function is not used |

### □ AirPlay Device Name (Default Value: Integra DRX-2.4 XXXXXX)

Change the model name of this unit which is displayed on the AirPlay-connected device to an easily recognized name.

1. Press Enter to display the Edit screen.
2. Select a character or symbol with the cursors, and press Enter. Repeat this operation to input up to 31 characters.
  - "A/a": Switches between upper and lower cases. (Pressing Mode on the remote controller also toggles between upper and lower cases)
  - "←" "→": Moves the cursor in the arrow direction.
  - "⊞": Removes a character on the left of the cursor.
  - "␣": Enters a space.
    - Pressing Clear on the remote controller will remove all the input characters.
3. After inputting, select "OK" with the cursors, and press Enter. The input name will be saved.
  - This function cannot be used when registering this unit to Home App.



## 6. Hardware

### AirPlay Password (Default Value: -)

You can set a password of up to 31 characters so that only users that have input can use AirPlay.

1. Press Enter to display the Edit screen.
2. Select a character or symbol with the cursors, and press Enter.  
Repeat this operation to input up to 31 characters.
  - "A/a": Switches between upper and lower cases. (Pressing Mode on the remote controller also toggles between upper and lower cases)
  - "←" "→": Moves the cursor in the arrow direction.
  - "⊞": Removes a character on the left of the cursor.
  - "␣": Enters a space.
    - To select whether to mask the password with "\*" or display it in plain text, press Memory on the remote controller.
    - Pressing Clear on the remote controller will remove all the input characters.
3. After inputting, select "OK" with the cursors, and press Enter.  
The input password will be saved.
  - This function cannot be used when registering this unit to Home App.

### Privacy Statement (Default Value: Not Accepted)

When using a network service that requires a login name, email address, password, etc., you need to agree to the Privacy Statement of our company.

- This setting can be made after confirming the Privacy Statement. When you select "Privacy Statement" and press Enter, the Privacy Statement is displayed.
- When "Not Accepted" is selected, you will log out from the network service you have logged in.

### Network Check (Default Value: -)

You can check the network connection.  
Press Enter when "Start" is displayed.

- Wait for a while if "Network" cannot be selected. It can be selected when the network function is activated.



## 6. Hardware

### ■ 3. Bluetooth

Change the settings for the BLUETOOTH function.

- Wait for a while if "Bluetooth" cannot be selected. It can be selected when the BLUETOOTH function is activated.

#### (Bluetooth Receiver)

##### Bluetooth Receiver (Default Value: On)

Select whether or not to use the function that receives audio from BLUETOOTH wireless technology enabled devices.

|     |                                |
|-----|--------------------------------|
| On  | When this function is used     |
| Off | When this function is not used |

##### Auto Input Change (Default Value: On)

When a BLUETOOTH enabled device is played while it is connected to the unit, the input of the unit can be automatically switched to "BLUETOOTH".

|     |                                                                                                                                                                             |
|-----|-----------------------------------------------------------------------------------------------------------------------------------------------------------------------------|
| On  | The input will automatically become "BLUETOOTH" when a BLUETOOTH enabled device is connected.                                                                               |
| Off | The function is disabled. <ul style="list-style-type: none"> <li>• If the input is not switched automatically, set this to "Off", and change the input manually.</li> </ul> |

##### Auto Reconnect (Default Value: On)

This function automatically reconnects to the BLUETOOTH enabled device connected last when you change the input to "BLUETOOTH".

- This may not work with some BLUETOOTH enabled devices.

|     |                                |
|-----|--------------------------------|
| On  | When this function is used     |
| Off | When this function is not used |

##### Pairing Information (Default Value: -)

You can initialize the pairing information stored on this unit. If you are no longer able to connect with a device you have paired, try doing this. ( →p140)

Pressing Enter when "Clear" is displayed initializes the pairing information stored on this unit.

- This function does not initialize the pairing information on the BLUETOOTH enabled device. When pairing the unit again with the device, be sure to clear the pairing information on the BLUETOOTH enabled device beforehand. For information on how to clear the pairing information, refer to the instruction manual of the BLUETOOTH enabled device.

##### Device (Default Value: -)

Displays the name of the BLUETOOTH enabled device connected to the unit.

- The name is not displayed when "Status" is "Ready" and "Pairing".

##### Status (Default Value: -)

Displays the status of the BLUETOOTH enabled device connected to the unit.

|           |                        |
|-----------|------------------------|
| Ready     | Not paired             |
| Pairing   | Paired                 |
| Connected | Successfully connected |

#### (Bluetooth Transmitter)

##### Bluetooth Transmitter (Default Value: Off)

Select whether or not to use the function that transmits audio from this unit to BLUETOOTH wireless technology enabled devices.

|     |                                |
|-----|--------------------------------|
| On  | When this function is used     |
| Off | When this function is not used |



## 6. Hardware

### ❑ Search Devices (Default Value: -)

Search for a BLUETOOTH wireless technology enabled device that is able to receive the audio from this unit. Select "Start" then press Enter. A list of the names of BLUETOOTH wireless technology enabled devices that are able to receive is displayed. Select the device to be connected with the cursors ▲ / ▼, then pairing begins when you press Enter.

### ❑ aptX HD (Default Value: Off)

It is possible to use aptX HD to connect a BLUETOOTH wireless technology enabled device and this unit.

- The codec of the receiving device must be compatible with aptX HD.

|     |                                |
|-----|--------------------------------|
| On  | When this function is used     |
| Off | When this function is not used |

### ❑ Low Latency Mode (Default Value: Off)

If the audio from a device connected via BLUETOOTH is delayed compared to the video on the TV when watching a gaming screen, etc., you can reduce the audio delay.

|     |                                |
|-----|--------------------------------|
| On  | When this function is used     |
| Off | When this function is not used |

### ❑ Pairing Information (Default Value: -)

You can initialize the pairing information stored on this unit. If you are no longer able to connect with a device you have paired, try doing this. ( → [p140](#))

Pressing Enter when "Clear" is displayed initializes the pairing information stored on this unit.

- This function does not initialize the pairing information on the BLUETOOTH enabled device. When pairing the unit again with the device, be sure to clear the pairing information on the BLUETOOTH enabled device in advance. For information on how to clear the pairing information, refer to the BLUETOOTH enabled device's instruction manual.

### ❑ Device (Default Value: -)

Displays the name of the BLUETOOTH enabled device connected to the unit.

- The name is not displayed when "Status" is "Ready" and "Pairing".

### ❑ Status (Default Value: -)

Displays the status of the BLUETOOTH enabled device connected to the unit.

|                     |                                                       |
|---------------------|-------------------------------------------------------|
| Ready               | Not paired                                            |
| Pairing             | Paired                                                |
| Connected           | Successfully connected                                |
| Connected (aptX)    | Successfully connected with aptX compatible device    |
| Connected (aptX HD) | Successfully connected with aptX HD compatible device |





## 6. Hardware

### ■ 4. Power Management

Change the settings for the power-save function.

#### □ Sleep Timer (Default Value: Off)

|                                          |                                                                                                                                                             |
|------------------------------------------|-------------------------------------------------------------------------------------------------------------------------------------------------------------|
| 30 minutes,<br>60 minutes,<br>90 minutes | You can allow the unit to enter standby automatically when the specified time has elapsed. Select a value from "30 minutes", "60 minutes" and "90 minutes". |
| Off                                      | Does not turn the unit to standby automatically.                                                                                                            |

#### □ Auto Standby (Default Value: On/Off)

This setting allows the unit to enter standby mode automatically after 20 minutes of inactivity without any video or audio input. (When "USB Power Out at Standby" or "Network Standby" is enabled, the unit enters the Hybrid Standby mode which minimizes the increase in power consumption.)

- Default values vary depending on the regions.

|     |                                                                                                                                                                                                                                                                                                           |
|-----|-----------------------------------------------------------------------------------------------------------------------------------------------------------------------------------------------------------------------------------------------------------------------------------------------------------|
| On  | The unit will automatically enter standby mode ("AUTO STBY" will light). <ul style="list-style-type: none"> <li>• "Auto Standby" is displayed on the main unit's display and TV screen 30 seconds before entering standby mode.</li> <li>• "Auto Standby" does not work when ZONE 2 is active.</li> </ul> |
| Off | The unit will not automatically enter standby mode.                                                                                                                                                                                                                                                       |

#### □ Auto Standby in HDMI Standby Through (Default Value: On/Off)

Enable or disable "Auto Standby" while "HDMI Standby Through" is on.

- Default values vary depending on the regions.

|     |                                                                                                                                                                                    |
|-----|------------------------------------------------------------------------------------------------------------------------------------------------------------------------------------|
| On  | The setting will be enabled. <ul style="list-style-type: none"> <li>• This setting cannot be set to "On" if "Auto Standby" and "HDMI Standby Through" are set to "Off".</li> </ul> |
| Off | The setting will be disabled.                                                                                                                                                      |

#### □ USB Power Out at Standby (Default Value: Off)

Devices connected to the USB port (5 V/1 A) on the rear of the unit can be supplied with electricity even when this unit is in standby mode when this function is "On".

- When this function is set to "On", the power consumption in standby state increases, however, the increase in power consumption is minimized by automatically entering the Hybrid Standby mode where only the essential circuits operate.

#### □ Network Standby (Default Value: On)

When this function is set to "On", the network function works even in standby state, and you can turn on the power of the unit via network using an application such as Integra Control Pro that can control this unit.

- When this function is set to "On", the power consumption in standby state increases, however, the increase in power consumption is minimized by automatically entering the Hybrid Standby mode where only the essential circuits operate. Note that even if this function is set to "Off", when any of the HDMI CEC (→p114), HDMI Standby Through (→p114), USB Power Out at Standby (→p121) and Bluetooth Wakeup (→p122) functions is enabled, this function will be in "On" state regardless of the setting.
- When connection to the network is lost, "Network Standby" may be disabled to reduce power consumption. In such a case, turn the unit on by using the power button on the remote controller or main unit.



## 6. Hardware

### Bluetooth Wakeup (Default Value: Off)

This function wakes up the unit on standby by connecting a BLUETOOTH enabled device.

|     |                                                                                                                                                                                                                                                                                                                               |
|-----|-------------------------------------------------------------------------------------------------------------------------------------------------------------------------------------------------------------------------------------------------------------------------------------------------------------------------------|
| On  | <p>When this function is used</p> <ul style="list-style-type: none"> <li>When this function is set to "On", the power consumption in standby state increases, however, the increase in power consumption is minimized by automatically entering the Hybrid Standby mode where only the essential circuits operate.</li> </ul> |
| Off | <p>When this function is not used</p> <ul style="list-style-type: none"> <li>This setting is fixed to "Off" if "Bluetooth" - "Bluetooth Receiver" is set to "Off".</li> <li>This setting is also fixed to "Off" if "Bluetooth" - "Bluetooth Receiver" - "Auto Input Change" is set to "Off".</li> </ul>                       |

- Wait for a while if "Network Standby" and "Bluetooth Wakeup" cannot be selected. It can be selected when the network function is activated.

### 5. 12V Trigger A

Set when outputting the control signal (maximum 12 V/100 mA) through the 12V TRIGGER OUT A jack. Different settings can be set for each input selector. You can enable power link operation when you connect the unit and the external devices equipped with 12V trigger input jack.

#### Delay (Default Value: 0sec)

Set after how many seconds the 12V trigger output will occur in response to the unit's operation. As some devices cause a large current when they turn on, delay the output if such devices are connected. Select a value between "0 sec" to "3 sec".

- BD/DVD (Default Value: Main)
- GAME (Default Value: Main)
- CBL/SAT (Default Value: Main)
- PC (Default Value: Main)
- STRM BOX (Default Value: Main)
- AUX (Default Value: Main)
- CD (Default Value: Main)
- TV (Default Value: Main)
- PHONO (Default Value: Main)
- TUNER (Default Value: Main)
- NET (Default Value: Main)
- BLUETOOTH (Default Value: Main)

Set the 12V trigger output setting to each input.

|             |                                                                                                            |
|-------------|------------------------------------------------------------------------------------------------------------|
| Off         | When the control signal is not output                                                                      |
| Main        | When controlling the power of external devices linked to the input selection in the main room              |
| Zone 2      | When controlling the power of external devices linked to the input selection in ZONE 2                     |
| Main/Zone 2 | When controlling the power of external devices linked to the input selection in the main room or in ZONE 2 |



## 6. Hardware

### 6. 12V Trigger B

Set when outputting the control signal (maximum 12 V/25 mA) through the 12V TRIGGER OUT B jack. Different settings can be set for each input selector. You can enable power link operation when you connect the unit and the external devices equipped with 12V trigger input jack.

#### Delay (Default Value: 1sec)

Set after how many seconds the 12V trigger output will occur in response to the unit's operation. As some devices cause a large current when they turn on, delay the output if such devices are connected. Select a value between "0 sec" to "3 sec".

- BD/DVD (Default Value: Zone 2)
- GAME (Default Value: Zone 2)
- CBL/SAT (Default Value: Zone 2)
- PC (Default Value: Zone 2)
- STRM BOX (Default Value: Zone 2)
- AUX (Default Value: Off)
- CD (Default Value: Zone 2)
- TV (Default Value: Zone 2)
- PHONO (Default Value: Zone 2)
- TUNER (Default Value: Zone 2)
- NET (Default Value: Zone 2)
- BLUETOOTH (Default Value: Zone 2)

Set the 12V trigger output setting to each input.

|             |                                                                                                            |
|-------------|------------------------------------------------------------------------------------------------------------|
| Off         | When the control signal is not output                                                                      |
| Main        | When controlling the power of external devices linked to the input selection in the main room              |
| Zone 2      | When controlling the power of external devices linked to the input selection in ZONE 2                     |
| Main/Zone 2 | When controlling the power of external devices linked to the input selection in the main room or in ZONE 2 |

### 7. 12V Trigger C

Set when outputting the control signal (maximum 12 V/25 mA) through the 12V TRIGGER OUT C jack. Different settings can be set for each input selector. You can enable power link operation when you connect the unit and the external devices equipped with 12V trigger input jack.

#### Delay (Default Value: 2sec)

Set after how many seconds the 12V trigger output will occur in response to the unit's operation. As some devices cause a large current when they turn on, delay the output if such devices are connected. Select a value between "0 sec" to "3 sec".

- BD/DVD (Default Value: Main/Zone 2)
- GAME (Default Value: Main/Zone 2)
- CBL/SAT (Default Value: Main/Zone 2)
- PC (Default Value: Main/Zone 2)
- STRM BOX (Default Value: Main/Zone 2)
- AUX (Default Value: Main)
- CD (Default Value: Main/Zone 2)
- TV (Default Value: Main/Zone 2)
- PHONO (Default Value: Main/Zone 2)
- TUNER (Default Value: Main/Zone 2)
- NET (Default Value: Main/Zone 2)
- BLUETOOTH (Default Value: Main/Zone 2)

Set the 12V trigger output setting to each input.

|             |                                                                                                            |
|-------------|------------------------------------------------------------------------------------------------------------|
| Off         | When the control signal is not output                                                                      |
| Main        | When controlling the power of external devices linked to the input selection in the main room              |
| Zone 2      | When controlling the power of external devices linked to the input selection in ZONE 2                     |
| Main/Zone 2 | When controlling the power of external devices linked to the input selection in the main room or in ZONE 2 |



## 6. Hardware

### ■ 8. Works with SONOS

Change the settings to connect with the Sonos Connect.

(SONOS-1/SONOS-2)

#### □ Input Selector (Default Value: Off)

Select the input selector to which the Sonos Connect is connected.

- Selecting "Off" disables the interlock function with Sonos.

#### □ Connected Device (Default Value: -)

Displays the Sonos Connect connected to the same network as the network of this unit. Press the Enter button to select the connected Sonos Connect.

- Products (e.g. Play:3 unequipped with an output terminal) other than the Sonos Connect are also displayed in the device list and selectable. In that case, when playback on the Sonos side starts, the input is switched, however, audio is not output. Select the room name of the connected Sonos Connect.
- Up to 32 devices can be displayed on the Sonos product list screen. If you cannot find the Sonos Connect to be interlocked, return to the previous screen, turn off the product you do not want to interlock, and try again.
- To use this function, set "Input Selector" beforehand.

#### □ Output Zone (Default Value: Main)

Select the zone where you want to listen to the music.

- To use this function, set "Input Selector" beforehand.

|             |                                                                   |
|-------------|-------------------------------------------------------------------|
| Main        | Outputs audio only to the main room (where this unit is located). |
| Zone 2      | Outputs audio only to the separate room (ZONE 2).                 |
| Main/Zone 2 | Outputs audio to both the main room and separate room.            |

#### □ Preset Volume (Default Value: Main=Last / Zone 2=Last)

You can set the volume beforehand for playing back the Sonos Connect. You can set volumes for the main room (where this unit is located) and separate room (ZONE 2) respectively. Select a value from "Last" (Volume level before entering standby mode), "Min", "0.5" to "99.5" and "Max".

- To use this function, set "Input Selector" beforehand.



## 7. Multi Zone

### ■ 1. Zone 2

Change the settings for Zone 2.

#### □ Output Level (Default Value: Fixed)

Select whether to adjust the volume on the integrated amplifier in the separate room or on this unit when outputting to Zone 2.

|          |                                                         |
|----------|---------------------------------------------------------|
| Fixed    | Adjust on the integrated amplifier in the separate room |
| Variable | Adjust on this unit                                     |

#### □ Maximum Volume (Default Value: Off)

Set the maximum value for Zone 2 to avoid too high volume. Select a value from "Off", "50" to "99".

#### □ Power On Volume (Default Value: Last)

Set the Zone 2 volume level of when this unit is turned on. Select a value from "Last" (Volume level when the unit was turned off), "Min", "0.5" to "99.5" and "Max".

- You cannot set a higher value than that of "Maximum Volume".

#### □ Sound Check (Default Value: -)

Output test tones to ZONE 2 to enjoy audio in a separate room (ZONE 2) in addition to the main room.

Press Enter while "Start" is being displayed. Operate by following the on-screen displays.

### ■ 2. Remote Play Zone

Change the settings for remote play.

#### □ Remote Play Zone (Default Value: Auto)

When playing with AirPlay or Spotify Connect, or when using the Music Server function to play remotely from your PC, you can set whether to play in the main room (where this unit is located) or in a separate room (ZONE 2).

|              |                                                                                                                                                                                                  |
|--------------|--------------------------------------------------------------------------------------------------------------------------------------------------------------------------------------------------|
| Auto         | When the main room input is NET, music is played in the main room. When the separate room input is NET and the main room input is other than NET, then the music is played in the separate room. |
| Main, Zone 2 | Select when limiting the play zone to a particular room. For example, when playing only in the separate room, select "Zone 2".                                                                   |

- This function may not work if playback is already proceeding with the same network function.



## 8. Miscellaneous

### ■ 1. Tuner

Change the settings for Tuner.

#### AM/FM Frequency Step (North American models) (Default Value: 10 kHz / 0.2 MHz)

Select a frequency step to suit your residential area.

Select "10 kHz/0.2 MHz" or "9 kHz/0.05 MHz".

- When this setting is changed, all radio presets are deleted.

#### AM Frequency Step (Australian and Asian models) (Default Value: 9 kHz)

Select a frequency step to suit your residential area.

Select "10 kHz" or "9 kHz".

- When this setting is changed, all radio presets are deleted.

### ■ 2. Remote ID

Change the remote controller ID.

#### Remote ID (Default Value: 1)

If multiple Integra/ONKYO products are installed in the same room, select the ID for the remote control used with this unit from "1", "2" and "3" to prevent interference between the unit and other Integra/ONKYO products. After changing the ID on the main unit, set the same ID on the remote controller as the main unit with the following procedure.

While pressing and holding the Mode button, press the following buttons for approx. 3 seconds.

- To change the remote controller ID to "1": Movie/TV
- To change the remote controller ID to "2": Music
- To change the remote controller ID to "3": Game

### ■ 3. Firmware Update

Change the settings for Firmware Update.

#### Update Notice (Default Value: Enable)

Availability of a firmware update is notified via network.

|         |                       |
|---------|-----------------------|
| Enable  | Notify updates        |
| Disable | Do not notify updates |

#### Version (Default Value: -)

The current firmware version is displayed.

#### Update via NET (Default Value: -)

Press Enter to select when updating the firmware via network.

- This setting cannot be selected if you do not have Internet access or there is no updatable firmware.

#### Update via USB (Default Value: -)

Press Enter to select when updating the firmware via USB.

- This setting cannot be selected if a USB storage device is not connected or there is no updatable firmware in the USB storage device.
- Wait for a while if "Firmware Update" cannot be selected. It can be selected when the network function is activated.

### ■ 4. Initial Setup

Make the initial setup from the setup menu.

- Wait for a while if "Initial Setup" cannot be selected. It can be selected when the network function is activated.



## 8. Miscellaneous

---

### ■ 5. Lock

Lock the Setup menu so that the settings cannot be changed.

#### □ Setup Parameter (Default Value: Unlocked)

Lock the Setup menu so that the settings cannot be changed.

|          |                       |
|----------|-----------------------|
| Locked   | The menu is locked.   |
| Unlocked | The menu is unlocked. |

### ■ 6. Factory Reset

All the settings are restored to factory defaults.

#### □ Factory Reset (Default Value: -)

All the settings are restored to factory defaults.

Select "Start" and press Enter.

- If "Factory Reset" is performed, your settings are restored to the default values. Be sure to note down your setting contents beforehand.



## Web Setup

### Menu operations

You can make the settings for the network function of this unit using an Internet browser on a PC, smartphone, etc.

1. Press  on the remote controller to display the Setup menu.
2. Select "6. Hardware" - "Network" with the cursors, and then take a note of the IP address displayed in "IP Address".
3. Start the Internet browser on your PC, smartphone, etc. and enter the IP address of this unit in the URL field.
4. The screen for entering the user name and password is displayed. Enter the following then click "OK".  
User name: admin (fixed)  
Password: admin (default value)
  - You can change the password after logging in.
  - Input is required again if you close the browser.
  - Take a note of the password so that you do not forget it. If you do forget it, reset the unit ( → [p134](#)) then log in again with the initial settings (admin).
5. Information for the unit (Web Setup screen) is displayed in the internet browser.



6. After changing the settings, select "Save" to save the settings.

#### Device Information

You can change the Friendly Name or AirPlay Device Name, set an AirPlay Password, etc.

Control4: Register this unit if you are using a Control4 system.

Firmware Update: Select the firmware file you have downloaded to your PC so you can update this unit.

#### Network Setting

Status: You can see information for the network such as the MAC address and IP address of this unit.

Network Connection: You can select a network connection method. If you select "Wireless", select an access point from "Wi-Fi Setup" to connect.

DHCP: You can change DHCP settings. If you select "Off", set "IP Address", "Subnet Mask", "Gateway" and "DNS Server" manually.

Proxy: Display and set the URL for the proxy server.





# Initial Setup with Auto Start-up Wizard

## Operations

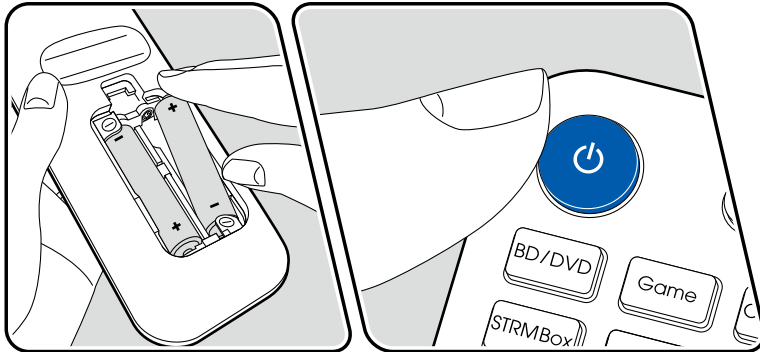
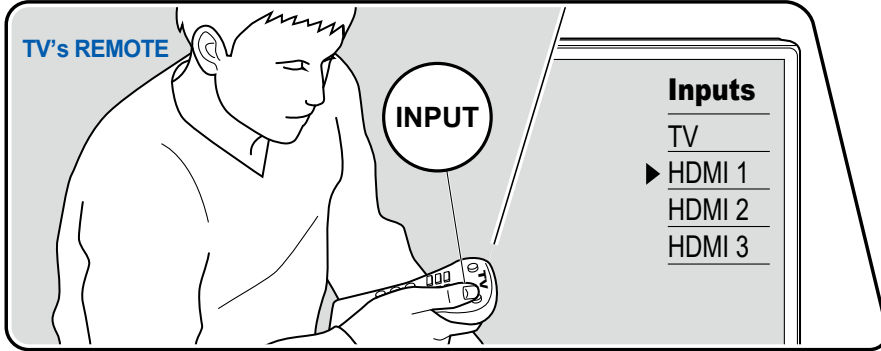

When you turn the unit on for the first time after purchase, the Initial Setup screen is automatically displayed on the TV to allow you to make settings required for startup using simple operations following on-screen guidance.

1. Switch the input of the TV to the input connected to the unit.
2. Put batteries into the remote controller of this unit.
3. Press **⏻** on the remote controller to turn the unit on.
4. When the language selection screen is displayed on TV, select the language with the cursors **▲ / ▼** and press **Enter**.
5. To make the network connection settings, select "Yes" and press **Enter**.
  - Select the item with the cursors of the remote controller, and press **Enter** to confirm your selection. To return to the previous screen, press **↶**.
  - If you have terminated the Initial Setup halfway, turn this unit to standby mode and turn the power on again. Then you can display the Initial Setup again. Unless you do the Initial Setup to the end or select "Never Show Again" in the screen shown after setting the Network Connection, the wizard screen is shown every time the power is turned on.
  - To perform the Initial Setup again after the setting is completed, press **⚙**, select "8. Miscellaneous" - "Initial Setup", and press **Enter**.

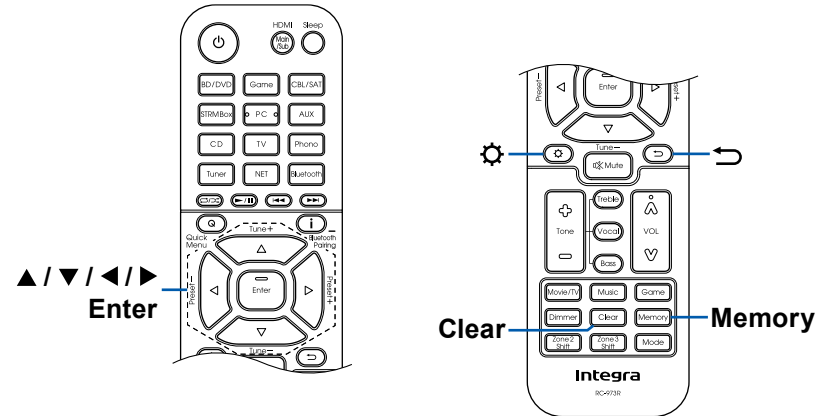

## Network Connection

1. A confirmation screen asking you whether to agree to the privacy statement is displayed during network setting. If you agree, select "Accept" and press Enter.
2. Select the type of connection to the network. To use the Chromecast built-in function to connect, select "Yes" and press Enter. The Google Home app is required to use the Chromecast built-in function. Download the Google Home app from Google Play or the App Store to your smart phone or tablet.
  - Google Home app can be used on the following operating systems. (As of April 2020)  
Android™: Android 4.4 or later.  
iOS: iOS 10.0 or later. Compatible with iPhone®, iPad®, and iPod touch®.

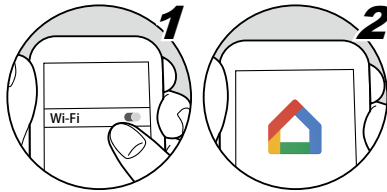

If you select "No", you can connect using either wired LAN or Wi-Fi.

**"Wired"**: Use a wired LAN to connect to a network.

**"Wireless"**: Wi-Fi connection using an access point such as a wireless LAN router.

- There are two methods for Wi-Fi connection.

**"Scan Networks"**: Search for an access point from this unit. Find out the SSID of the access point beforehand.

**"Use iOS Device (iOS7 or later)"**: Share the Wi-Fi settings of your iOS device with this unit.

- If you select "Scan Networks", there are another two types of connection methods. Check the following.

**"Enter Password"**: Enter the password (or key) of the access point to connect.

**"Push Button"**: If the access point is equipped with an automatic setting button, you can connect without entering the password.

- If the SSID of the access point is not displayed, select "Other..." with the cursor ► on the SSID list screen, press Enter, and then follow the on-screen instructions.



## Keyboard Input

To switch between upper and lower cases, select "A/a" on the screen, and press Enter on the remote controller.

To select whether to mask the password with "\*" or display it in plain text, press Memory on the remote controller. Pressing Clear on the remote controller will delete all the input characters.

### 1. Speaker Setup

1. Select the connected speaker configuration and press Enter.  
Note that the image on the screen changes each time you select the number of channels in "Speaker Channels".

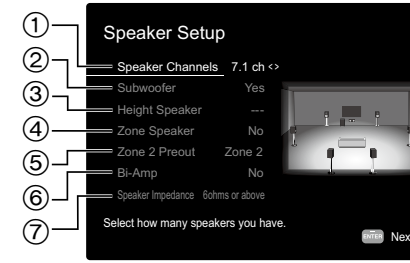

- ① Select to suit the number of speaker channels connected.
  - ② Set whether a subwoofer is connected or not.
  - ③ Set the speaker type if height speakers are connected to the HEIGHT terminals.
  - ④ Set the connection of speakers to Zone 2 speaker terminals.
  - ⑤ Set an output destination of the audio output from ZONE 2 PRE/LINE OUT/ZONE B LINE OUT jack.
  - ⑥ Set whether the front speakers are bi-amp connected.
  - ⑦ Set the impedance of the connected speakers.
2. The speaker combination selected in step 1 is displayed. "Yes" is displayed for the selected speakers. If the setting is correct, press Enter.
  3. Select "Next" and press Enter. Then a test tone is output from each speaker to confirm the connection. Selecting each speaker with the cursors ▲ / ▼ will output the test tone. Press Enter after confirmation.
  4. If there is no problem with the speaker connection, select "Next" and press Enter. To return to "Speaker Setup", select "Back to Speaker Setup" and press Enter.



## ■ 2. Multi Zone Sound Check

Output test tones to ZONE 2 to enjoy audio in a separate room (ZONE 2) in addition to the main room.

## ■ 3. ARC Setup

If you have connected a TV that supports ARC, select "Yes" and press Enter.

## ■ 4. AccuEQ Room Calibration

Place the supplied speaker setup microphone in the listening position, measure the test tones emitted by the speakers, then the unit automatically sets the optimum volume level for each speaker, the crossover frequencies, and the distance from the listening position. This also automatically adjusts the equalizers for the speakers, and enables correction of distortion caused by the acoustic environment of the room.

- It takes between 3 and 12 minutes for calibration to be completed. Each speaker outputs the test tone at high volume during measurement, so be careful of your surroundings. Also, keep the room as quiet as possible during measurement.
- If you connect a subwoofer, check the power and volume of the subwoofer. Set the subwoofer volume to more than half.
- If the power of this unit suddenly turns off, the wires in the speaker cables have touched the rear panel or other wires, and the protection circuit is working. Twist the wires again securely, and make sure they do not stick out of the speaker terminals when connecting.

1. Place the supplied speaker setup microphone at the listening position, and connect it to the Setup Mic jack on the main unit.

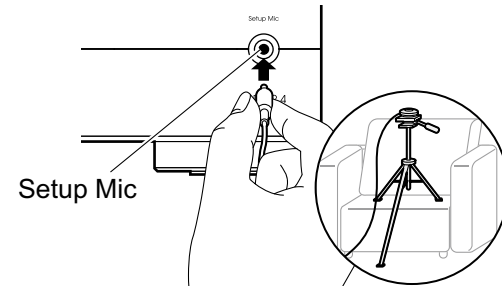

When placing the speaker setup microphone on a tripod, refer to the illustration.

2. Confirm a test tone is output from the subwoofer and press Enter.
3. Press Enter to output test tones from each speaker, and the connected speakers and the noise in the surrounding environment are automatically measured.
4. The measurement results in step 3 are displayed. If there is no problem in the detection result of the speaker, select "Next" and press Enter to output the test tone again to automatically set the settings such as volume level, crossover frequency, etc., to their optimum. (The test tone is automatically output when 10 seconds has elapsed without any operation.)
5. When the measurement is completed, the measurement results are displayed. You can check each setting using the cursors ◀/▶. Select "Save" and press Enter to save the settings.
6. Disconnect the speaker setup microphone.



# Integra Control Pro



Integra Control Pro (available on iOS and Android™ handsets) is a dedicated app available for free which allows you to use your handset as a remote controller. Along with basic operations such as switching input and adjusting the volume, you can also select a radio station or network service (internet radio or play of a music file) without looking at the TV.

- To use Integra Control Pro, this unit needs to be connected to the same network as the mobile device.

## Main features

- Turning the power on/off, switching input, adjusting the volume, and other such basic remote controller operations.
- When using Multi-zone ( → [p84](#) ), you can not only control with the app in the main room (where this unit is located), but also in the separate room (ZONE 2).
- Playing internet radio services (TuneIn Radio, etc.) and selecting stations. Control in the palm of your hands without looking at the TV.
- Play the music files saved on the mobile device via Wi-Fi.
- Play Amazon Music (compatible models only) ( → [p78](#) )

## Initial Setup

1. Download the Integra Control Pro from the App Store or Google Play™ Store.
2. Connect the mobile device to the same network as the unit.
3. Start Integra Control Pro. This unit is displayed automatically when the app is started, so tap the unit when displayed to select it.

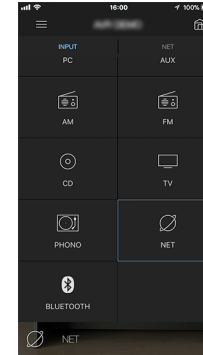

## Troubleshooting

### Before starting the procedure

Problems may be solved by simply turning the power on/off or disconnecting/connecting the power cord, which is easier than working on the connection, setting and operating procedure. Try the simple measures on both the unit and the connected device. If the problem is that the video or audio is not output or the HDMI linked operation does not work, disconnecting/connecting the HDMI cable may solve it. When reconnecting, be careful not to wind the HDMI cable since if wound the HDMI cable may not fit well. After reconnecting, turn off and on the unit and the connected device.

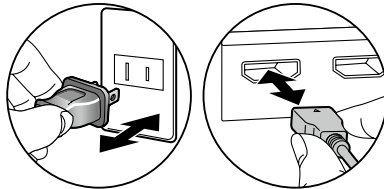

- The AV receiver contains a microPC for signal processing and control functions. In very rare situations, severe interference, noise from an external source, or static electricity may cause it to lockup. In the unlikely event that this happens, unplug the power cord from the wall outlet, wait at least 5 seconds, and then plug it back in.
- Our company is not responsible for damages (such as CD rental fees) due to unsuccessful recordings caused by the unit's malfunction. Before you record important data, make sure that the material will be recorded correctly.

### When the unit is operating erratically 134

Try restarting the unit 134

Resetting the unit (this resets the unit settings to the default) 134

### Troubleshooting 135

■ Power 135

■ Audio 135

|                        |     |
|------------------------|-----|
| ■ Listening Modes      | 137 |
| ■ Video                | 138 |
| ■ Linked operation     | 139 |
| ■ Tuner                | 139 |
| ■ BLUETOOTH function   | 139 |
| ■ Network function     | 141 |
| ■ USB storage device   | 142 |
| ■ Wireless LAN Network | 142 |
| ■ ZONE B function      | 143 |
| ■ Multi-zone function  | 143 |
| ■ Remote Controller    | 143 |
| ■ Display              | 143 |
| ■ Others               | 144 |



## When the unit is operating erratically

### ❑ Try restarting the unit

Restarting this unit may solve the problem. Set the main unit to standby, then after waiting for 5 seconds or more, press and hold the  On/Standby button of the main unit for at least 5 seconds, and then restart the unit. (The settings on this unit are kept.) If the problem persists after restarting the unit, unplug and plug the power cords or HDMI cable of this unit and connected devices.

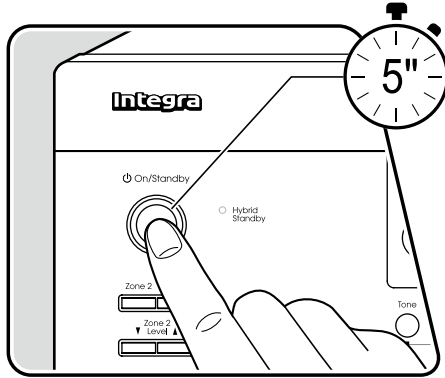

### ❑ Resetting the unit (this resets the unit settings to the default)

If the restart of the unit does not solve the problem, reset the unit, and restore all the settings to the factory default at the time of purchase. This may solve the problem. If the unit is reset, your settings are restored to the default values. Be sure to note down your setting contents before performing the following operations. Note that it is not possible to reset the unit during the Initial Setup process. Before doing the following procedures, press  to exit Initial Setup.

1. While pressing and holding CBL/SAT of the input selector on the main unit with the unit turned on, press the  On/Standby button.
2. "Clear" is displayed on the display, and the unit returns to the standby state.

Do not remove the power cord until "Clear" disappears from the display. To reset the remote controller, while pressing and holding Mode, press the Clear button at least 3 seconds.

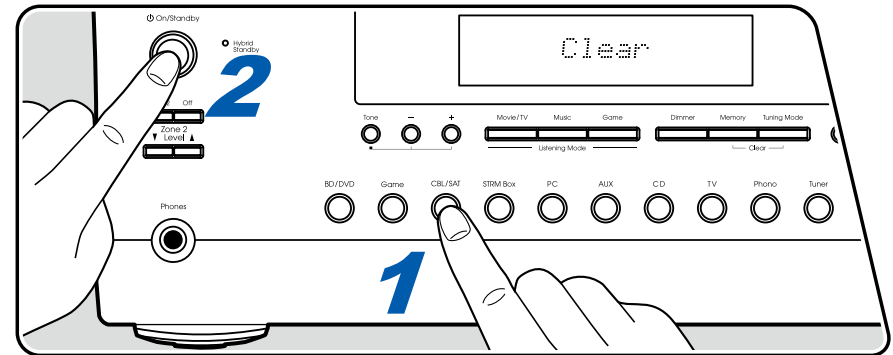

## Troubleshooting

### ■ Power

#### ❑ When the power is turned on, "AMP Diag Mode" appears on the display of the main unit.

- The protection circuit function may have operated. If the unit suddenly enters the standby state and "AMP Diag Mode" appears on the display of the main unit when the power is turned on again, this function is diagnosing whether or not the main unit is malfunctioning or there is an abnormality with the speaker cable connection. When the diagnosis is complete, the following messages are displayed.

|            |                                                                                                                                                                                                                                                                                                                                                      |
|------------|------------------------------------------------------------------------------------------------------------------------------------------------------------------------------------------------------------------------------------------------------------------------------------------------------------------------------------------------------|
| CH SP WIRE | If the unit returns to the normal ON state after "CH SP WIRE" appears on the display, the speaker cable may have been short-circuited. After setting the power of this unit to standby state, connect the speaker cable again. Twist the wires exposed from the tip of the speaker cable so that the wires do not stick out of the speaker terminal. |
| NG: *****  | If the operation has stopped with "NG" displayed on the display, set the power of this unit to standby state immediately and remove the power plug from the outlet. The unit may be malfunctioning. Consult a dealer.                                                                                                                                |

#### ❑ The unit turns off unexpectedly

- If "6. Hardware" - "Power Management" - "Auto Standby" on the Setup menu is activated, the unit automatically enters the standby mode. (→p121)
- The protection circuit function may have operated due to an abnormal rise in temperature of the unit. In such a case, the power turns off repeatedly even if the power is turned on each time. Secure sufficient ventilation space around the unit, wait for a while until the temperature of the unit decreases. Then, turn the power on again.

**WARNING:** If smoke, smell or abnormal noise is produced by the unit, unplug the power cord from the outlet immediately, and contact the dealer or our company's support.

### ■ Audio

- Make sure that the speaker setup microphone is no longer connected.
- Confirm that the connection between the output jack on the connected device and the input jack on this unit is correct.
- Make sure that none of the connecting cables are bent, twisted, or damaged.
- If "MUTING" is displayed on the display and is blinking, press  on the remote controller to cancel muting.
- While headphones are connected to the Phones jack, no sound is output from the speakers.
- When "4. Source" - "Audio Select" - "PCM Fixed Mode" on the Setup menu is set to "On", audio is not played if signals other than PCM are input. Change the setting to Off.

Check the following if the problem persists after you have confirmed the above.



## ❑ No sound from the TV

- Change the input selector on this unit to the position of the terminal to which the TV is connected.
- If the TV doesn't support the ARC function, along with connection by HDMI, connect the TV and this unit using a digital optical cable.

( →p48)

## ❑ No sound from a connected player

- Change the input selector on this unit to the position of the jack to which the player is connected.
- Check the digital audio output setting on the connected device. On some game consoles, such as those supporting DVD, the default setting may be off.
- For some DVD-Video discs, you need to select an audio output format from a menu.

## ❑ A speaker produces no sound

- Make sure that the polarity (+/-) of the speaker cables is correct, and that no bare wires are in contact with the metal part of speaker terminals.
- Make sure that the speaker cables are not shorting out.
- Check "Connect the Speaker Cables" ( →p31) to see if the speaker connections have been made correctly. Settings for the speaker connection environment need to be made in "Speaker Setup" in Initial Setup. Check "Initial Setup with Auto Start-up Wizard" ( →p129).
- Depending on the input signal and listening mode, not much sound may be output from speakers. Select another listening mode to see if sound is output.
- If surround back speakers are installed, be sure to install surround speakers as well.
- A maximum of 5.1 ch playback is possible when Bi-Amping connection is used. Be sure to remove the jumper bar on the speakers when using Bi-Amping connection.

( →p31)

## ❑ The subwoofer produces no sound

If the setting of the front speakers is "Full Band", the low range elements will be output from the front speakers instead of from the subwoofer during 2 ch audio input of TV or music. To output the sound from the subwoofer, make one of the following settings.

1. Change the setting for the front speakers to a setting of crossover frequency value other than "Full Band".  
The range below the specified frequency will be output from the subwoofer instead of from the front speakers. If your front speakers have a high low-range reproduction capability, changing this setting is not recommended.
  2. Change "Double Bass" to "On".  
The low range elements of the front speakers will be output from both the front speakers and the subwoofer. Due to this, the bass sound may be emphasized too much. In such a case, do not change the setting, or make the setting with the above option 1.
- For the setting details, refer to "2. Speaker" - "Crossover" on the Setup menu.
  - If the input signals do not contain subwoofer audio elements (LFE), the subwoofer may produce no sound.

( →p105)





## ❑ Noise can be heard

- Using cable ties to bundle audio pin cables, power cords, speaker cables, etc. may degrade the audio performance. Do not bundle the cords.
- An audio cable may be picking up interference. Change the position of the cables.

## ❑ The beginning of audio received by an HDMI IN cannot be heard

- Since it takes longer to identify the format of an HDMI signal than it does for other digital audio signals, audio output may not start immediately.

## ❑ Sound suddenly reduces

- When using the unit for extended periods with the temperature inside the unit exceeding a certain temperature, the volume may be reduced automatically to protect the circuits.

## ❑ Sound suddenly changes

- When "My Input Volume" is set, the volume is set for each input selector. Check "4. Source" - "My Input Volume" on the Setup menu ( → [p111](#)).

## ■ Listening Modes

- To enjoy digital surround playback in formats such as Dolby Digital, you need to make a connection for audio signals with an HDMI cable, digital coaxial cable or digital optical cable. Also, audio output need to be set to Bitstream output on the connected Blu-ray Disc player, etc.
- Press **i** on the remote controller several times to switch the display of the main unit, and you can check the input format.

Check the following if the problem persists after you have confirmed the above.

## ❑ Cannot select a desired listening mode

- Depending on the connection status of the speaker, some listening modes may not be selected. Check "Speaker Layouts and Selectable Listening Modes" ( → [p145](#)) or "Input Formats and Selectable Listening Modes" ( → [p150](#)).

## ❑ Cannot listen to the sound in Dolby TrueHD, Dolby Atmos or DTS-HD Master Audio format

- If the audio in Dolby TrueHD, Dolby Atmos or DTS-HD Master Audio format cannot be output correctly in the source format, set "BD video supplementary sound" (or reencode, secondary sound, video additional audio, etc.) to "Off" in the setting of a connected Blu-ray Disc player, etc. After changing the setting, switch the listening mode to that for each source, and confirm.

## ❑ About Dolby signals

- When surround back speakers are included in the speaker layout, and software that is recorded with the 5.1-channel Dolby audio format is played, the surround channel audio may be output from the surround back speakers.
- Some Dolby Atmos audio format that is used on games, etc., may be recognized as "Multichannel PCM". If this occurs, check the firmware updates for the game console.



## ❑ About DTS signals

- With media that switches suddenly from DTS to PCM, PCM playback may not start immediately. In such a case, stop playback on the player side for approx. 3 seconds or more. Then, resume playback. The playback will be performed normally.
- DTS playback may not be performed normally on some CD and LD players even if the player and this unit are digitally connected. If some processing (e.g., output level adjustment, sampling frequency conversion, or frequency characteristic conversion) has been executed for the DTS signal being output, this unit cannot recognize it as a genuine DTS signal, and noise may occur.
- While playing a DTS-compatible disc, if a pause or skip operation is performed on your player, noise may occur for a short period. This is not a malfunction.

## ■ Video

- Confirm that the connection between the output jack on the connected device and the input jack on this unit is correct.
- Make sure that none of the connecting cables are bent, twisted, or damaged.
- When the TV image is blurry or unclear, the power cord or connection cables of the unit may have interfered. In such a case, keep distance between TV antenna cable and cables of the unit.
- Check the switching of the input screen on the monitor side such as a TV.

Check the following if the problem persists after you have confirmed the above.

## ❑ No image appears

- Change the input selector on this unit to the position of the jack to which the player is connected.

## ❑ No image from a device connected to HDMI IN jack

- To display video from the connected player on the TV while the unit is in standby, you need to enable "6. Hardware" - "HDMI" - "HDMI Standby Through" on the Setup menu. For details of the HDMI Standby Through function, check "6. Hardware" - "HDMI" on the Setup menu. (→p114)
- To output video to a TV connected to the HDMI OUT SUB jack, press the Q button on the remote controller to display "Quick Menu" and select "HDMI" - "HDMI Out", or press the HDMI Main/Sub button on the remote controller and select the HDMI OUT jack.
- Check if "Resolution Error" is displayed on the main unit display when video input via HDMI IN jack is not displayed. In this case, the TV does not support the resolution of the video input from the player. Change the setting on the player.
- Normal operation with an HDMI-DVI adapter is not guaranteed. In addition, video signals output from a PC are not guaranteed.
- Try switching off the Deep Color function. To turn off the Deep Color function, simultaneously press the STRM Box and ⏻ On/Standby buttons on the main unit. While holding down STRM Box, press ⏻ On/Standby repeatedly until "Deep Color:Off" appears on the display. To reactivate the Deep Color function, repeat the above described step until "Deep Color:On" is appeared on the display.



## ❑ Images flicker

- The output resolution of the player may not be compatible with the resolution of the TV. If the player is connected to this unit with an HDMI cable, change the output resolution on the player. Also this may be solved by changing the screen mode on the TV.

## ❑ Video and audio are out of synch

- Depending on the settings on your TV and connection environment, the video may be behind the audio. Press Q on the remote controller to display "Quick Menu", select "HDMI" - "A/V Sync", and make the adjustment. ( →p71)

## ■ Linked operation

### ❑ HDMI linked operation does not work with CEC-compliant devices, such as a TV

- In the Setup menu of the unit, set "6. Hardware" - "HDMI" - "HDMI CEC" to "On". ( →p114)
- It is also necessary to set HDMI linking on the CEC-compliant device. Check the instruction manual.
- When connecting a Sharp brand player or recorder to the HDMI IN jacks, set "6. Hardware" - "HDMI" - "HDMI Standby Through" to "Auto" on the Setup menu.

## ■ Tuner

### ❑ Poor reception or much noise

- Recheck the antenna connection. ( →p54)
- Move the antenna away from the speaker cord or power cord.
- Move the unit away from your TV or PC.
- Passing cars or airplanes in the vicinity can cause interference.
- If radio waves are blocked by concrete walls, etc., radio reception may be poor.
- Change the reception mode to mono ( →p65).
- When listening to an AM station, operating the remote controller may cause noise.
- FM reception may be clearer if you use the antenna jack on the wall used for the TV.

## ■ BLUETOOTH function

- Unplug and plug the power cord of the unit, or turn off and on the BLUETOOTH enabled device. Restart of the BLUETOOTH enabled device may be effective.
- BLUETOOTH enabled devices must support the A2DP profile.
- Because a radio wave interference will occur, this unit may not be used near devices such as a microwave oven or cordless phone which use the radio wave in the 2.4 GHz range.
- A metallic object near the unit can affect on the radio wave, and BLUETOOTH connection may not be possible.

Check the following if the problem persists after you have confirmed the above.



## ❑ Cannot connect a BLUETOOTH wireless technology enabled device (PC, smartphone, etc.) to this unit

- Check if the BLUETOOTH function of the BLUETOOTH enabled device is enabled. (→[p119](#))

- Initialize the pairing information and perform pairing again.

Firstly delete all the pairing information saved on this unit. In the Setup menu, select "6. Hardware" - "Bluetooth" - "Bluetooth Receiver" - "Pairing Information", then press Enter while "Clear" is displayed.

Next, delete the pairing information of this unit that is saved on the BLUETOOTH wireless technology enabled device. For information on how to clear the pairing information, refer to the BLUETOOTH enabled device's instruction manual.

Finally, perform pairing again. Refer to "Playing audio from BLUETOOTH wireless technology enabled devices with this unit" (→[p61](#)) for pairing instructions.

## ❑ Cannot connect this unit to a BLUETOOTH wireless technology enabled device (wireless headphones, etc.)

- Check if the BLUETOOTH function of the BLUETOOTH enabled device is enabled. (→[p120](#))

- Initialize the pairing information and perform pairing again.

Firstly delete all the pairing information saved on this unit. In the Setup menu, select "6. Hardware" - "Bluetooth" - "Bluetooth Transmitter" - "Pairing Information", then press Enter while "Clear" is displayed.

Next, delete the pairing information of this unit that is saved on the BLUETOOTH wireless technology enabled device. For information on how to clear the pairing information, refer to the BLUETOOTH enabled device's instruction manual.

Finally, perform pairing again. Refer to "Transmitting audio from this unit to BLUETOOTH wireless technology enabled devices" (→[p62](#)) for pairing instructions.

## ❑ Music playback is unavailable on the unit even after successful BLUETOOTH connection

- When the audio volume of your BLUETOOTH enabled device is set low, the audio may not be played back. Turn up the volume of the BLUETOOTH enabled device.
- Depending on the BLUETOOTH enabled device, the Send/Receive selector switch may be equipped. Select Send mode.
- Depending on the characteristics or specifications of the BLUETOOTH enabled device, music may not be played back on this unit.

## ❑ Sound is interrupted

- There maybe a problem with the BLUETOOTH enabled device. Check the information on a web page.

## ❑ The audio quality is poor after connection with a BLUETOOTH enabled device

- The BLUETOOTH reception is poor. Move the BLUETOOTH enabled device closer to the unit, or remove any obstacle between the BLUETOOTH enabled device and this unit.



## ■ Network function

- If you cannot select a network service, start up the network function to select it. It may take approx. one minute to start it up.
- When the NET indicator is blinking, this unit is not properly connected to the home network.
- Unplug and plug the power cords of this unit and the router, or restart the router.
- If the desired router is not displayed in the access point list, it may be set to hide SSID, or the ANY connection may be off. Change the setting and try again.

Check the following if the problem persists after you have confirmed the above.

### □ Cannot access the Internet radio

- In the case the service provider has terminated the service, the network service or contents may not be used on this unit.
- Check if your modem and router are properly connected, and they are both turned on.
- Check if the LAN side port on the router is properly connected to this unit.
- Check if connecting to Internet from other devices is possible. If it is not possible, turn off all devices connected to the network, wait for a while, and then turn on the devices again.
- Depending on ISP, setting the proxy server is required.
- Check if the router and modem you are using are supported by your ISP.

### □ Cannot access the network server

- This unit needs to be connected to the same router as the network server.
- This unit supports the Windows Media® Player 12 network servers, or NASes that support the home network function.
- Windows Media® Player may require some settings. Refer to "Music Server".
- When using a PC, only the music files registered in the library of Windows Media® Player can be played.

( →p91)

### □ Sound is interrupted when playing music files on the network server

- Check if the network server meets the requirements for operation.
- When the PC is serving as the network server, quit application software other than the server software (Windows Media® Player 12, etc.).
- If the PC is downloading or copying large files, the playback sound may be interrupted.



## ■ USB storage device

### ❑ USB storage device is not displayed

- Check if the USB storage device or USB cable is securely inserted to the USB port of the unit.
- Disconnect the USB storage device once from the unit, and then reconnect it.
- Performance of the hard disk that receive power from the USB port of the unit is not guaranteed.
- Depending on the type of content, the playback may not be performed normally. Check the types of supported file formats.
- Operations of USB storage devices equipped with security functions are not guaranteed.

( →p88)

## ■ Wireless LAN Network

- Unplug and plug the power cords of this unit and the wireless LAN router, check the power-on status of the wireless LAN router, or restart the wireless LAN router.

Check the following if the problem persists after you have confirmed the above.

### ❑ Cannot access wireless LAN network

- The wireless LAN router setting may be switched to Manual. Restore the setting to Auto.
- Try the manual set-up. The connection may succeed.
- When the wireless LAN router is in stealth mode (mode to hide SSID) or when the ANY connection is off, the SSID is not displayed. Change the setting and try again.
- Check if the SSID and encryption settings (WEP, etc.) are correct. Match the network settings with the settings of this unit.
- Connection to an SSID that includes multi-byte characters is not supported. Set the SSID of the wireless LAN router using single-byte alphanumeric characters only, and try again.

### ❑ Connected to an SSID different from the selected SSID

- Some wireless LAN routers allow you to set multiple SSIDs for one unit. If connecting to such a router using the automatic setting button, you may end up connecting to an SSID different from the SSID you want to connect to. If this occurs, use the connection method requiring you to enter a password.

### ❑ Playback sound is interrupted, or communication is not possible

- You may not receive radio waves due to poor radio wave conditions. Shorten the distance from the wireless LAN router, or remove obstacles to improve visibility, and connect again. Install the unit away from microwave ovens or other access points. It is recommended to install the wireless LAN router and the unit in the same room.
- If there is a metallic object near the unit, wireless LAN connection may not be possible because the metal affects the radio wave.
- When other wireless LAN devices are used near the unit, other symptoms may occur, such as interrupted playback and impossible communication. You can avoid those problems by changing the channel of your wireless LAN router. For instructions on changing channels, refer to the instruction manual supplied with your wireless LAN router.
- There may not be enough bandwidth available in wireless LAN. Use a wired LAN for connection.



## ■ ZONE B function

### ❑ Cannot output audio to ZONE B

- To output audio to ZONE B, set the audio output destination for "Audio" - "Zone B" on Quick menu to "On (A+B)" or "On (B)" and also set "2. Speaker" - "Configuration" - "Zone 2 Preout" on the Setup menu to "Zone B".

( →p96)

## ■ Multi-zone function

### ❑ Cannot ZONE-output the audio of externally connected AV components

- To output audio from an externally connected AV component to ZONE 2, connect it to any of HDMI IN1 to IN3 jacks. If the AV component is not equipped with an HDMI jack, use a digital coaxial cable, digital optical cable or analog audio cable. Also, the audio from externally connected AV components can be output to ZONE 2 only when the audio is analog or 2 ch PCM signal. When the AV component is connected to this unit with an HDMI cable, digital coaxial cable or digital optical cable, change the audio output of the AV component to the PCM output.
- When video and audio via HDMI input are output to ZONE 2, set "1. Input/Output Assign" - "TV Out / OSD" - "Zone 2 HDMI" ( →p101) to "Use" on the Setup menu.

### ❑ Others

- If the audio signal is from the NET input selector, the zone output is not possible for DSD audio signals.

## ■ Remote Controller

- Make sure that the batteries are inserted with the correct polarity.
- Insert new batteries. Do not mix different types of batteries, or old and new batteries.
- Make sure that the sensor of the main unit is not subjected to direct sunlight or inverter-type fluorescent lights. Relocate it if necessary.
- If the main unit is installed in a rack or cabinet with colored-glass doors, or if the doors are closed, the remote controller may not work normally.

## ■ Display

### ❑ The display does not light up

- When the Dimmer function is working, the display may go dim. Press the Dimmer button, and change the brightness level of the display.

( →p16)



## ■ Others

### ❑ Strange noise can be heard from the unit

- If you have connected another device to the same outlet as this unit, strange noise may occur under the influence of the device. If the symptom is remedied by removing the power plug of the other device from the outlet, use different outlets for this unit and the device.

### ❑ The message "Noise Error" appears during AccuEQ Room Calibration

- This can be caused by a malfunction in your speaker unit. Check the speaker output, etc.

### ❑ The measurement results of AccuEQ Room Calibration show different distances to the speakers from the actual ones

- Depending on the speakers you are using, some errors may occur in the measurement results. If this is the case, make the settings in "2. Speaker" - "Distance" in the Setup menu.

( →p106)

### ❑ The measurement results of AccuEQ Room Calibration show that the volume level of the subwoofer has been corrected to the lower limit

- The volume level correction of the subwoofer may not have been completed. Lower the volume of the subwoofer before AccuEQ Room Calibration measurement.





## Speaker Layouts and Selectable Listening Modes

See the following table for selectable listening modes for each speaker layout.

| Listening mode                                                             | Speaker layout (ch) |       |       |       |       |       |       |       |       |       |
|----------------------------------------------------------------------------|---------------------|-------|-------|-------|-------|-------|-------|-------|-------|-------|
|                                                                            | 2.1                 | 3.1   | 4.1   | 5.1   | 6.1   | 7.1   | 2.1.2 | 3.1.2 | 4.1.2 | 5.1.2 |
| <input checked="" type="checkbox"/> DD (Dolby Audio - DD)                  |                     | ✓(*1) | ✓(*1) | ✓(*1) | ✓(*2) | ✓(*2) |       | ✓(*2) | ✓(*2) | ✓(*2) |
| <input checked="" type="checkbox"/> DD+ (Dolby Audio - DD+)                |                     | ✓(*1) | ✓(*1) | ✓(*1) | ✓(*1) | ✓(*1) | ✓(*1) | ✓(*1) | ✓(*1) | ✓(*1) |
| <input checked="" type="checkbox"/> DTHD (Dolby Audio - TrueHD)            |                     | ✓(*1) | ✓(*1) | ✓(*1) | ✓(*1) | ✓(*1) | ✓(*1) | ✓(*1) | ✓(*1) | ✓(*1) |
| <input checked="" type="checkbox"/> Atmos                                  |                     |       |       |       | ✓     | ✓     | ✓     | ✓     | ✓     | ✓     |
| <input checked="" type="checkbox"/> Atmos 2.0/2.1                          | ✓                   |       |       |       |       |       |       |       |       |       |
| <input checked="" type="checkbox"/> Atmos 3.0/3.1                          |                     | ✓     |       |       |       |       |       |       |       |       |
| <input checked="" type="checkbox"/> Atmos 4.0/4.1                          |                     |       | ✓     |       |       |       |       |       |       |       |
| <input checked="" type="checkbox"/> Atmos 5.0/5.1                          |                     |       |       | ✓     |       |       |       |       |       |       |
| <input checked="" type="checkbox"/> Atmos 6.0/6.1                          |                     |       |       |       | ✓     |       |       |       |       |       |
| <input checked="" type="checkbox"/> Atmos 7.0/7.1                          |                     |       |       |       |       | ✓     |       |       |       |       |
| <input checked="" type="checkbox"/> Atmos 2.0.2/2.1.2                      |                     |       |       |       |       |       | ✓     |       |       |       |
| <input checked="" type="checkbox"/> Atmos 3.0.2/3.1.2                      |                     |       |       |       |       |       |       | ✓     |       |       |
| <input checked="" type="checkbox"/> DSurr (Dolby Audio - Surr)             | ✓                   | ✓     | ✓     | ✓     | ✓     | ✓     | ✓     | ✓     | ✓     | ✓     |
| <input checked="" type="checkbox"/> DSurr 2.0/2.1 (Dolby Audio - Surr)     | ✓                   |       |       |       |       |       |       |       |       |       |
| <input checked="" type="checkbox"/> DSurr 3.0/3.1 (Dolby Audio - Surr)     |                     | ✓     |       |       |       |       |       |       |       |       |
| <input checked="" type="checkbox"/> DSurr 4.0/4.1 (Dolby Audio - Surr)     |                     |       | ✓     |       |       |       |       |       |       |       |
| <input checked="" type="checkbox"/> DSurr 5.0/5.1 (Dolby Audio - Surr)     |                     |       |       | ✓     |       |       |       |       |       |       |
| <input checked="" type="checkbox"/> DSurr 6.0/6.1 (Dolby Audio - Surr)     |                     |       |       |       | ✓     |       |       |       |       |       |
| <input checked="" type="checkbox"/> DSurr 7.0/7.1 (Dolby Audio - Surr)     |                     |       |       |       |       | ✓     |       |       |       |       |
| <input checked="" type="checkbox"/> DSurr 2.0.2/2.1.2 (Dolby Audio - Surr) |                     |       |       |       |       |       | ✓     |       |       |       |
| <input checked="" type="checkbox"/> DSurr 3.0.2/3.1.2 (Dolby Audio - Surr) |                     |       |       |       |       |       |       | ✓     |       |       |



| Listening mode                      | Speaker layout (ch) |     |     |     |     |     |       |       |       |       |
|-------------------------------------|---------------------|-----|-----|-----|-----|-----|-------|-------|-------|-------|
|                                     | 2.1                 | 3.1 | 4.1 | 5.1 | 6.1 | 7.1 | 2.1.2 | 3.1.2 | 4.1.2 | 5.1.2 |
| DTS                                 |                     | ✓   | ✓   | ✓   | ✓   | ✓   |       | ✓(*3) | ✓(*3) | ✓(*3) |
| ES Discrete (DTS-ES Discrete)       |                     |     |     |     | ✓   | ✓   |       |       |       |       |
| ES Matrix (DTS-ES Matrix)           |                     |     |     |     | ✓   | ✓   |       |       |       |       |
| DTS 96/24                           |                     | ✓   | ✓   | ✓   | ✓   | ✓   |       | ✓(*3) | ✓(*3) | ✓(*3) |
| DTS-HD HR (DTS-HD High Resolution)  |                     | ✓   | ✓   | ✓   | ✓   | ✓   |       | ✓     | ✓     | ✓     |
| DTS-HD Master (DTS-HD Master Audio) |                     | ✓   | ✓   | ✓   | ✓   | ✓   |       | ✓     | ✓     | ✓     |
| DTS Express                         |                     | ✓   | ✓   | ✓   | ✓   | ✓   |       | ✓     | ✓     | ✓     |
| DTS:X                               |                     | ✓   | ✓   | ✓   | ✓   | ✓   | ✓     | ✓     | ✓     | ✓     |
| DTS Neural:X                        | ✓                   | ✓   | ✓   | ✓   | ✓   | ✓   | ✓     | ✓     | ✓     | ✓     |
| DTS Virtual:X                       | ✓                   | ✓   | ✓   | ✓   | ✓   | ✓   |       |       |       |       |



| Listening mode            | Speaker layout (ch) |       |       |       |       |       |       |       |       |       |
|---------------------------|---------------------|-------|-------|-------|-------|-------|-------|-------|-------|-------|
|                           | 2.1                 | 3.1   | 4.1   | 5.1   | 6.1   | 7.1   | 2.1.2 | 3.1.2 | 4.1.2 | 5.1.2 |
| Multich (Multichannel)    |                     | ✓(*1) | ✓(*1) | ✓(*1) | ✓(*1) | ✓(*1) |       | ✓(*3) | ✓(*3) | ✓(*3) |
| DSD                       |                     | ✓(*1) | ✓(*1) | ✓(*1) | ✓(*2) | ✓(*2) |       | ✓(*2) | ✓(*2) | ✓(*2) |
| Direct                    | ✓                   | ✓(*1) | ✓(*1) | ✓(*1) | ✓(*1) | ✓(*1) | ✓(*1) | ✓(*1) | ✓(*1) | ✓(*1) |
| Stereo                    | ✓                   | ✓(*4) | ✓(*4) | ✓(*4) | ✓(*4) | ✓(*4) | ✓(*4) | ✓(*4) | ✓(*4) | ✓(*4) |
| Mono                      | ✓                   | ✓(*4) | ✓(*4) | ✓(*4) | ✓(*4) | ✓(*4) | ✓(*4) | ✓(*4) | ✓(*4) | ✓(*4) |
| Orchestra                 |                     |       | ✓     | ✓     | ✓     | ✓     | ✓     | ✓     | ✓     | ✓     |
| Unplugged                 |                     |       | ✓     | ✓     | ✓     | ✓     | ✓     | ✓     | ✓     | ✓     |
| Studio-Mix                |                     |       | ✓     | ✓     | ✓     | ✓     | ✓     | ✓     | ✓     | ✓     |
| TV Logic                  |                     |       | ✓     | ✓     | ✓     | ✓     | ✓     | ✓     | ✓     | ✓     |
| Game-RPG                  |                     |       | ✓     | ✓     | ✓     | ✓     | ✓     | ✓     | ✓     | ✓     |
| Game-Action               |                     |       | ✓     | ✓     | ✓     | ✓     | ✓     | ✓     | ✓     | ✓     |
| Game-Rock                 |                     |       | ✓     | ✓     | ✓     | ✓     | ✓     | ✓     | ✓     | ✓     |
| Game-Sports               |                     |       | ✓     | ✓     | ✓     | ✓     | ✓     | ✓     | ✓     | ✓     |
| AllCh Stereo              |                     | ✓     | ✓     | ✓     | ✓     | ✓     | ✓     | ✓     | ✓     | ✓     |
| Mono Music                |                     | ✓     | ✓     | ✓     | ✓     | ✓     | ✓     | ✓     | ✓     | ✓     |
| T-D (Theater-Dimensional) | ✓                   | ✓     | ✓(*4) | ✓(*5) | ✓(*4) | ✓(*5) | ✓(*4) | ✓(*5) | ✓(*4) | ✓(*5) |

\*1: Reproduced with the sound field according to the number of channels of input signals.

\*2: Not output from surround back speakers or height speakers.

\*3: Not output from height speakers.

\*4: Output only from front speakers.

\*5: Output only from front speakers and center speaker.



## Listening Mode buttons and Selectable Listening Modes

Refer to the following table for the listening modes that can be selected with each listening mode button.

| Listening mode                                                             | Listening Mode buttons |       |      |
|----------------------------------------------------------------------------|------------------------|-------|------|
|                                                                            | Movie/TV               | Music | Game |
| <input checked="" type="checkbox"/> DD (Dolby Audio - DD)                  | ✓                      | ✓     | ✓    |
| <input checked="" type="checkbox"/> DD+ (Dolby Audio - DD+)                | ✓                      | ✓     | ✓    |
| <input checked="" type="checkbox"/> DTHD (Dolby Audio - TrueHD)            | ✓                      | ✓     | ✓    |
| <input checked="" type="checkbox"/> Atmos                                  | ✓                      | ✓     | ✓    |
| <input checked="" type="checkbox"/> Atmos 2.0/2.1                          | ✓                      | ✓     | ✓    |
| <input checked="" type="checkbox"/> Atmos 3.0/3.1                          | ✓                      | ✓     | ✓    |
| <input checked="" type="checkbox"/> Atmos 4.0/4.1                          | ✓                      | ✓     | ✓    |
| <input checked="" type="checkbox"/> Atmos 5.0/5.1                          | ✓                      | ✓     | ✓    |
| <input checked="" type="checkbox"/> Atmos 6.0/6.1                          | ✓                      | ✓     | ✓    |
| <input checked="" type="checkbox"/> Atmos 7.0/7.1                          | ✓                      | ✓     | ✓    |
| <input checked="" type="checkbox"/> Atmos 2.0.2/2.1.2                      | ✓                      | ✓     | ✓    |
| <input checked="" type="checkbox"/> Atmos 3.0.2/3.1.2                      | ✓                      | ✓     | ✓    |
| <input checked="" type="checkbox"/> DSurr (Dolby Audio - Surr)             | ✓                      | ✓     | ✓    |
| <input checked="" type="checkbox"/> DSurr 2.0/2.1 (Dolby Audio - Surr)     | ✓                      | ✓     | ✓    |
| <input checked="" type="checkbox"/> DSurr 3.0/3.1 (Dolby Audio - Surr)     | ✓                      | ✓     | ✓    |
| <input checked="" type="checkbox"/> DSurr 4.0/4.1 (Dolby Audio - Surr)     | ✓                      | ✓     | ✓    |
| <input checked="" type="checkbox"/> DSurr 5.0/5.1 (Dolby Audio - Surr)     | ✓                      | ✓     | ✓    |
| <input checked="" type="checkbox"/> DSurr 6.0/6.1 (Dolby Audio - Surr)     | ✓                      | ✓     | ✓    |
| <input checked="" type="checkbox"/> DSurr 7.0/7.1 (Dolby Audio - Surr)     | ✓                      | ✓     | ✓    |
| <input checked="" type="checkbox"/> DSurr 2.0.2/2.1.2 (Dolby Audio - Surr) | ✓                      | ✓     | ✓    |
| <input checked="" type="checkbox"/> DSurr 3.0.2/3.1.2 (Dolby Audio - Surr) | ✓                      | ✓     | ✓    |

| Listening mode                      | Listening Mode buttons |       |      |
|-------------------------------------|------------------------|-------|------|
|                                     | Movie/TV               | Music | Game |
| DTS                                 | ✓                      | ✓     | ✓    |
| ES Discrete (DTS-ES Discrete)       | ✓                      | ✓     | ✓    |
| ES Matrix (DTS-ES Matrix)           | ✓                      | ✓     | ✓    |
| DTS 96/24                           | ✓                      | ✓     | ✓    |
| DTS-HD HR (DTS-HD High Resolution)  | ✓                      | ✓     | ✓    |
| DTS-HD Master (DTS-HD Master Audio) | ✓                      | ✓     | ✓    |
| DTS Express                         | ✓                      | ✓     | ✓    |
| DTS:X                               | ✓                      | ✓     | ✓    |
| DTS Neural:X                        | ✓                      | ✓     | ✓    |
| DTS Virtual:X                       | ✓                      | ✓     | ✓    |

| Listening mode         | Listening Mode buttons |       |      |
|------------------------|------------------------|-------|------|
|                        | Movie/TV               | Music | Game |
| Multich (Multichannel) | ✓                      | ✓     | ✓    |
| PCM                    | ✓                      | ✓     | ✓    |
| DSD                    | ✓                      | ✓     | ✓    |
| Direct                 | ✓                      | ✓     | ✓    |
| Stereo                 |                        | ✓     |      |
| Mono                   | ✓                      |       |      |



| Listening mode            | Listening Mode buttons |       |      |
|---------------------------|------------------------|-------|------|
|                           | Movie/TV               | Music | Game |
| Orchestra                 |                        | ✓     |      |
| Unplugged                 |                        | ✓     |      |
| Studio-Mix                |                        | ✓     |      |
| TV Logic                  | ✓                      |       |      |
| Unplugged                 |                        | ✓     |      |
| Game-RPG                  |                        |       | ✓    |
| Game-Action               |                        |       | ✓    |
| Game-Rock                 |                        |       | ✓    |
| Game-Sports               |                        |       | ✓    |
| AllCh Stereo              | ✓                      | ✓     | ✓    |
| Mono Music                |                        | ✓     |      |
| T-D (Theater-Dimensional) | ✓                      |       | ✓    |



# Input Formats and Selectable Listening Modes

You can select a variety of listening modes according to the audio format of the signal to be input.

- Selectable listening modes when headphones are connected are Mono, Direct, and Stereo only.

| Input format                                            | Listening mode |                            |                                  |                                  |             |                                 |
|---------------------------------------------------------|----------------|----------------------------|----------------------------------|----------------------------------|-------------|---------------------------------|
|                                                         | Direct Stereo  | DD (Dolby Audio - DD) (*2) | DD+ (Dolby Audio - DD+) (*2)(*3) | DTHD (Dolby Audio - TrueHD) (*2) | Atmos (*12) | DSur (Dolby Audio - Surr) (*11) |
| <b>2-channel signal input</b>                           |                |                            |                                  |                                  |             |                                 |
| Analog / PCM                                            | ✓              |                            |                                  |                                  |             | ✓                               |
| Music file / DSD (*1)                                   | ✓              |                            |                                  |                                  |             | ✓                               |
| DD / DD+ / DTHD                                         | ✓              |                            |                                  |                                  |             | ✓                               |
| DTS / DTS 96/24 / DTS Express / DTS-HD HR / DTS-HD MSTR | ✓              |                            |                                  |                                  |             | ✓(*13)                          |
| <b>Multi-channel signal input</b>                       |                |                            |                                  |                                  |             |                                 |
| Multich PCM                                             | ✓              |                            |                                  |                                  |             | ✓                               |
| DSD (*1)                                                | ✓              |                            |                                  |                                  |             | ✓                               |
| DD                                                      | ✓              | ✓                          |                                  |                                  |             | ✓                               |
| DD+                                                     | ✓              |                            | ✓                                |                                  |             | ✓                               |
| DTHD                                                    | ✓              |                            |                                  | ✓                                |             | ✓                               |
| ATMOS                                                   | ✓              |                            |                                  |                                  | ✓           |                                 |
| DTS                                                     | ✓              |                            |                                  |                                  |             | ✓                               |
| DTS 96/24                                               | ✓              |                            |                                  |                                  |             | ✓                               |
| DTS Express                                             | ✓              |                            |                                  |                                  |             |                                 |
| DTS-HD HR                                               | ✓              |                            |                                  |                                  |             | ✓                               |
| DTS-HD MSTR                                             | ✓              |                            |                                  |                                  |             | ✓                               |
| DTS-ES Discrete                                         | ✓              |                            |                                  |                                  |             | ✓                               |
| DTS-ES Matrix                                           | ✓              |                            |                                  |                                  |             | ✓                               |
| DTS:X                                                   | ✓              |                            |                                  |                                  |             |                                 |



| Listening mode<br>Input format                          | DTS (*2)                      | DTS 96/24 (*2) | DTS Express (*2) | DTS-HD HR (DTS-HD High Resolution) (*2) | DTS-HD Master (DTS-HD Master Audio) (*2) | ES Discrete (DTS-ES Discrete) (*5) | ES Matrix (DTS-ES Matrix) (*5) | DTS:X | DTS Neural:X (*6) | DTS Virtual:X (*9) (*10) |
|---------------------------------------------------------|-------------------------------|----------------|------------------|-----------------------------------------|------------------------------------------|------------------------------------|--------------------------------|-------|-------------------|--------------------------|
|                                                         | <b>2-channel signal input</b> |                |                  |                                         |                                          |                                    |                                |       |                   |                          |
| Analog / PCM                                            |                               |                |                  |                                         |                                          |                                    |                                |       | ✓                 | ✓                        |
| Music file / DSD (*1)                                   |                               |                |                  |                                         |                                          |                                    |                                |       | ✓                 | ✓                        |
| DD / DD+ / DTHD                                         |                               |                |                  |                                         |                                          |                                    |                                |       | ✓                 | ✓                        |
| DTS / DTS 96/24 / DTS Express / DTS-HD HR / DTS-HD MSTR |                               |                |                  |                                         |                                          |                                    |                                |       | ✓                 | ✓                        |
| <b>Multi-channel signal input</b>                       |                               |                |                  |                                         |                                          |                                    |                                |       |                   |                          |
| Multich PCM                                             |                               |                |                  |                                         |                                          |                                    |                                |       | ✓                 | ✓                        |
| DSD (*1)                                                |                               |                |                  |                                         |                                          |                                    |                                |       | ✓                 | ✓                        |
| DD                                                      |                               |                |                  |                                         |                                          |                                    |                                |       | ✓                 | ✓                        |
| DD+                                                     |                               |                |                  |                                         |                                          |                                    |                                |       | ✓                 | ✓                        |
| DTHD                                                    |                               |                |                  |                                         |                                          |                                    |                                |       | ✓                 | ✓                        |
| ATMOS                                                   |                               |                |                  |                                         |                                          |                                    |                                |       |                   |                          |
| DTS                                                     | ✓                             |                |                  |                                         |                                          |                                    |                                |       | ✓                 | ✓                        |
| DTS 96/24                                               |                               | ✓              |                  |                                         |                                          |                                    |                                |       | ✓                 | ✓                        |
| DTS Express                                             |                               |                | ✓                |                                         |                                          |                                    |                                |       | ✓                 | ✓                        |
| DTS-HD HR                                               |                               |                |                  | ✓                                       |                                          |                                    |                                |       | ✓                 | ✓                        |
| DTS-HD MSTR                                             |                               |                |                  |                                         | ✓                                        |                                    |                                |       | ✓                 | ✓                        |
| DTS-ES Discrete                                         | ✓(*4)                         |                |                  |                                         |                                          | ✓                                  |                                |       | ✓                 | ✓                        |
| DTS-ES Matrix                                           | ✓(*4)                         |                |                  |                                         |                                          |                                    | ✓                              |       | ✓                 | ✓                        |
| DTS:X                                                   |                               |                |                  |                                         |                                          |                                    |                                | ✓     |                   | ✓                        |



| Listening mode<br>Input format                                | PCM<br>(Multich<br>PCM) (*2) | DSD<br>(*2)(*11) | Mono | Orchestra/ Unplugged/<br>Studio-Mix/ TV Logic/ Game-<br>Action/ Game-Rock/Game-<br>RPG/ Game-Sports (*7) | AllCh<br>Stereo /<br>Mono Music<br>(*8) | T-D (Theater-<br>Dimensional)<br>(*9) |
|---------------------------------------------------------------|------------------------------|------------------|------|----------------------------------------------------------------------------------------------------------|-----------------------------------------|---------------------------------------|
| <b>2-channel signal input</b>                                 |                              |                  |      |                                                                                                          |                                         |                                       |
| Analog / PCM                                                  |                              |                  | ✓    | ✓                                                                                                        | ✓                                       | ✓                                     |
| Music file / DSD (*1)                                         |                              |                  |      | ✓                                                                                                        | ✓                                       | ✓                                     |
| DD / DD+ / DTHD                                               |                              |                  |      | ✓                                                                                                        | ✓                                       | ✓                                     |
| DTS / DTS 96/24 / DTS<br>Express / DTS-HD HR /<br>DTS-HD MSTR |                              |                  |      | ✓                                                                                                        | ✓                                       | ✓                                     |
| <b>Multi-channel signal input</b>                             |                              |                  |      |                                                                                                          |                                         |                                       |
| Multich PCM                                                   | ✓                            |                  |      | ✓                                                                                                        | ✓                                       | ✓                                     |
| DSD (*1)                                                      |                              | ✓                |      | ✓                                                                                                        | ✓                                       | ✓                                     |
| DD                                                            |                              |                  |      | ✓                                                                                                        | ✓                                       | ✓                                     |
| DD+                                                           |                              |                  |      | ✓                                                                                                        | ✓                                       | ✓                                     |
| DTHD                                                          |                              |                  |      | ✓                                                                                                        | ✓                                       | ✓                                     |
| ATMOS                                                         |                              |                  |      | ✓                                                                                                        | ✓                                       | ✓                                     |
| DTS                                                           |                              |                  |      | ✓                                                                                                        | ✓                                       | ✓                                     |
| DTS 96/24                                                     |                              |                  |      | ✓                                                                                                        | ✓                                       | ✓                                     |
| DTS Express                                                   |                              |                  |      | ✓                                                                                                        | ✓                                       | ✓                                     |
| DTS-HD HR                                                     |                              |                  |      | ✓                                                                                                        | ✓                                       | ✓                                     |
| DTS-HD MSTR                                                   |                              |                  |      | ✓                                                                                                        | ✓                                       | ✓                                     |
| DTS-ES Discrete                                               |                              |                  |      | ✓                                                                                                        | ✓                                       | ✓                                     |
| DTS-ES Matrix                                                 |                              |                  |      | ✓                                                                                                        | ✓                                       | ✓                                     |
| DTS:X                                                         |                              |                  |      | ✓                                                                                                        | ✓                                       | ✓                                     |





- (\*1) You cannot select any mode other than Stereo, AllCh Stereo and Mono Music if the sampling rate is 5.6/11.2 MHz.
- (\*2) A center speaker or surround speakers need to be installed.
- (\*3) If the input source is Blu-ray Disc and the speaker layout is 5.1 ch or less, DD+ cannot be selected. Instead, the listening mode for DD can be selected.
- (\*4) This can only be selected when no surround back speaker is connected.
- (\*5) Surround back speakers need to be installed.
- (\*6) If the input format is any of the following and the number of channels is monaural, this listening mode becomes unavailable.
  - DTS, DTS 96/24, DTS Express, DTS-HD HR, DTS-HD MSTR, PCM, music file
- (\*7) Surround speakers or height speakers need to be installed.
- (\*8) A center speaker, surround speakers, or height speakers need to be installed.
- (\*9) Cannot be selected if "Speaker Virtualizer" ( →[p108](#)) is set to "Off".
- (\*10) This cannot be selected when height speakers are connected.
- (\*11) Cannot be selected when the input format is monaural.
- (\*12) The listening mode displayed depends on the speaker layout ( →[p145](#)). Furthermore, when the setting for "Speaker Virtualizer" ( →[p108](#)) is "Off" (the default value is On), then modes other than  Atmos and  DSur cannot be selected.
- (\*13) This cannot be selected when the input format is DTS Express.

## Speaker Layouts and Selectable Listening Modes ( →[p145](#))



## Listening Mode Effects

### In alphabetical order

#### ■ AllCh Stereo









This mode is ideal for background music. Stereo sound is played through the surround speakers as well as the front speakers, creating a stereo image.

#### ■ Atmos

Since this mode calculates the positional data of audio recorded in Dolby Atmos audio in real-time and outputs it from appropriate speakers, you can enjoy the natural and stereophonic sound field of Dolby Atmos with any speaker layout including connection of only front speakers. Also, the Dolby Atmos sound design can be reproduced more faithfully by connecting surround back speakers or height speakers. You can select this mode when inputting the Dolby Atmos audio format.

Unlike existing surround systems, Dolby Atmos does not rely on channels, but rather enables the accurate placement of sound objects that have independent motion in a 3D space with even greater clarity. Dolby Atmos is an optional audio format for Blu-ray Discs and achieves a more stereophonic sound field by introducing a sound field above the listener.

According to the speaker layout, the following listening modes are displayed.

-  Atmos 2.0/2.1: When only front speakers are installed
-  Atmos 3.0/3.1: When front speakers and center speaker are installed
-  Atmos 4.0/4.1: When front speakers and surround speakers are installed
-  Atmos 5.0/5.1: When front speakers, center speaker and surround speakers are installed
-  Atmos 6.0/6.1: When front speakers, surround speakers and surround back speakers are installed
-  Atmos 7.0/7.1: When front speakers, center speaker, surround speakers and surround back speakers are installed
-  Atmos 2.0.2/2.1.2: When front speakers and height speakers are installed
-  Atmos 3.0.2/3.1.2: When front speakers, center speaker and height speakers are installed
-  Atmos: Selectable in the "4.1.2 ch" or "5.1.2 ch" setting with surround speakers and height speakers installed.

- To enable transfer of this audio format, connect via an HDMI cable and set the audio output on the player to Bitstream output.
- When "Speaker Virtualizer" ( →p108) is set to "Off" (Default: On), modes other than  Atmos cannot be selected.

#### ■ DD (Dolby Audio - DD)

This mode faithfully reproduces the sound design recorded in the Dolby Digital audio format.

Dolby Digital is a multi-channel digital format developed by Dolby Laboratories, Inc. and is widely adopted for use in movie production. It is also a standard audio format for DVD-Video and Blu-ray Discs. It is possible to record a maximum of 5.1 channels on a DVD-Video or Blu-ray Disc; two front channels, one center channel, two surround channels, and the LFE channel dedicated to the bass region (sound elements for the subwoofer).

- To enable transfer of this audio format, connect via a digital cable and set the audio output on the player to Bitstream output.

#### ■ DD+ (Dolby Audio - DD+)

This mode faithfully reproduces the sound design recorded in the Dolby Digital Plus audio format.

The Dolby Digital Plus format has been improved based on Dolby Digital, increasing the number of channels and endeavoring to improve sound quality by giving more flexibility in data bit rates. Dolby Digital Plus is an optional audio format based on 5.1 ch for Blu-ray Discs. It is possible to record a maximum of 7.1 channels with additional channels such as the surround back channel.

- To enable transfer of this audio format, connect via an HDMI cable and set the audio output on the player to Bitstream output.

#### ■ Direct

This listening mode can be selected for all input signals. Processing that affects sound quality is shut down, and sound closer to the original is reproduced. The sound is reproduced with the sound field based on the number of channels in the input signal. For example, a 2 ch signal is output only from the front speakers.











Note that the sound adjustment is not available when this mode is selected.



## ■ DSur (Dolby Audio - Surr)

This listening mode expands 2 ch or 5.1 ch input signals to 5.1 ch, 7.1 ch or 5.1.2 ch. This mode expands actual channels to more channels for playback according to the configuration of the connected speakers. Also, even if there is no speaker for expansion, for example when only front speakers are connected, audio of surround channel or height channel is virtually created for expansion playback.

According to the speaker layout, the following listening modes are displayed.

-  DSur 2.0/2.1: When only front speakers are installed
  -  DSur 3.0/3.1: When front speakers and center speaker are installed
  -  DSur 4.0/4.1: When front speakers and surround speakers are installed
  -  DSur 5.0/5.1: When front speakers, center speaker and surround speakers are installed
  -  DSur 6.0/6.1: When front speakers, surround speakers and surround back speakers are installed
  -  DSur 7.0/7.1: When front speakers, center speaker, surround speakers and surround back speakers are installed
  -  DSur 2.0.2/2.1.2: When front speakers and height speakers are installed
  -  DSur 3.0.2/3.1.2: When front speakers, center speaker and height speakers are installed
  -  DSur: Selectable in the "4.1.2 ch" or "5.1.2 ch" setting with surround speakers and height speakers installed.
- When "Speaker Virtualizer" ( → [p108](#)) is set to "Off" (Default: On), modes other than  DSur cannot be selected.

## ■ DTHD (Dolby Audio - TrueHD)

This mode faithfully reproduces the sound design recorded in the Dolby TrueHD audio format.

The Dolby TrueHD audio format is a "lossless" format expanded based on the lossless compression technology referred to as MLP, and it faithfully reproduces the master audio recorded in the studio. Dolby TrueHD is an optional audio format based on 5.1 ch for Blu-ray Discs. It is possible to record a maximum of 7.1 channels with additional channels such as the surround back channel. 7.1 ch is recorded at 96 kHz/24 bit, and 5.1 ch is recorded at 192 kHz/24 bit.

- To enable transfer of this audio format, connect via an HDMI cable and set the audio output on the player to Bitstream output.

## ■ DSD

This mode is suitable for playing sources recorded in DSD.

- This unit supports the DSD signal input from the HDMI input terminal. However, depending on the connected player, better sound may be obtained by setting the output on the player side to the PCM output.
- This listening mode cannot be selected if the output setting on your Blu-ray Disc/DVD player is not set to DSD.

## ■ DTS

This mode faithfully reproduces the sound design recorded in the DTS audio format.

The DTS audio format is a multi-channel digital format developed by DTS, Inc. This format is an optional audio format for DVD-Video and a standard format for Blu-ray Discs. It enables recording of 5.1 channels; two front channels, one center channel, two surround channels, and the LFE channel dedicated to the bass region (sound elements for the subwoofer). The content is recorded with a rich volume of data, with a maximum sampling rate of 48 kHz, at a resolution of 24 bits and a bit rate of 1.5 Mbps.

- To enable transfer of this audio format, connect via a digital cable and set the audio output on the player to Bitstream output.

## ■ DTS 96/24

This mode faithfully reproduces the sound design recorded in the DTS 96/24 audio format.

The DTS 96/24 format is an optional audio format for DVD-Video and Blu-ray Discs. It enables recording of 5.1 channels; two front channels, one center channel, two surround channels, and the LFE channel dedicated to the bass region (sound elements for the subwoofer). Detailed reproduction is achieved by recording the content at a sampling rate of 96 kHz and at a resolution of 24 bits.

- To enable transfer of this audio format, connect via a digital cable and set the audio output on the player to Bitstream output.



## ■ DTS Express

This mode faithfully reproduces the sound design recorded in the DTS Express audio format.

DTS Express is an optional audio format based on 5.1 ch for Blu-ray Discs. It is possible to record a maximum of 7.1 channels with additional channels such as the surround back channel. It also supports low bit rates.

- To enable transfer of this audio format, connect via an HDMI cable and set the audio output on the player to Bitstream output.

## ■ DTS-HD HR (DTS-HD High Resolution)

This mode faithfully reproduces the sound design recorded in the DTS-HD High Resolution Audio audio format.

DTS-HD High Resolution Audio is an optional audio format based on 5.1 ch for Blu-ray Discs. It is possible to record a maximum of 7.1 channels with additional channels such as the surround back channel at a sampling rate of 96 kHz and at a resolution of 24 bits.

- To enable transfer of this audio format, connect via an HDMI cable and set the audio output on the player to Bitstream output.

## ■ DTS-HD MSTR (DTS-HD Master Audio)

This mode faithfully reproduces the sound design recorded in the DTS-HD Master Audio audio format.

DTS-HD Master Audio is an optional audio format based on 5.1 ch for Blu-ray Discs. It is possible to record a maximum of 7.1 channels with additional channels such as the surround back channel using the lossless audio reproduction technology. 96 kHz/24 bit is supported for 7.1 ch, and 192 kHz/24 bit is supported for 5.1 ch.

- To enable transfer of this audio format, connect via an HDMI cable and set the audio output on the player to Bitstream output.

## ■ DTS Neural:X

This listening mode expands actual channels to more channels for playback to suit the configuration of the connected speakers by expanding the input signals from 2 channels or 5.1 channels to 5.1 channels or 7.1 channels respectively.

## ■ DTS Virtual:X

DTS Virtual:X listening mode uses the proprietary audio processing technology

to create spacious 3D sound including audio from up above without connecting height speakers.

This mode can be selected in any speaker layout such as front speakers-only connection. You can enjoy your favorite movies or TV programs with a more immersive audio experience.

- This mode cannot be selected when height speakers are connected.
- This mode cannot be selected when "Speaker Virtualizer" ( →[p108](#)) is set to "Off" (Default: On).

## ■ DTS:X

This mode faithfully reproduces the sound design recorded in the DTS:X audio format.

The DTS:X audio format is a combination of the mixing method based on traditional channel based formats (5.1 ch and 7.1 ch) and object based dynamic audio mixing, and it is characterized by the precise positioning of sounds and the ability to express sound movement.

- To enable transfer of this audio format, connect via an HDMI cable and set the audio output on the player to Bitstream output.

## ■ ES Discrete (DTS-ES Discrete)

This mode faithfully reproduces the sound design recorded in the DTS-ES Discrete audio format.

DTS-ES Discrete is an optional audio format based on 5.1 ch for DVD-Video and Blu-ray Discs. It is possible to record a maximum of 6.1 channels with a monaural surround back channel added.

- To enable transfer of this audio format, connect via a digital cable and set the audio output on the player to Bitstream output.

## ■ ES Matrix (DTS-ES Matrix)

This mode faithfully reproduces the sound design recorded in the DTS-ES Matrix audio format.

DTS-ES Matrix is an optional audio format based on 5.1 ch for DVD-Video and Blu-ray Discs. A monaural surround back channel is inserted to this format by matrix encoding. During playback, 6.1 channel-playback is achieved by the matrix decoder on this unit.

- To enable transfer of this audio format, connect via a digital cable and set the audio output on the player to Bitstream output.



## ■ Game-Action

This mode is suitable for games with a lot of action.

## ■ Game-Rock

This mode is suitable for games with rock content.

## ■ Game-RPG

This mode is suitable for role-playing games.

## ■ Game-Sports

This mode is suitable for sports games.

## ■ Mono

In this mode, monaural audio is played from the center speaker at the time of inputting an analog signal or PCM signal. If there is no center speaker connected, monaural audio is played from the front speakers.

## ■ Mono Music

In this mode, all speakers output the same sound in mono, so the sound you hear is the same regardless of where you are within the listening room.

## ■ Multich (Multichannel)

This mode is suitable to play sources recorded in multichannel PCM.

## ■ Orchestra

This mode is suitable for classical or operatic music. This mode emphasizes the surround channels in order to widen the sound image, and simulates the natural reverberation of a large hall.

## ■ Stereo

In this mode, sound is output from the right and left front speakers and subwoofer.

## ■ Studio-Mix

This mode is suitable for rock or pop music. This mode creates a lively sound field with a powerful acoustic image as if you are at a club or rock concert.

## ■ T-D (Theater-Dimensional)

In this mode, you can enjoy a virtual playback of multichannel surround sound even with only two or three speakers. This works by controlling how sounds reach the listener's left and right ears.

- This mode cannot be selected when "Speaker Virtualizer" (→[p108](#)) is set to "Off" (Default: On).

## ■ TV Logic

Suitable for TV shows produced in a TV studio. This mode gives clarity to voices by enhancing the entire surround sounds, and creates a realistic acoustic image.

## ■ Unplugged

Suitable for acoustic instruments, vocals and jazz. This mode emphasizes the front sound field image, giving the impression of being in front of the stage.



## Speaker Combinations

- Up to two powered subwoofers can be connected in either combination.

| Speaker Channels | FRONT | CENTER | SURROUND | SURROUND BACK | HEIGHT | Bi-AMP      | ZONE 2 (ZONE SPEAKER) |
|------------------|-------|--------|----------|---------------|--------|-------------|-----------------------|
| 2.1 ch           | ✓     |        |          |               |        | ✓ (*1)      | ✓ (*1)                |
| 3.1 ch           | ✓     | ✓      |          |               |        | ✓ (*1)      | ✓ (*1)                |
| 4.1 ch           | ✓     |        | ✓        |               |        | ✓ (*1)      | ✓ (*1)                |
| 5.1 ch           | ✓     | ✓      | ✓        |               |        | ✓ (*1)      | ✓ (*1)                |
| 6.1 ch           | ✓     |        | ✓        | ✓ (*2)        |        |             | ✓                     |
| 7.1 ch           | ✓     | ✓      | ✓        | ✓ (*2)        |        |             | ✓                     |
| 2.1.2 ch         | ✓     |        |          |               | ✓ (*3) | ✓ (*1) (*3) | ✓ (*1)                |
| 3.1.2 ch         | ✓     | ✓      |          |               | ✓ (*3) | ✓ (*1) (*3) | ✓ (*1)                |
| 4.1.2 ch         | ✓     |        | ✓        |               | ✓ (*4) |             | ✓                     |
| 5.1.2 ch         | ✓     | ✓      | ✓        |               | ✓ (*4) |             | ✓                     |

(\*1) You can select either Bi-AMP or ZONE SPEAKER.

(\*2) When audio is being output from the ZONE SPEAKER, surround back speakers cannot play audio.

(\*3) When using Bi-Amp speakers, it is necessary to connect the Bi-Amp speakers to the HEIGHT terminals, and height speakers to the SURROUND terminals.

(\*4) When audio is being output from the ZONE SPEAKER, height speakers cannot play audio.



## General Specifications

| Amplifier Section                                        | North American models                                                                                                                                                                                 | Australian and Asian models                                   |
|----------------------------------------------------------|-------------------------------------------------------------------------------------------------------------------------------------------------------------------------------------------------------|---------------------------------------------------------------|
| Rated Output Power                                       | With 8 ohm loads, both channels driven, from 20-20,000 Hz; rated 80 watts per channel minimum RMS power, with no more than 0.08% total harmonic distortion from 250 milliwatts to rated output. (FTC) | 7 ch × 135 W at 6 ohms, 1 kHz, 1 ch driven of 1% THD (IEC)    |
| Maximum Effective Output Power                           | 170 W at 6 ohms, 1 kHz, 1 ch driven of 10% THD                                                                                                                                                        | 7 ch × 160 W at 6 ohms, 1 kHz, 1 ch driven of 10% THD (JEITA) |
| Dynamic Power (IEC60268-Short-term maximum output power) | 160 W (3 Ω, Front), 125 W (4 Ω, Front), 85 W (8 Ω, Front)                                                                                                                                             |                                                               |
| THD+N (Total Harmonic Distortion + Noise)                | 0.08% (20 Hz - 20,000 Hz, Rated output power)                                                                                                                                                         |                                                               |
| Input Sensitivity and Impedance                          | 200 mV/47 kΩ (LINE(RCA)), 3.5 mV/47 kΩ (PHONO MM)                                                                                                                                                     |                                                               |
| Rated RCA Output Level and Impedance                     | PRE OUT (SUBWOOFER) : 1 V/470 Ω                                                                                                                                                                       |                                                               |
|                                                          | ZONE B LINE OUT, ZONE 2 PRE/LINE OUT (*) : 200 mV/470 Ω<br>*1 V/470 Ω if changed to PRE OUT (FRONT)                                                                                                   |                                                               |
| Phono Maximum Input Signal Voltage                       | 70 mV (MM 1 kHz 0.5%)                                                                                                                                                                                 |                                                               |
| Frequency Response                                       | 10 Hz - 100 kHz/+1 dB, -3 dB (Direct)                                                                                                                                                                 |                                                               |
| Tone Control Characteristics                             | ±10 dB, 20 Hz (Bass), ±10 dB, 20 kHz (Treble)                                                                                                                                                         |                                                               |
| Signal to Noise Ratio                                    | 106 dB (IHF-A, LINE IN, SP OUT), 80 dB (IHF-A, PHONO IN, SP OUT)                                                                                                                                      |                                                               |
| Speaker Impedance                                        | 4 Ω - 16 Ω                                                                                                                                                                                            |                                                               |
| Headphone Rated Output                                   | 80 mW + 80 mW (32 Ω, 1 kHz, 10% THD)                                                                                                                                                                  |                                                               |
| Supported impedance of Headphones                        | 8 Ω - 600 Ω                                                                                                                                                                                           |                                                               |
| Headphones Frequency Response                            | 10 Hz - 100 kHz                                                                                                                                                                                       |                                                               |



| <b>Tuner Section</b>                 | <b>North American models</b>                 | <b>Australian and Asian models</b> |
|--------------------------------------|----------------------------------------------|------------------------------------|
| FM Tuning Frequency Range            | 87.5 MHz - 107.9 MHz                         | 87.5 MHz - 108.0 MHz, RDS          |
| 50 dB quieting sensitivity (FM MONO) | 1.0 $\mu$ V, 11.2 dBf (IHF, 1 kHz, 100% MOD) |                                    |
| AM Tuning Frequency Range            | 530 kHz - 1710 kHz                           | 522/530 kHz - 1611/1710 kHz        |
| Preset Channel                       | 40                                           |                                    |

| <b>BLUETOOTH Section</b>      | <b>North American models</b>                                                                                                                                                                                                                                                                   | <b>Australian and Asian models</b> |
|-------------------------------|------------------------------------------------------------------------------------------------------------------------------------------------------------------------------------------------------------------------------------------------------------------------------------------------|------------------------------------|
| Communication system          | BLUETOOTH Specification version 4.2                                                                                                                                                                                                                                                            |                                    |
| Frequency band                | 2.4 GHz band                                                                                                                                                                                                                                                                                   |                                    |
| Modulation method             | FHSS (Frequency Hopping Spread Spectrum)                                                                                                                                                                                                                                                       |                                    |
| Compatible BLUETOOTH profiles | A2DP 1.2, AVRCP 1.3                                                                                                                                                                                                                                                                            |                                    |
| Supported Codecs              | Receiving: SBC, AAC<br>Transmitting: SBC, aptX, aptX HD                                                                                                                                                                                                                                        |                                    |
| Transmission range (A2DP)     | 20 Hz - 20 kHz (Sampling frequency 44.1 kHz)                                                                                                                                                                                                                                                   |                                    |
| Maximum communication range   | Line of sight approx. 15 m(*)<br>(*)The actual range will vary depending on factors such as obstacles between devices, magnetic fields around a microwave oven, static electricity, cordless phone, reception sensitivity, antenna's performance, operating system, software application, etc. |                                    |

| <b>HDMI</b> | <b>North American models</b>                                                                                                                                                                                                                                                                                                                                           | <b>Australian and Asian models</b> |
|-------------|------------------------------------------------------------------------------------------------------------------------------------------------------------------------------------------------------------------------------------------------------------------------------------------------------------------------------------------------------------------------|------------------------------------|
| Input       | 6                                                                                                                                                                                                                                                                                                                                                                      |                                    |
| Output      | 2 (MAIN, SUB/ZONE2)                                                                                                                                                                                                                                                                                                                                                    |                                    |
| Supported   | Deep Color, x.v.Color™, Extended Colorimetry (sYCC601, Adobe RGB, Adobe YCC601), 3D, Content Type, CEC(*), Lip Sync, Audio Return Channel, HDR (HDR10, BT.2020, HLG), HDR10+ (HDMI IN1-IN3), Dolby Vision<br>(*)The unit is designed to link with products that comply with the CEC standard, however, linked operation is not always guaranteed with all CEC devices. |                                    |





|                               |                                                                                                                                                                                                                                                                                                                                                                                                                                                       |
|-------------------------------|-------------------------------------------------------------------------------------------------------------------------------------------------------------------------------------------------------------------------------------------------------------------------------------------------------------------------------------------------------------------------------------------------------------------------------------------------------|
| Audio Format                  | <p>2 ch linear PCM:<br/>32 kHz, 44.1 kHz, 48 kHz, 88.2 kHz, 96 kHz, 176.4 kHz, 192 kHz, 16/20/24 bit</p> <p>Multi-channel linear PCM:<br/>Maximum 7.1 channels, 32 kHz, 44.1 kHz, 48 kHz, 88.2 kHz, 96 kHz, 176.4 kHz, 192 kHz, 16/20/24 bit</p> <p>Bitstream:<br/>Dolby Digital, Dolby Digital Plus, Dolby TrueHD, Dolby Atmos, DTS, DTS-ES, DTS 96/24, DTS-HD Master Audio, DTS-HD High Resolution Audio, DTS Express, DTS:X, DSD(2.8 MHz), PCM</p> |
| ARC compatible audio formats  | PCM, Dolby Digital, Dolby Digital Plus, DTS (DTS 96/24, DTS-ES, etc.), DTS-HD High Resolution Audio                                                                                                                                                                                                                                                                                                                                                   |
| eARC compatible audio formats | PCM, Dolby Digital, Dolby Digital Plus, DTS (DTS 96/24, DTS-ES, etc.), Dolby TrueHD, Dolby Atmos, DTS- HD Master Audio, DTS:X, Multichannel PCM, DTS-HD High Resolution Audio                                                                                                                                                                                                                                                                         |
| HDCP version                  | HDCP2.3                                                                                                                                                                                                                                                                                                                                                                                                                                               |
| Maximum Video Resolution      | 8K                                                                                                                                                                                                                                                                                                                                                                                                                                                    |



| Corresponding input resolutions | Frame rate     | Color space    | Color Depth    | HDMI IN 1 - 3 | HDMI IN 4 - 6 |
|---------------------------------|----------------|----------------|----------------|---------------|---------------|
| 4K<br>(3840x2160p)              | 24/25/30 Hz    | YCbCr4:2:2     | 12 bit         | ✓             | ✓             |
|                                 |                | YCbCr4:4:4/RGB | 8 bit          | ✓             | ✓             |
|                                 |                |                | 10/12 bit      | ✓             | ✓             |
| 4K SMPTE<br>(4096x2160p)        | 48/50/60 Hz    | YCbCr4:2:0     | 8 bit          | ✓             | ✓             |
|                                 |                |                | 10/12 bit      | ✓             | ✓             |
|                                 |                | YCbCr4:2:2     | 12 bit         | ✓             | ✓             |
|                                 |                |                | YCbCr4:4:4/RGB | 8 bit         | ✓             |
|                                 | 100/120 Hz     | YCbCr4:2:0     |                | 8/10/12 bit   | ✓             |
|                                 |                |                | YCbCr4:2:2     | 12 bit        | ✓(*)          |
|                                 | YCbCr4:4:4/RGB | 8/10 bit       |                | ✓(*)          |               |
|                                 |                |                |                |               |               |
| 5K<br>(5120x2160p)              | 24/25/30 Hz    | YCbCr4:2:2     | 12 bit         | ✓             |               |
|                                 |                | YCbCr4:4:4/RGB | 8 bit          | ✓             |               |
|                                 |                |                | 10/12 bit      | ✓             |               |
|                                 | 48/50/60 Hz    | YCbCr4:2:0     | 8/10/12 bit    | ✓             |               |
|                                 |                | YCbCr4:2:2     | 12 bit         | ✓(*)          |               |
| YCbCr4:4:4/RGB                  |                | 8/10/12 bit    | ✓(*)           |               |               |
| 8K<br>(7680x4320p)              | 24/25/30 Hz    | YCbCr4:2:0     | 8/10/12 bit    | ✓             |               |
|                                 |                | YCbCr4:2:2     | 12 bit         | ✓(*)          |               |
|                                 |                | YCbCr4:4:4/RGB | 8/10 bit       | ✓(*)          |               |
|                                 | 48/50/60 Hz    | YCbCr4:2:0     | 8/10 bit       | ✓(*)          |               |

(\*)Video compressed with DSC (Display Stream Compression) can be input and output. DSC is a video compression technique that enables the transmission of high-resolution video, which requires high bandwidth, via HDMI.

- Signals are output from the HDMI OUT jack of this unit to the TV with the same resolution as the input resolution. When a TV supporting 4K is used, HDMI video signals with 1080p can be output with 4K.

For linked functions to work properly, do not connect CEC-compliant devices exceeding the connectable number to the HDMI jack as shown below.

- Blu-ray Disc/DVD players: up to 3 units
- Blu-ray Disc/DVD recorders: up to 3 units
- Cable TV tuner, terrestrial digital tuner, and satellite broadcasting tuner: up to 4 units

Operation has been confirmed on the following devices: (As of April 2020)

Toshiba brand televisions; Sharp brand televisions; Onkyo and Integra brand RIHD-compatible players; Toshiba brand players and recorders; Sharp brand players and recorders (when used with a Sharp brand television)



| Network Section                                                             | North American models                                                                                                                                                                                                                                                                                                                                                                                                                                                                                                                                                                                                                                                                                                                                                                                                                                                                                                                                                                                                                                                                                                                                                                                                                                                                                                                                                                                                                                                                                                                                        | Australian and Asian models |
|-----------------------------------------------------------------------------|--------------------------------------------------------------------------------------------------------------------------------------------------------------------------------------------------------------------------------------------------------------------------------------------------------------------------------------------------------------------------------------------------------------------------------------------------------------------------------------------------------------------------------------------------------------------------------------------------------------------------------------------------------------------------------------------------------------------------------------------------------------------------------------------------------------------------------------------------------------------------------------------------------------------------------------------------------------------------------------------------------------------------------------------------------------------------------------------------------------------------------------------------------------------------------------------------------------------------------------------------------------------------------------------------------------------------------------------------------------------------------------------------------------------------------------------------------------------------------------------------------------------------------------------------------------|-----------------------------|
| Ethernet LAN                                                                | 1 (10BASE-T/100BASE-TX)                                                                                                                                                                                                                                                                                                                                                                                                                                                                                                                                                                                                                                                                                                                                                                                                                                                                                                                                                                                                                                                                                                                                                                                                                                                                                                                                                                                                                                                                                                                                      |                             |
| Wireless LAN                                                                | IEEE 802.11 a/b/g/n/ac standard (Wi-Fi® standard) 5 GHz/2.4 GHz band                                                                                                                                                                                                                                                                                                                                                                                                                                                                                                                                                                                                                                                                                                                                                                                                                                                                                                                                                                                                                                                                                                                                                                                                                                                                                                                                                                                                                                                                                         |                             |
| <p>■ Music Server ( → <a href="#">p91</a> )<br/>Supported Audio Formats</p> | <p><b>MP3 (.mp3)</b></p> <ul style="list-style-type: none"> <li>• MPEG-1/MPEG-2 Audio Layer-3/44.1 kHz, 48 kHz/Between 8 kbps and 320 kbps, and VBR</li> </ul> <p><b>WMA (.wma)</b></p> <ul style="list-style-type: none"> <li>• 44.1 kHz, 48 kHz/Between 5 kbps and 320 kbps, and VBR</li> <li>• WMA Pro/Voice/WMA Lossless formats are not supported.</li> </ul> <p><b>WAV (.wav)</b></p> <p>WAV files contain uncompressed PCM digital audio.</p> <ul style="list-style-type: none"> <li>• 44.1 kHz, 48 kHz, 88.2 kHz, 96 kHz, 176.4 kHz, 192 kHz/8 bit, 16 bit, 24 bit</li> </ul> <p><b>AIFF (.aiff/.aif)</b></p> <p>AIFF files contain uncompressed PCM digital audio.</p> <ul style="list-style-type: none"> <li>• 44.1 kHz, 48 kHz, 88.2 kHz, 96 kHz, 176.4 kHz, 192 kHz/8 bit, 16 bit, 24 bit</li> </ul> <p><b>AAC (.aac/.m4a/.mp4/.3gp/.3g2)</b></p> <ul style="list-style-type: none"> <li>• MPEG-2/MPEG-4 Audio/44.1 kHz, 48 kHz, 88.2 kHz, 96 kHz/Between 8 kbps and 320 kbps, and VBR</li> </ul> <p><b>FLAC (.flac)</b></p> <ul style="list-style-type: none"> <li>• 44.1 kHz, 48 kHz, 88.2 kHz, 96 kHz, 176.4 kHz, 192 kHz/8 bit, 16 bit, 24 bit</li> </ul> <p><b>LPCM (Linear PCM)</b></p> <ul style="list-style-type: none"> <li>• 44.1 kHz, 48 kHz/16 bit</li> </ul> <p><b>Apple Lossless (.m4a/.mp4)</b></p> <ul style="list-style-type: none"> <li>• 44.1 kHz, 48 kHz, 88.2 kHz, 96 kHz/16 bit, 24 bit</li> </ul> <p><b>DSD (.dsf/.dff)</b></p> <ul style="list-style-type: none"> <li>• DSF/DSDIFF/2.8 MHz, 5.6 MHz, 11.2 MHz</li> </ul> |                             |



| USB Section                                                                       | North American models                                                                                                                                                                                                                                                                                                                                                                                                                                                                                                                                                                                                                                                                                                                                                                                                                                                                                                                                                                                                                                                                                                                                                                                                                                                                                                                                                                                                                                                                                                                                                            | Australian and Asian models |
|-----------------------------------------------------------------------------------|----------------------------------------------------------------------------------------------------------------------------------------------------------------------------------------------------------------------------------------------------------------------------------------------------------------------------------------------------------------------------------------------------------------------------------------------------------------------------------------------------------------------------------------------------------------------------------------------------------------------------------------------------------------------------------------------------------------------------------------------------------------------------------------------------------------------------------------------------------------------------------------------------------------------------------------------------------------------------------------------------------------------------------------------------------------------------------------------------------------------------------------------------------------------------------------------------------------------------------------------------------------------------------------------------------------------------------------------------------------------------------------------------------------------------------------------------------------------------------------------------------------------------------------------------------------------------------|-----------------------------|
| USB                                                                               | 1 (Rear : Ver.2.0, 5V/1 A)                                                                                                                                                                                                                                                                                                                                                                                                                                                                                                                                                                                                                                                                                                                                                                                                                                                                                                                                                                                                                                                                                                                                                                                                                                                                                                                                                                                                                                                                                                                                                       |                             |
| <p>■ USB Storage Device ( → <a href="#">p88</a> )<br/>Supported Audio Formats</p> | <p><b>MP3 (.mp3)</b></p> <ul style="list-style-type: none"> <li>• MPEG-1/MPEG-2 Audio Layer-3/44.1 kHz, 48 kHz/Between 8 kbps and 320 kbps, and VBR</li> </ul> <p><b>WMA (.wma)</b></p> <ul style="list-style-type: none"> <li>• 44.1 kHz, 48 kHz/Between 5 kbps and 320 kbps, and VBR</li> <li>• WMA Pro/Voice/WMA Lossless formats are not supported.</li> </ul> <p><b>WAV (.wav)</b></p> <p>WAV files contain uncompressed PCM digital audio.</p> <ul style="list-style-type: none"> <li>• 44.1 kHz, 48 kHz, 88.2 kHz, 96 kHz, 176.4 kHz, 192 kHz/8 bit, 16 bit, 24 bit</li> </ul> <p><b>AIFF (.aiff/.aif)</b></p> <p>AIFF files contain uncompressed PCM digital audio.</p> <ul style="list-style-type: none"> <li>• 44.1 kHz, 48 kHz, 88.2 kHz, 96 kHz, 176.4 kHz, 192 kHz/8 bit, 16 bit, 24 bit</li> </ul> <p><b>AAC (.aac/.m4a/.mp4/.3gp/.3g2)</b></p> <ul style="list-style-type: none"> <li>• MPEG-2/MPEG-4 Audio/44.1 kHz, 48 kHz, 88.2 kHz, 96 kHz/Between 8 kbps and 320 kbps, and VBR</li> </ul> <p><b>FLAC (.flac)</b></p> <ul style="list-style-type: none"> <li>• 44.1 kHz, 48 kHz, 88.2 kHz, 96 kHz, 176.4 kHz, 192 kHz/8 bit, 16 bit, 24 bit</li> </ul> <p><b>LPCM (Linear PCM)</b></p> <ul style="list-style-type: none"> <li>• 44.1 kHz, 48 kHz/16 bit</li> </ul> <p><b>Apple Lossless (.m4a/.mp4)</b></p> <ul style="list-style-type: none"> <li>• 44.1 kHz, 48 kHz, 88.2 kHz, 96 kHz, 176.4 kHz, 192 kHz/16 bit, 24 bit</li> </ul> <p><b>DSD (.dsf/.dff)</b></p> <ul style="list-style-type: none"> <li>• DSF/DSDIFF/2.8 MHz, 5.6 MHz, 11.2 MHz</li> </ul> |                             |



| General                                                                                   | North American models                                                                                                                                                                                                                                          | Australian and Asian models |
|-------------------------------------------------------------------------------------------|----------------------------------------------------------------------------------------------------------------------------------------------------------------------------------------------------------------------------------------------------------------|-----------------------------|
| Power Supply                                                                              | AC 120 V, 60 Hz                                                                                                                                                                                                                                                | AC 220 - 240 V, 50/60 Hz    |
| Power Consumption                                                                         | 460 W                                                                                                                                                                                                                                                          | 450 W                       |
| Full Standby mode                                                                         | 0.10 W                                                                                                                                                                                                                                                         | 0.15 W                      |
| Network Standby (wired)                                                                   | 1.6 W                                                                                                                                                                                                                                                          | 1.7 W                       |
| Network Standby (wireless)                                                                | 1.7 W                                                                                                                                                                                                                                                          |                             |
| Bluetooth Wakeup                                                                          | 1.6 W                                                                                                                                                                                                                                                          | 1.7 W                       |
| HDMI CEC                                                                                  | 0.10 W                                                                                                                                                                                                                                                         | 0.15 W                      |
| Standby mode (ALL ON)                                                                     | 1.7 W                                                                                                                                                                                                                                                          | 1.8 W                       |
| Equipment with HiNA functionality Standby mode, Network disconnect and Network Standby ON | 2.7 W                                                                                                                                                                                                                                                          | 2.8 W                       |
|                                                                                           | This equipment complies with European Commission Regulation (EC) No 1275/2008 as equipment with HiNA functionality. If you do not to use the Network function, please set Network Standby setting to Off. You can reduce power consumption under standby mode. |                             |
| Dimensions (W × H × D)                                                                    | 435 mm × 174 mm × 376.5 mm<br>17-1/8" × 6-7/8" × 14-13/16"                                                                                                                                                                                                     |                             |
| Weight                                                                                    | 9.6 kg (21.2 lbs.)                                                                                                                                                                                                                                             | 9.8 kg (21.6 lbs.)          |

| Video Inputs | North American models | Australian and Asian models |
|--------------|-----------------------|-----------------------------|
| Composite    | Not equipped          |                             |
| Component    | Not equipped          |                             |

| Audio Inputs | North American models    | Australian and Asian models |
|--------------|--------------------------|-----------------------------|
| Analog       | 5 (Including 1×PHONO)    |                             |
| Digital      | 2 (COAXIAL×1, OPTICAL×1) |                             |



| Audio Outputs   | North American models                                                                                                              | Australian and Asian models |
|-----------------|------------------------------------------------------------------------------------------------------------------------------------|-----------------------------|
| Analog          | PRE/LINE OUT (ZONE 2)(*) × 1<br>PRE OUT (SUBWOOFER) × 2<br>*Can be changed to LINE OUT (ZONE B) and PRE OUT (FRONT).               |                             |
| Speaker Outputs | 9 (FRONT L/R, CENTER, SURROUND L/R, HEIGHT L/R or SURROUND BACK L/R, ZONE 2 L/R)<br>• North American models are banana plug ready. |                             |
| Phones          | 1 (ø 6.3 mm, 1/4")                                                                                                                 |                             |

| Others          | North American models          | Australian and Asian models |
|-----------------|--------------------------------|-----------------------------|
| Setup Mic       | 1 (Front)                      |                             |
| RS-232          | 1                              |                             |
| 12V TRIGGER OUT | 3 (A:100 mA, B:25 mA, C:25 mA) |                             |
| IR              | 2 (IN), 1 (OUT)                |                             |

Specifications and features are subject to change without notice.

 → [License and Trademark](#)



# Integra