

# Integra

## Instruction Manual

# DTM-7

Network Stereo Receiver



# Table of Contents

<b>Before Start</b> .....	<b>2</b>
What's in the box .....	3
<b>Part Names</b> .....	<b>4</b>
Part Names .....	4
<b>Install</b> .....	<b>9</b>
Step1: Speaker Layout .....	9
Step2: Connect the Speakers .....	10
Step3: Connect the TV & AV Components .....	11
<b>Initial Setup</b> .....	<b>16</b>
Initial Setup with Auto Start-up Wizard .....	16
<b>Playback</b> .....	<b>18</b>
AV Component Playback .....	18
BLUETOOTH® Playback .....	19
Internet Radio .....	20
Spotify .....	22
AirPlay® .....	23
USB Storage Device .....	24
Listening To the AM/FM Radio .....	25
Music Server .....	27
Multi-zone .....	29
Supplementary information for player functions ....	30
<b>Advanced Setup</b> .....	<b>31</b>
Setup Menu .....	31
AUDIO Menu .....	44
Web Setup .....	46
Firmware Update .....	47
<b>Supplementary Information</b> .....	<b>50</b>
Supplementary Information .....	50
<b>Others</b> .....	<b>51</b>
Troubleshooting .....	51
General Specifications .....	56
Reference Information .....	58



## What's in the box

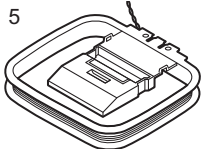
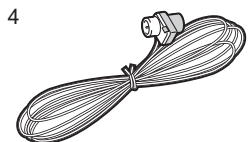
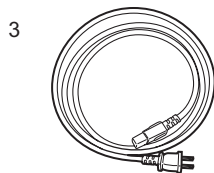
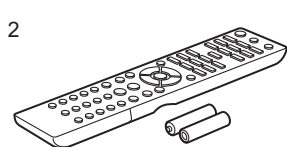
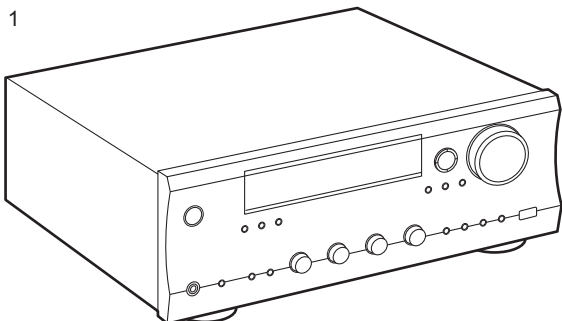

1. Main unit (1)
2. Remote controller (RC-906S) (1), batteries (AAA/R03) (2)
3. Power cord (1)
4. FM indoor antenna (1)
5. AM indoor antenna (1)

- Quick Start Guide (1)

\* This document is an online instruction manual. It is not included as an accessory.

- Connect speakers with 4  $\Omega$  to 16  $\Omega$  impedance. Note that when connecting to both SPEAKERS A and B terminals, connect speakers with 8  $\Omega$  to 16  $\Omega$  impedance to both A and B.
- The power cord must be connected only after all other cable connections are completed.
- We will not accept responsibility for damage arising from the connection of equipment manufactured by other companies.
- Functionality may be introduced by firmware updates and service providers may cease services, meaning that some network services and content may become unavailable in the future. Furthermore, available services may vary depending on your area of residence.
- Details on the firmware update will be posted on our website, etc.
- Specifications and appearance are subject to change without prior notice.

## Part Names

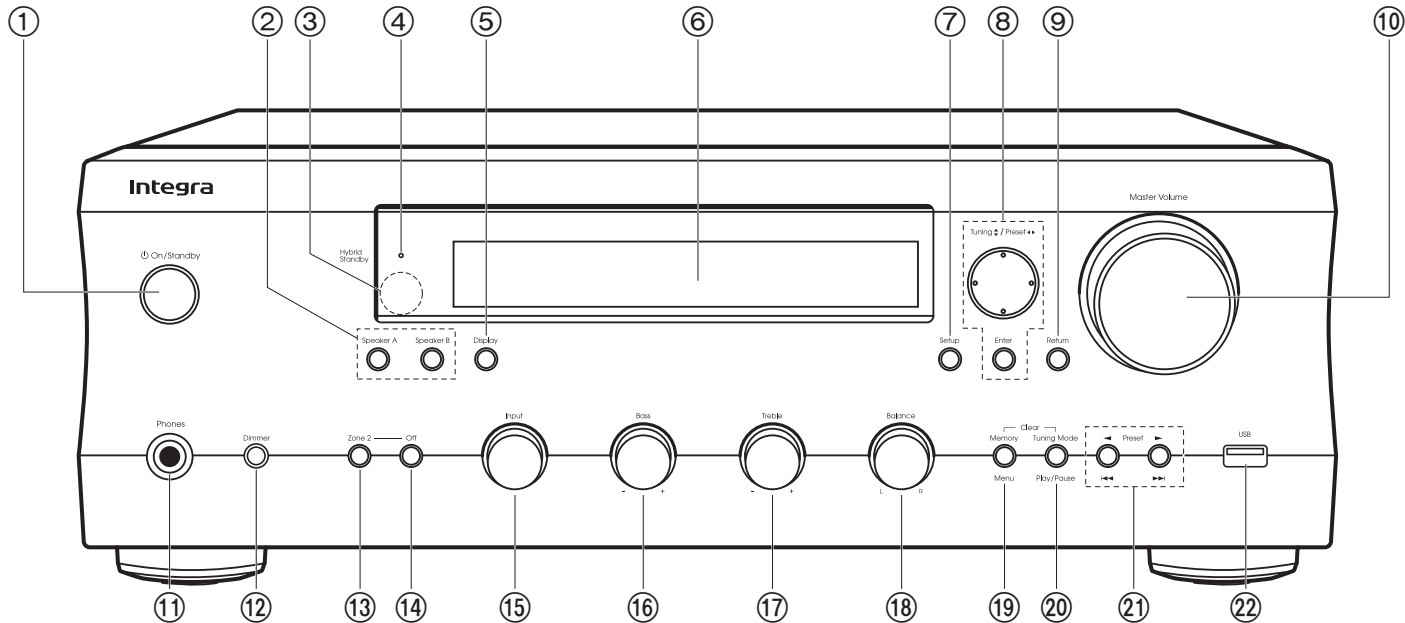

### Front Panel

1. On/Standby button
2. Speaker A/Speaker B button: Used to switch between outputting and turning off output from speakers connected to the SPEAKERS A or B terminal.
3. Remote control sensor: Receives signals from the remote controller.
  - The signal range of the remote controller is within about 16'5 m, at an angle of 20° on the perpendicular axis and 30° to either side.
4. Hybrid Standby indicator: Lights if the unit enters standby mode when the features are enabled that continue to work when this unit is in standby, such as HDMI Standby Through and Network Standby.
5. Display button: Switches the information on the display. You can display information such as the input source, volume, and input format when pressed repeatedly during play.
6. Display (P5)
7. Setup button: You can show advanced setting items on the TV and display to provide you with an even better experience (P31).
8. Cursors (▲ / ▼ / ◀ / ▶), Enter button: Select the item with the cursors and press Enter to confirm. Use them to tune to stations when using TUNER (P25).
9. Return button: Returns the display to the previous state during setting.
10. Master Volume
11. Phones jack: Connect stereo headphones with a standard plug (Ø1/4"/6.3 mm diameter).
12. Dimmer button: You can adjust the brightness of the display in three steps. It cannot be turned off completely.
13. Zone 2 button: Controls the multi-zone function (P29).
14. Off button: Switches the multi-zone function off (P29).
15. Input dial: Switches the input to be played.
16. Bass dial: Adjusts the bass.
17. Treble dial: Adjusts the treble.



- 18. Balance dial: Adjusts the balance of the sounds output from the left and right speakers.
- 19. Memory button: Used to register AM/FM radio stations (P26).  
Menu button: Used to display the menu.
- 20. Tuning Mode button: Switches tuning to an AM/FM station between automatic tuning and manual tuning (P25).  
Play/Pause button: Used for play operations when playing Music Server or USB.
- 21. Preset ◀▶ buttons: Used to select AM/FM radio stations.  
Skip (◀◀/▶▶) buttons: Used for play operations when playing Music Server or USB.
- 22. USB jack: A USB storage device is connected so that music files stored in it can be played. You can also supply power (5 V/1 A) to USB devices with a USB cable.

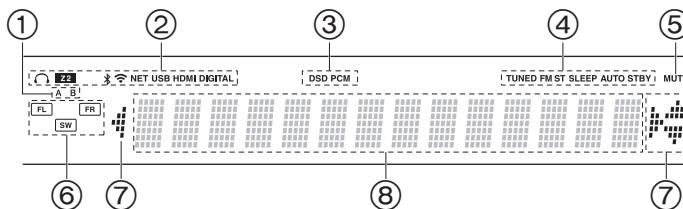

### Display

1. The currently selected speaker system lights.
2. Lights in the following conditions.
  - 🎧: When headphones are connected
  - Z2: ZONE 2 is on.
  - 📶: When connected via BLUETOOTH
  - 📶: When connected by Wi-Fi
  - NET: When "NET" is selected with the input selector and the unit is connected to the network. It will flash if the connection to the network is not correct.
  - USB: When "NET" is selected with the input selector and the unit is connected by USB and the USB device is selected. Flashes if the USB is not properly connected.
  - HDMI: HDMI signals are input and the HDMI input selector is selected.
  - DIGITAL: Digital signals are input and the digital input selector is selected.
3. Lights according to the type of input digital audio signals.
4. Lights in the following conditions.
  - TUNED: Receiving AM/FM radio
  - FM ST: Receiving FM stereo.
  - SLEEP: Sleep timer has been set (P39).
  - AUTO STBY: Auto Standby has been set (P39).
5. Flashes when muting is on.
6. Speaker/Channel display: Displays the output channel of the speakers.
7. This may light when performing operations with the "NET" input selector.
8. Displays various information of the input signals.

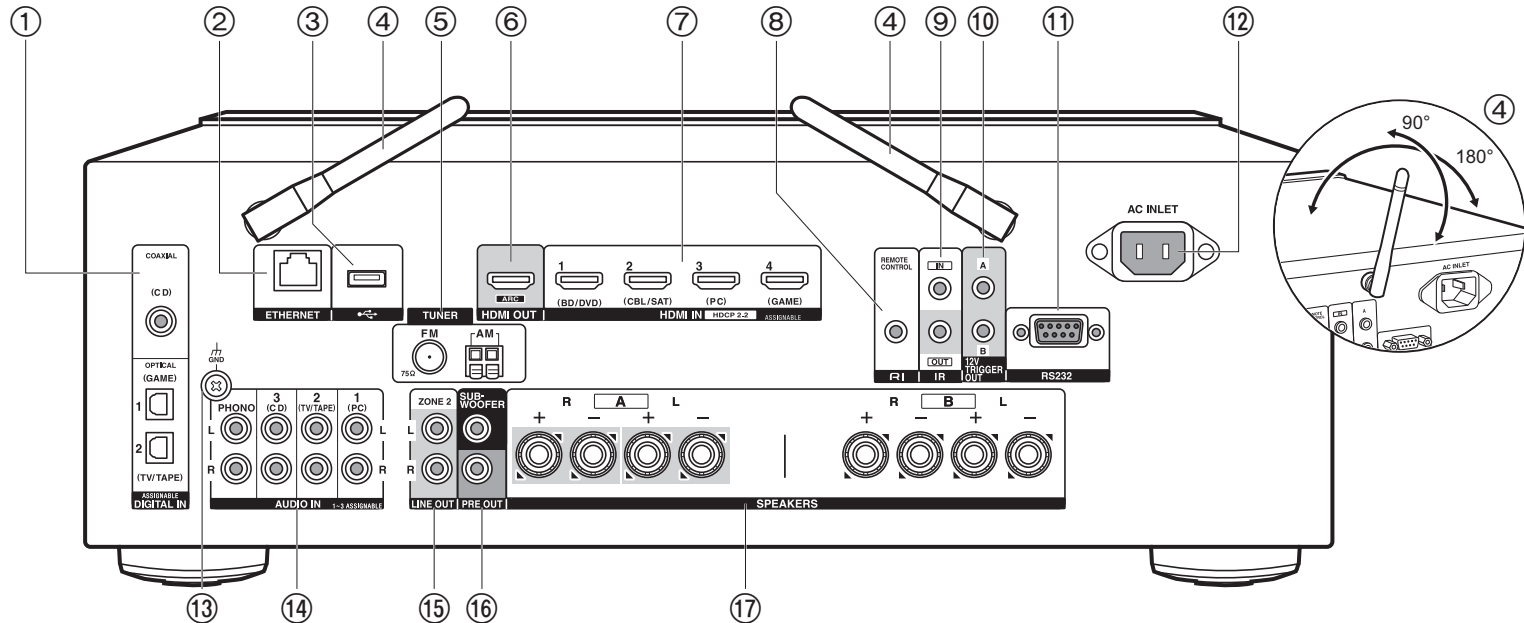

**Rear Panel**

1. DIGITAL IN OPTICAL/COAXIAL jacks: Input TV or AV component digital audio signals with a digital optical cable or digital coaxial cable.
2. ETHERNET jack: Connect to the network with an Ethernet cable.
3. USB jack: A USB storage device is connected so that music files stored in it can be played. You can also supply power (5 V/500 mA) to USB devices with a USB cable.
4. Wireless antenna: Raise for Wi-Fi connection or when using a BLUETOOTH wireless technology enabled device. Adjust their angles according to the connection status.
5. TUNER AM/FM 75Ω terminals: The supplied antennas are connected.
6. HDMI OUT jack: Connect a HDMI cable to transfer video signals and audio signals to a TV.
7. HDMI IN jacks: Input video signals and audio signals with a HDMI cable connected to an AV component.

8. **RI** REMOTE CONTROL jack: An Onkyo product with RI jack can be connected and synchronized with this unit (P13).
9. IR IN/OUT terminals: Connected to the multi-room remote control kit. (\*)
10. 12V TRIGGER OUT A/B jacks: Allows you to connect a device with 12V trigger input jack to enable link operation between the device and the unit (P40, 41). (\*)
11. RS232 port: For connection to the home control system. (\*)  
 (\*)Special devices or cable connections are necessary to use the control functions 9 to 11. Contact the specialized stores for more information.
- 12.AC INLET: Connect the supplied power cord.
- 13.GND jack: The ground wire of the turntable is connected.
- 14.AUDIO IN jacks: Input AV component audio signals with an analog audio cable.
- 15.ZONE 2 LINE OUT jacks: Output audio signals with an analog audio cable to a pre-main amplifier in a separate room (ZONE 2).
- 16.SUBWOOFER PRE OUT jacks: Connect a powered subwoofer with a subwoofer cable.

Up to two powered subwoofers can be connected. The same signal is output from each of the SUBWOOFER PRE OUT jacks.

17. SPEAKERS jacks: Connect speakers with speaker cables. (Compatible with banana plugs) You can connect a set of left and right speakers to each of the A/B terminals.

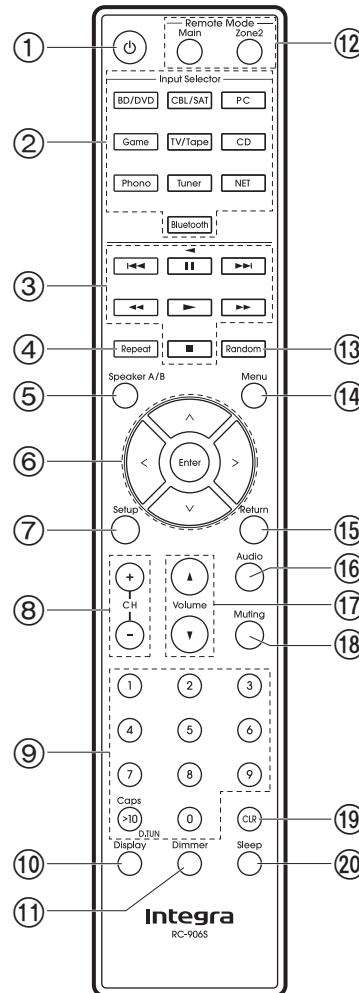

### Remote Controller

1. On/Standby button
2. Input Selector buttons: Switches the input to be played.
3. Play buttons: Used to control play of a Music Server or device connected via USB, or of RI connected devices.
  - The ◀▶, ▶▶, and ▶▶▶ buttons can only be used when playing RI connected devices.
4. Repeat button: Used for repeat play operations when playing Music Server or USB. Each time you press the button, the mode switches from 1 (1-track repeat) to (folder repeat).
5. Speaker A/B button: Select the terminals to output audio from between SPEAKERS A/B.
6. Cursors (▲ / ▼ / ◀ / ▶), Enter button: Select the item with the cursors and press Enter to confirm. When the folder or file lists are not shown on one screen on the TV, press ◀ / ▶ to change the screen.
7. Setup button: You can show advanced setting items on the TV and display to provide you with an even better experience (P31).
8. CH (+/-) buttons: Used to select AM/FM radio stations.
9. Numbered buttons
10. Display button: Switches the information on the display. You can display information such as the input source, volume, and input format when pressed repeatedly during play.
11. Dimmer button: You can adjust the brightness of the display in three steps. It cannot be turned off completely.
12. Remote Mode Main/Zone 2 buttons: Controls the multi-zone function (P29).
13. Random button: Used for random play operations when playing Music Server or USB. (Random) turns on or off each time you press the button.
14. Menu button: Used to display the menu.
15. Return button: Returns the display to the previous state during setting.
16. Audio button: Settings such as "Tone" and "Level" can be made quickly during play on the TV screen (P44).
17. Volume buttons
18. Muting button: Temporarily mutes audio. Press again to cancel muting.
19. CLR button: Deletes all characters you have entered when entering text on the TV screen.
20. Sleep button: Set the sleep timer (P39).



**Tips**

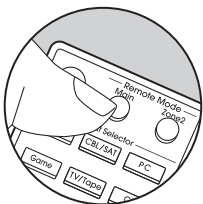

**When the remote controller isn't working:** The remote controller may have switched to the mode for controlling ZONE 2. Press Remote Mode Main to switch to the mode to control the main room.



## Step1: Speaker Layout

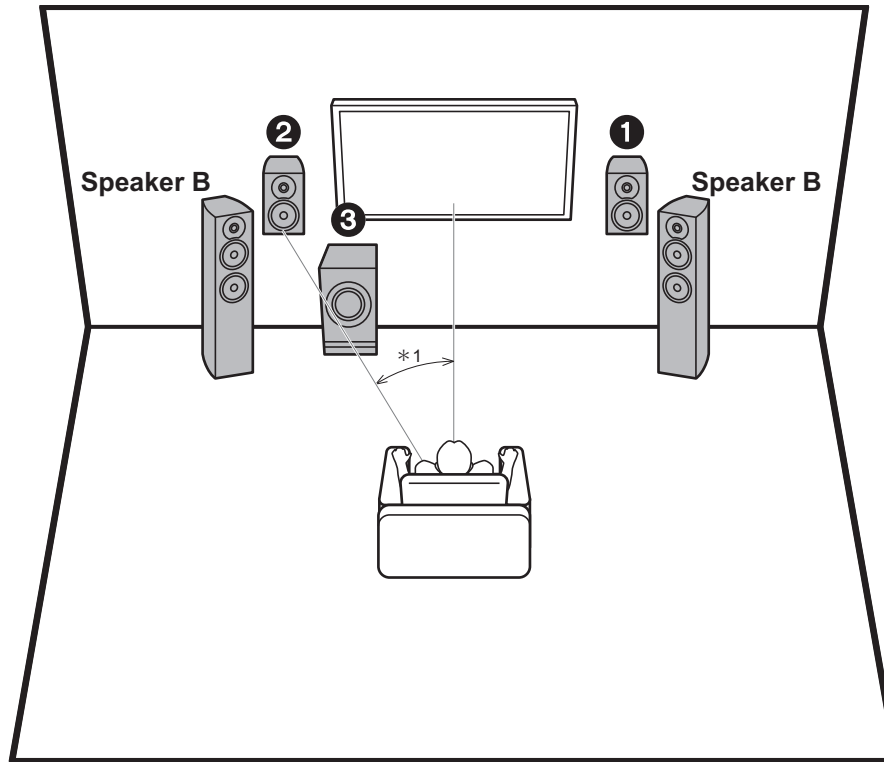

\*1: 22° to 30°

Front speakers output front stereo sound. The powered subwoofer reproduces bass sounds and enriches the sound field. The optimal positioning for front speakers is ear height. Placing the powered subwoofer between the front of the listening position and a front speaker gives you a natural sound even when playing music. You can connect one more set of front speakers to this unit to use as a Speaker B System. In this state, the front speakers **1,2** become the Speaker A System and you can switch the same audio to output from A, B, or A+B. Press Speaker A/B on the remote control to switch. The selection changes in the order SPEAKER A, SPEAKER B, SPEAKER A+B with each press.

- When connecting to both SPEAKERS A and B terminals, connect speakers with 8 Ω to 16 Ω impedance to both A and B.

- 1,2 Front Speakers
- 3 Powered Subwoofer

## Step2: Connect the Speakers

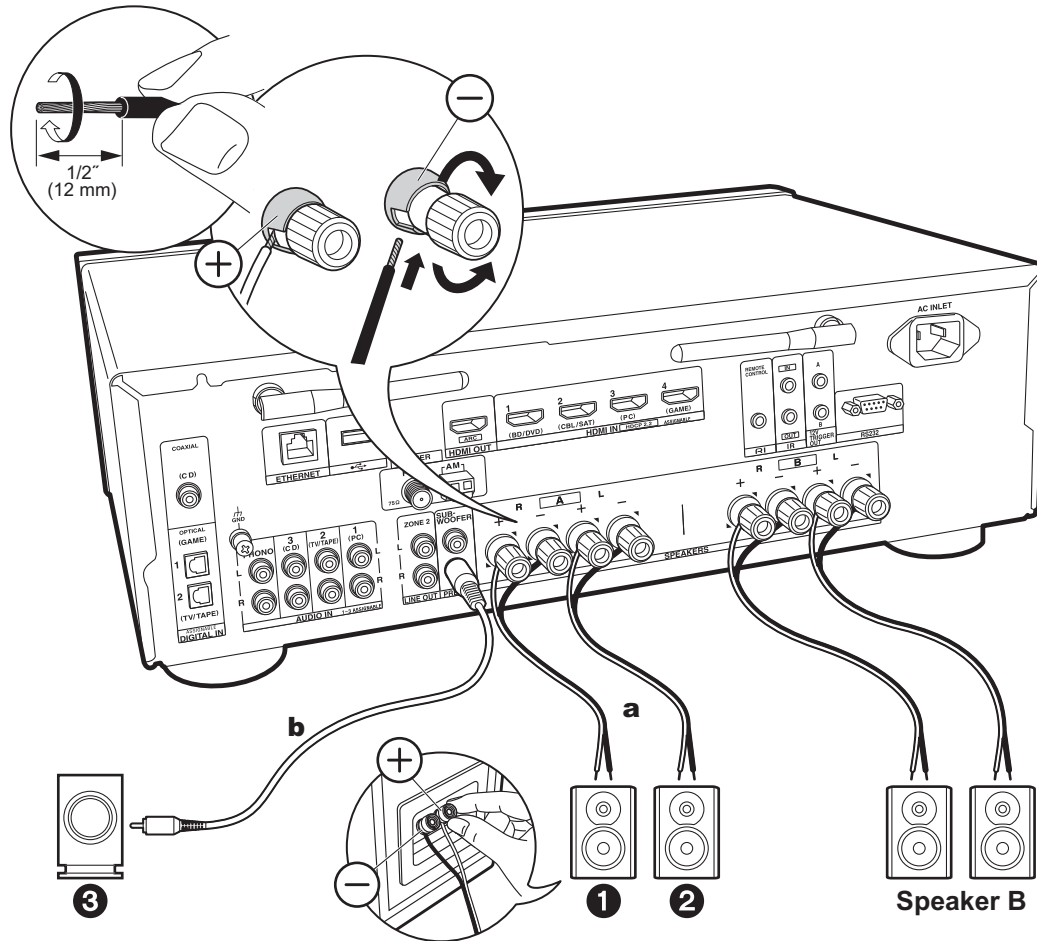

**a** Speaker cable, **b** Subwoofer cable

Up to two powered subwoofers can be connected. The same signal is output from each of the SUBWOOFER PRE OUT jacks. When connecting another set of front speakers to use as the Speakers B System, connect them to the SPEAKERS B terminals. Connect using the same method described for SPEAKERS A. Note that when connecting to both SPEAKERS A and B terminals, connect speakers with  $8\ \Omega$  to  $16\ \Omega$  impedance to both A and B.



### Setup

- If a powered subwoofer is not connected, then after Initial Setup is complete, settings are required in the Setup menu. Press Setup on the remote controller, select "2. Speaker" - "Configuration" and set "Subwoofer" to "No".
- If any of the connected speakers have an impedance of  $4\ \Omega$  or more to less than  $6\ \Omega$ , or when a Speaker B system is to be used, after completing Initial Setup, you need to make some settings in the Setup menu. Press Setup on the remote controller, select "2. Speaker" - "Configuration" and set "Speaker Impedance" to "4ohms".

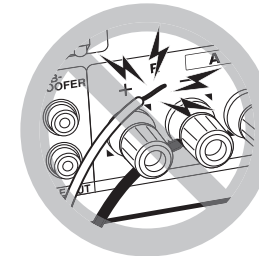

Connect the speaker cable so the wires do not protrude from the speaker jacks. If the exposed wires of the speakers touch the rear panel or the + and - wires touch each other, the protection circuit will be activated.

## Step3: Connect the TV & AV Components

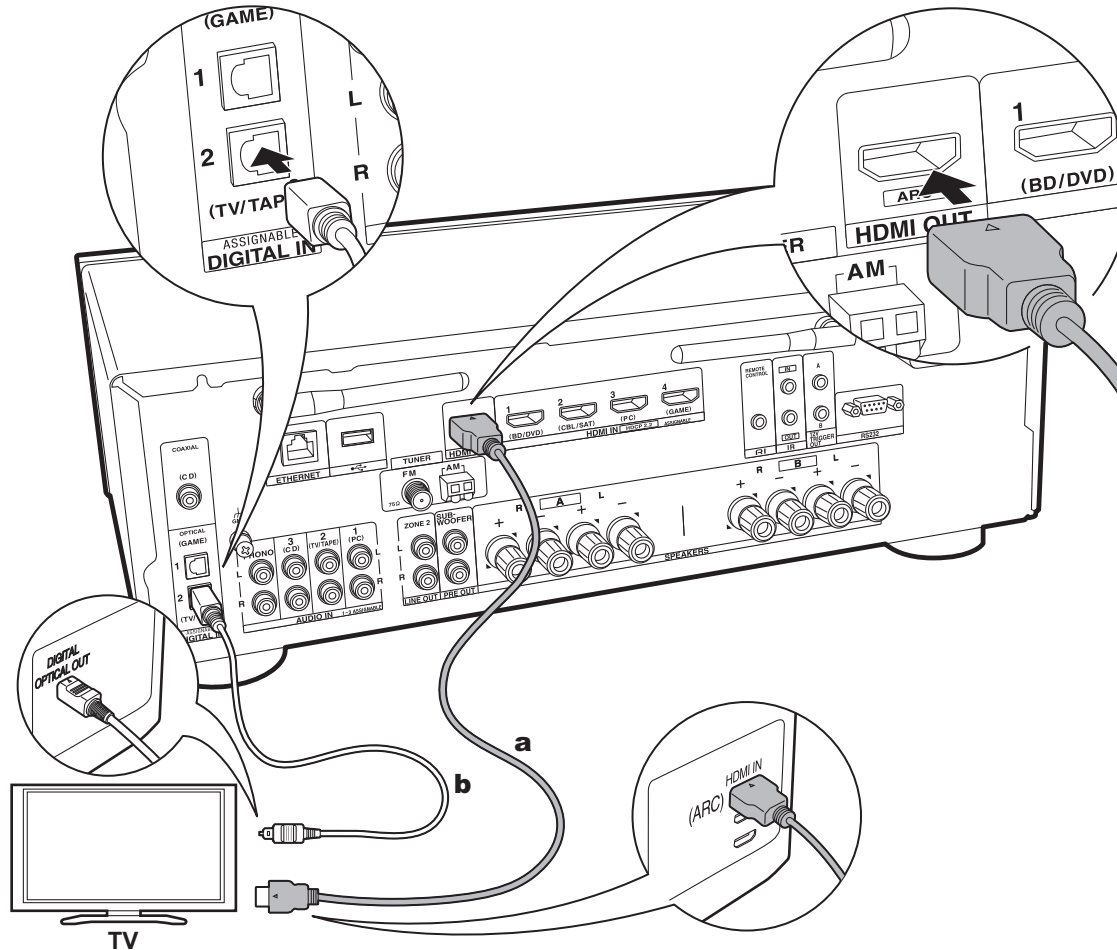

**a** HDMI cable, **b** Digital optical cable

### 1. Connect the TV

#### To ARC TV

For a TV that supports the ARC (Audio Return Channel) feature (\*), use an HDMI cable and connect according to illustration "a". Choose an HDMI IN jack on the TV that supports ARC when connecting.

- Only PCM audio input is supported from a TV to this unit.



#### Setup

- Settings are required to use the ARC function. For "4. Audio Return Channel" (P17) in Initial Setup, select "Yes".
- Refer to the instruction manual for the TV for TV connections and instructions regarding settings for CEC features and audio output.

#### To Non-ARC TV

For a TV that does not support the ARC (Audio Return Channel) feature (\*), connect both the HDMI cable in illustration "a" and the digital optical cable in "b".

- Connection with a digital optical cable is not necessary if you will watch TV through a device such as a cable set-top box (that is, not use a tuner built into the TV) that you have connected to the input jack on this unit.

(\* ) ARC feature: This feature transfers TV audio signals via HDMI cable so that you can play the audio from the TV through this unit. Connection to an ARC compatible TV is complete with one HDMI cable. Refer to the instruction manual for your TV to see if it supports ARC.

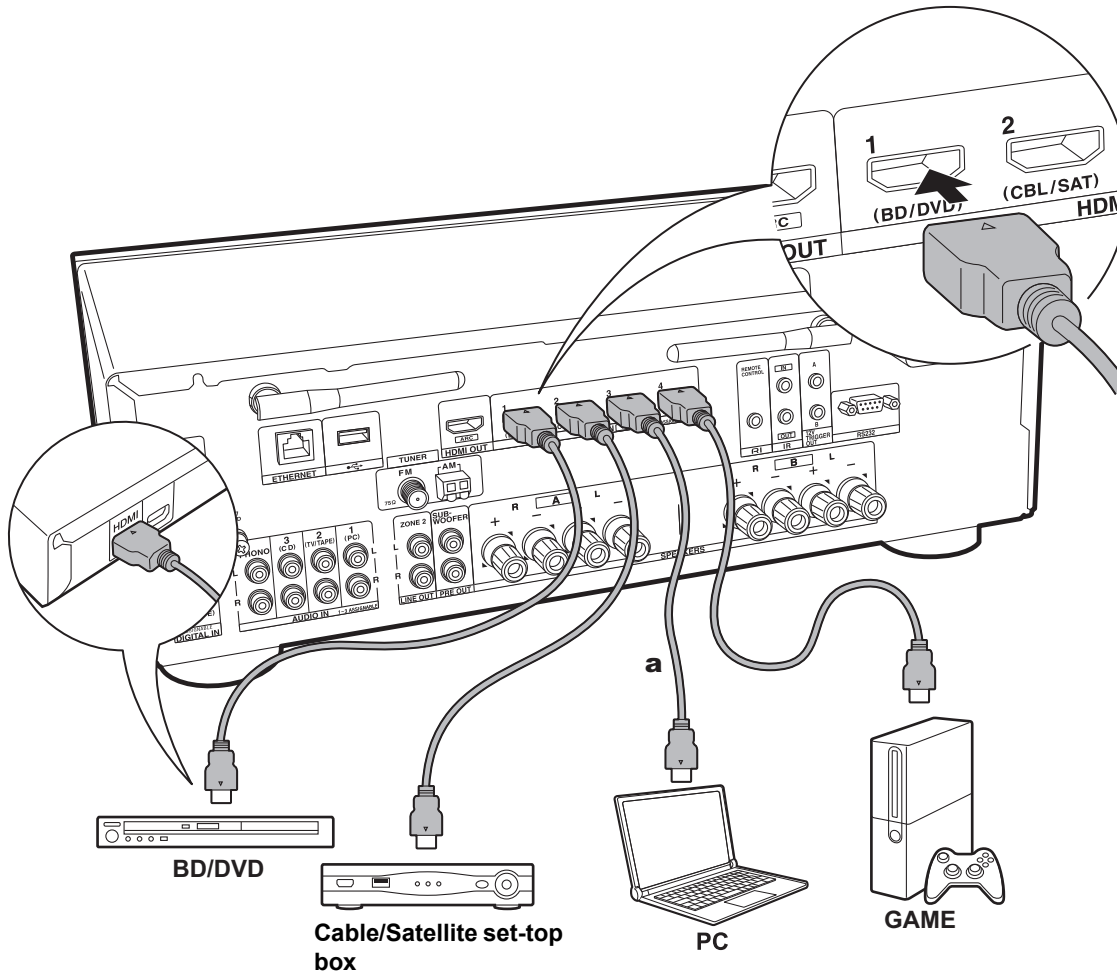

**a** HDMI cable

## 2. Connect the HDMI AV Component

This is an example of connection with an AV component that has an HDMI jack. With connection to an AV component that conforms with the CEC (Consumer Electronics Control) standard, you can use features such as the HDMI CEC feature (\*) that links with the input selector, and the HDMI Standby Through feature which allows you to play video and audio from AV components on the TV even when this unit is in standby mode.

- To play 4K or 1080p video, use the high speed HDMI cable.



### Setup

- When "Yes" is selected for "4. Audio Return Channel" in Initial Setup (P17), the HDMI CEC function and HDMI Standby Through function are automatically enabled. If "No, Skip" is selected, settings are required in the Setup menu after Initial Setup is complete. Press Setup on the remote controller and make the settings in "5. Hardware" - "HDMI".
- The audio from connected AV components can only be played when the audio is PCM or DSD. To play PCM audio, set the audio output on the AV component to output PCM.

(\*) HDMI CEC feature: You can control features such as linking input switching with the input selector and players conforming to the CEC standard, switching audio to output it from the TV or from this unit, and adjusting the volume using the remote controller of a CEC-compliant TV, and automatically switching this unit to standby when the TV is turned off.

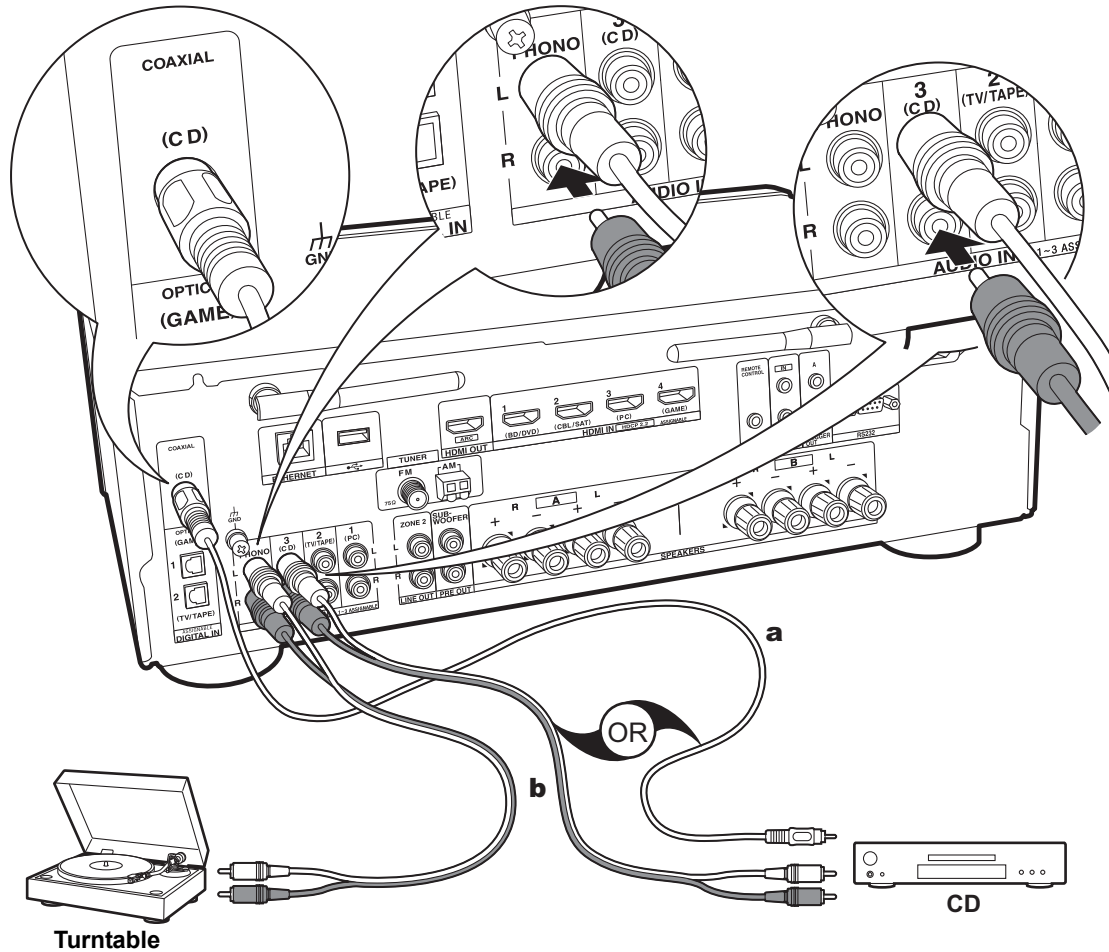

**a** Digital coaxial cable, **b** Analog audio cable

### 3. Connect the Audio Component

Example of a connection with an audio component. Connect a CD player using a digital coaxial cable or analog audio cable. You can connect a turntable that has an MM-type cartridge to the PHONO jack.

- If the turntable has a built-in audio equalizer, connect it to an AUDIO IN jack other than the PHONO jack. Also, if the turntable uses an MC type cartridge, install an audio equalizer compatible with the MC type cartridge between the unit and the turntable, then connect to any AUDIO IN jack other than the PHONO jack.

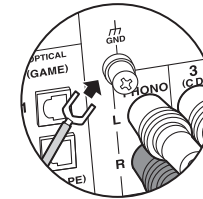

If the turntable has a ground wire, connect it to the GND terminal.

- By connecting an Onkyo component with RI jack to the unit by using an RI cable and an analog audio cable, you can link the unit's power and input selection and enable operation with this unit's remote controller. For details, refer to the instruction manual of the component with the RI jack.
  - Part of the function may not operate even if it is connected via RI depending on the equipment.
  - The RI dock function does not work if ZONE 2 is on.
  - When connecting an RI dock, you must rename the input selectors on the unit to make the system link work. Select the GAME input selector to display "GAME" on the main unit display. Then press and hold Return on the main unit for 3 seconds to switch the display to "DOCK".

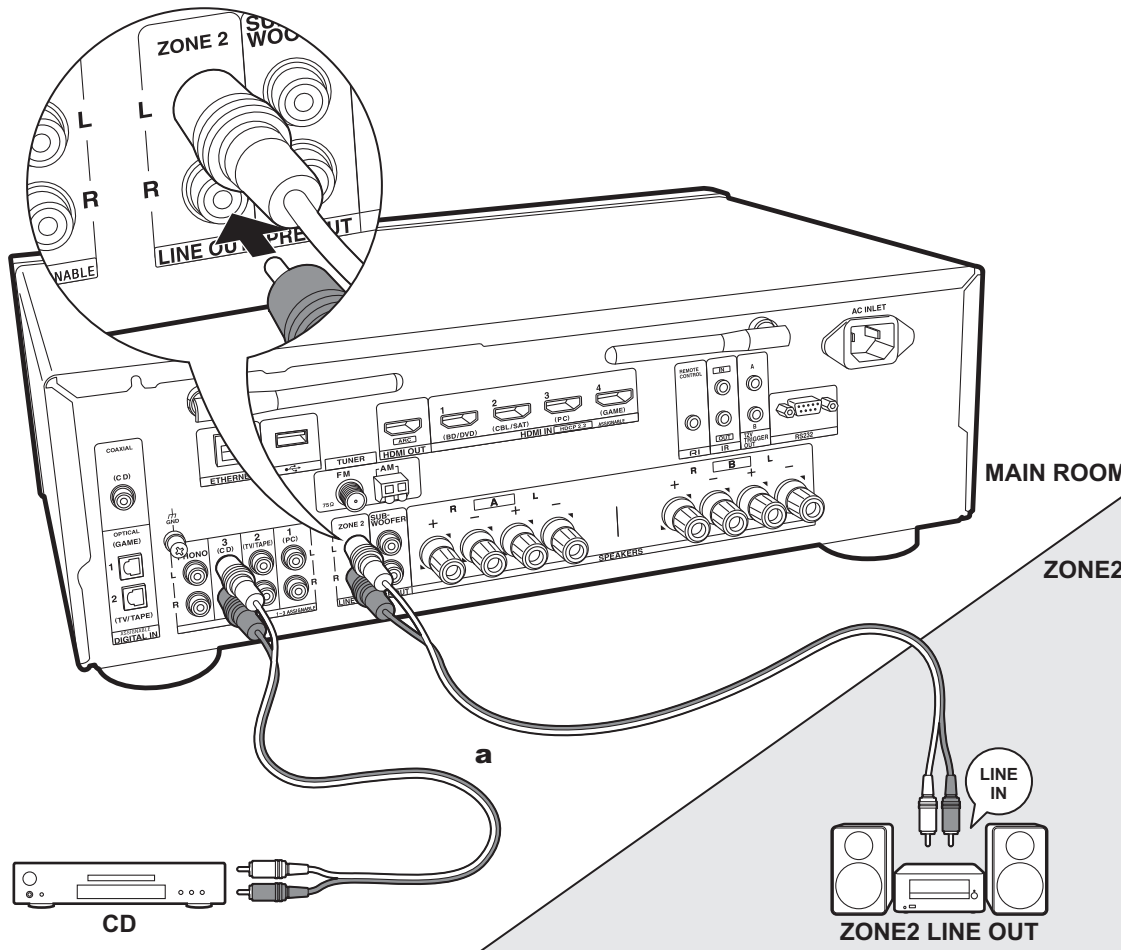

**a** Analog audio cable

#### 4. Multi-zone Connection

You can enjoy audio in the separate room by, for example, playing a Blu-ray Disc player in the main room (where this unit is located) and listening to internet radio in the separate room (ZONE 2).

- DSD audio signals are not output to ZONE 2 with the "NET" input selector.

#### Connections with an AV component

When outputting the audio of an external AV component to ZONE 2, connect using an analog audio cable.

#### ZONE 2 LINE OUT

Connect the ZONE 2 LINE OUT jacks of the unit and the LINE IN jacks of the pre-main amplifier in a separate room with an analog audio cable.



#### Setup

- To use this feature, settings are required in Initial Setup, "3. Multi Zone Setup" (P17).

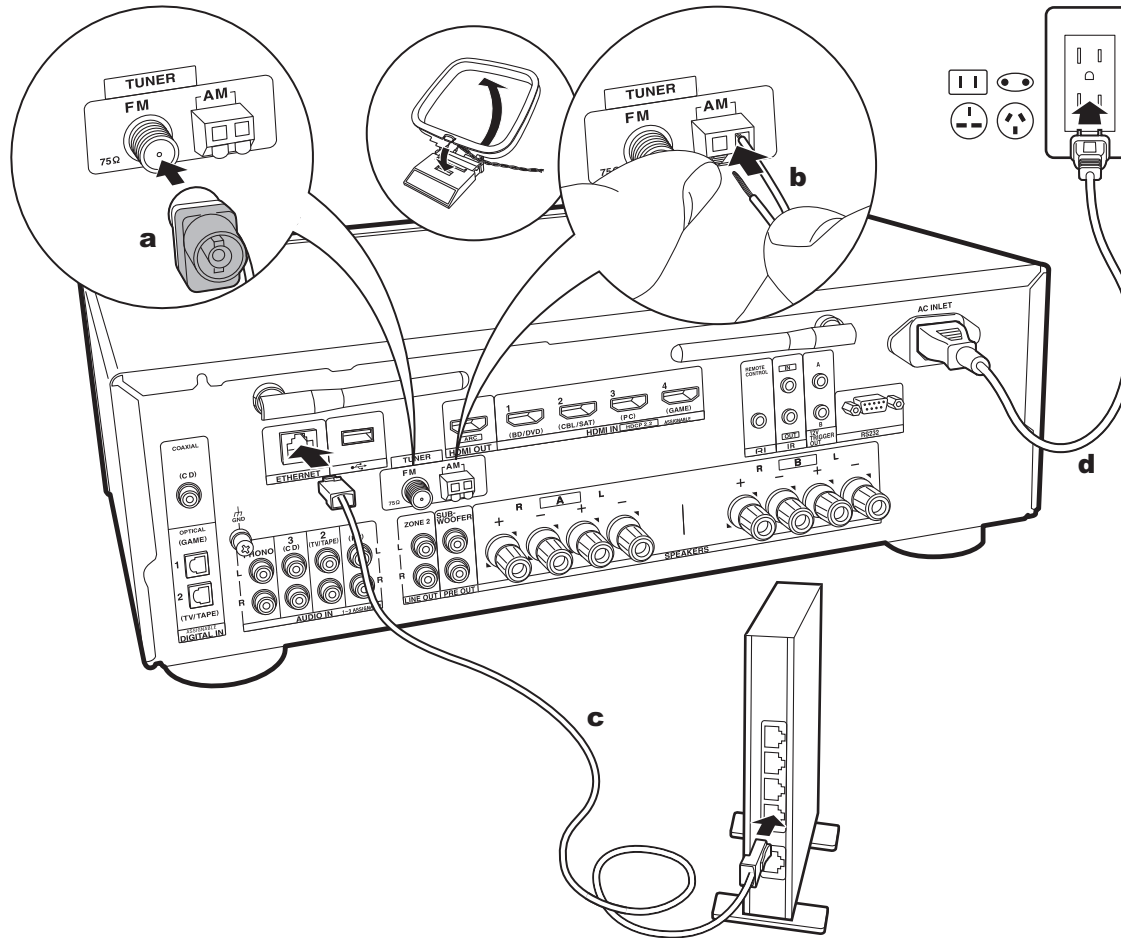

**a** FM indoor antenna, **b** AM indoor antenna, **c** Ethernet cable, **d** Power cord

## 5. Connect Other Cables

### Antenna Hookup

Move the antenna around while playing the radio to find the position with the best reception. Use a thumb tack or similar to attach the FM indoor antenna to a wall.

### Network Hookup

Connect this unit to the network using wired LAN or Wi-Fi (wireless LAN). You can enjoy Network Functions such as internet radio by connecting to the network. If you connect by wired LAN, connect to the router with an Ethernet cable to the ETHERNET port as shown in the illustration. To connect by Wi-Fi, after selecting "Wireless" in "2. Network Connection" (P16) in Initial Setup, select the desired setting method and follow the onscreen instructions to configure the connection.

### Power Cord Hookup

This model includes a removable power cord. The power cord must be connected only after all other connections are completed. Make sure you first connect the power cord to AC INLET of the unit and then connect to the outlet. Always disconnect the outlet side first when disconnecting the power cord.

## Initial Setup with Auto Start-up Wizard

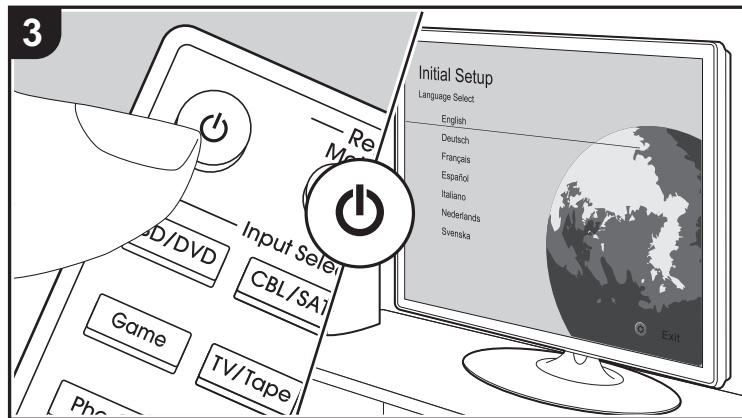
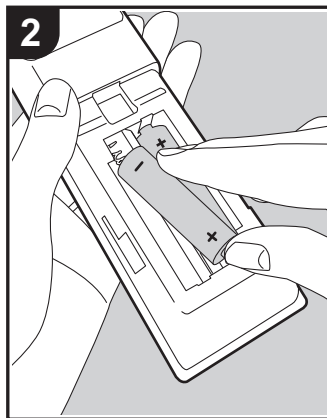
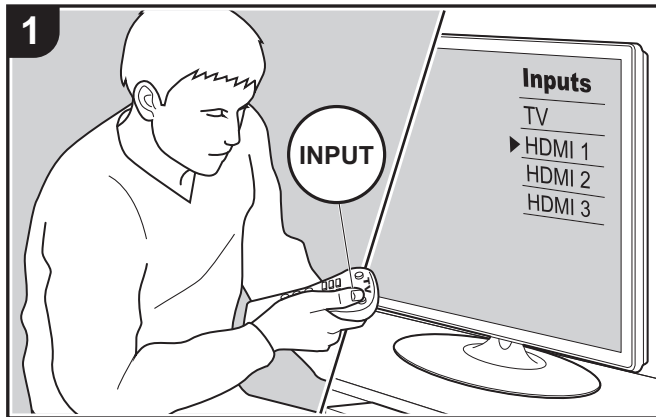

### Initial Setup starts automatically

When you turn the unit on for the first time after purchasing it, Initial Setup is automatically shown on the TV to enable you to make settings required for startup using simple operations following onscreen guidance.

1. Switch the input on the TV to that assigned to the unit.
2. Put batteries into the remote controller of this unit.
3. Press on the remote controller to turn the unit on.
4. Select the item with the cursors of the remote controller and press Enter (a) to confirm your selection. To return to the previous screen, press Return (b).

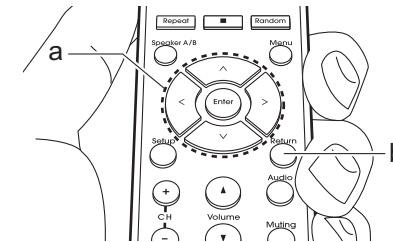

- If you terminate the procedure on the way or want to change a setting made during Initial Setup, press Setup on the remote controller, and select "7. Miscellaneous" - "Initial Setup" and press Enter. To select the language displayed again, change "OSD Language" (P31).

### ■ 1. Source Connection

Check that each input source is connected correctly. Follow the guidance, select the input you want to confirm, start play of the selected player, and confirm that the images appear on the TV and that sound is played.

### ■ 2. Network Connection

Set up Wi-Fi connection with an access point such as a wireless LAN router. There are the following two methods of





connecting by Wi-Fi:

**"Scan Networks"**: Search for an access point from this unit. Find out the SSID of the access point beforehand.

**"Use iOS Device (iOS7 or later)"**: Connect by sharing the iOS device's Wi-Fi settings with this unit.

If you select "Scan Networks", there are a further two choices of connection method. Check the following.

**"Enter Password"**: Enter the password (or key) of the access point to connect.

**"Push Button"**: If the access point has an automatic connection button, you can connect without entering a password.

- If the SSID of the access point is not displayed, then in the screen listing the SSIDs, select "Other..." with the > cursor on the remote controller and press Enter, then follow the onscreen instructions.

### Keyboard input

To switch between upper and lower case, select "A/a" on the screen and press Enter. To select whether to mask the password with "\*" or display it in plain text, press Menu on the remote control. Pressing CLR will delete all the input characters.

- A confirmation screen asking you to agree to the privacy policy is displayed during network setting. Select "Accept" and press Enter to indicate agreement.

### ■ 3. Multi Zone Setup

Make these settings to enjoy audio in a room other than the main room (ZONE 2).

### ■ 4. Audio Return Channel

If you have connected a TV that supports ARC, select "Yes". This unit's ARC setting turns on and you can listen to the TV's audio through this unit.

## AV Component Playback

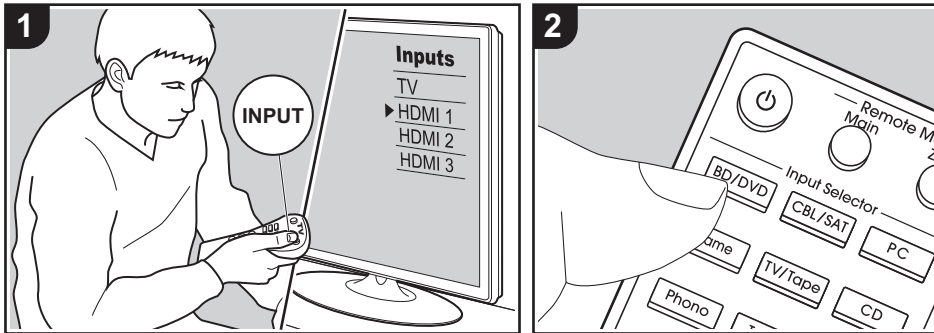

### Basic operations

You can play the audio from AV components such as Blu-ray Disc players through this unit.

Perform the following procedure when the unit is on.

1. Switch the input on the TV to that assigned to the unit.
2. Press the input selector (a) on the remote controller with the same name as the jack to which you connected the player to switch the input.

For example, press the BD/DVD button to play the player connected to the BD/DVD jack. Press TV/Tape to listen the TV's sound.

- When the CEC link function works, the input switches automatically when you have connected a CEC compliant TV and player to this unit using HDMI connection.

3. Start play on the AV component.

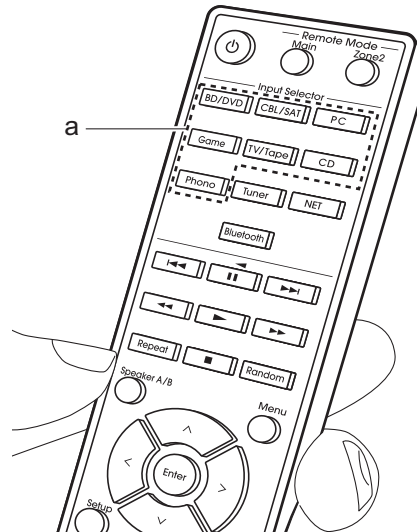



# BLUETOOTH® Playback

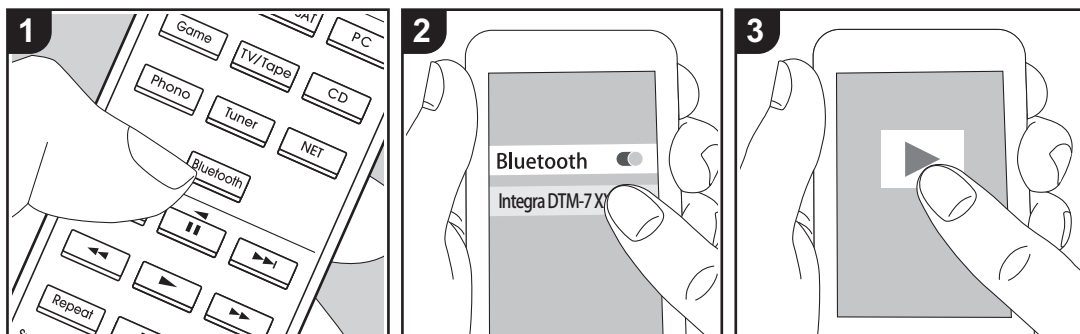

You can wirelessly play music on a smartphone or other BLUETOOTH wireless technology enabled device. Perform the following procedure when the unit is on.

## Pairing

1. When you press the Bluetooth button, "Now Pairing..." is displayed on this unit's display, and the pairing mode is enabled.

Now Pairing...

2. Enable (turn on) the BLUETOOTH function of the BLUETOOTH wireless technology enabled device, then select this unit from amongst the devices displayed. If a password is requested, enter "0000".
  - This unit is displayed as "Integra DTM-7 XXXXXX".
  - To connect another BLUETOOTH

wireless technology enabled device, press and hold Bluetooth until "Now Pairing..." is displayed, then perform step 2. This unit can store the data of up to eight paired devices.

- The coverage area is 48'/15 meters. Note that connection is not always guaranteed with all BLUETOOTH wireless technology enabled devices.

## Playing Back

1. Perform the connection procedure on the BLUETOOTH wireless technology enabled device. The input on this unit automatically switches to "BLUETOOTH".
2. Play the music files. Increase the volume of the BLUETOOTH wireless technology enabled device to an appropriate level.
  - Due to the characteristics of BLUETOOTH wireless technology, the sound produced on this unit may slightly be behind the sound played on the BLUETOOTH wireless technology

enabled device.

## Internet Radio

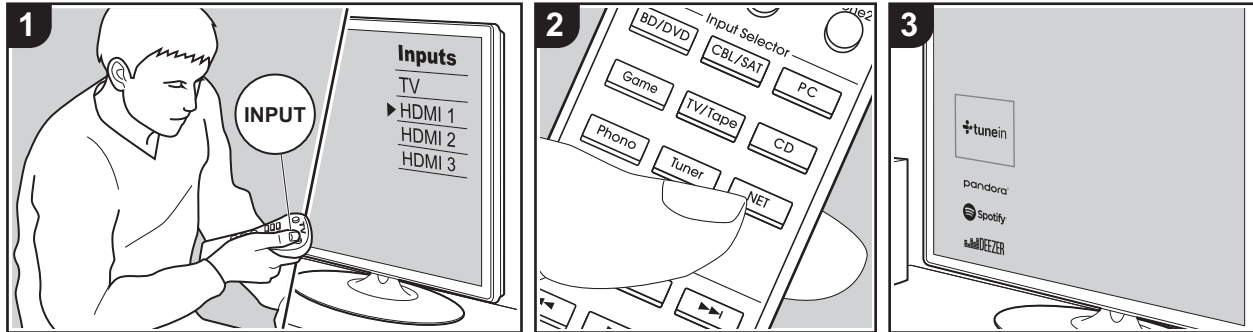

You can use internet radio services such as TuneIn Radio, Pandora, Deezer, and TIDAL by connecting this unit to a network that has an internet connection.

- The network needs to be connected to the internet in order to play internet radio services.
- Depending on the internet radio service, the user may need to register from their computer first. Refer to the websites for each of the services for details about them.
- Functionality may be introduced by firmware updates and service providers may cease services, meaning that some network services and content may become unavailable in the future.

### Playing Back

Perform the following procedure when the unit is on.

1. Switch the input on the TV to that assigned to the unit.
2. Press NET (a) on the remote controller

to display a list of Network Functions on the TV.

3. Select the internet radio service you want with the cursors of the remote controller and press Enter (b) to confirm your selection.
4. Follow the on-screen instructions, using the cursors to select radio stations and programs, then press Enter to play (b). Play starts when 100% is displayed for buffering.
- To return to the previous screen, press Return (c).

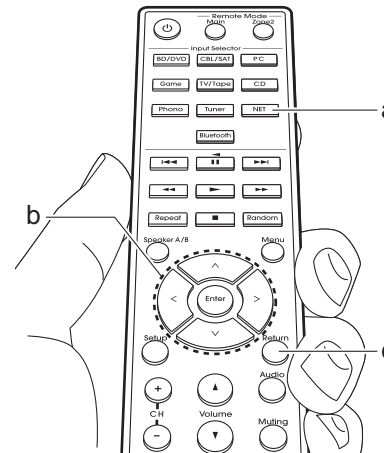

### Internet radio service menus

You can register certain stations as your favorites or delete stations you have registered from your favorites. The menu displayed depends on the service currently selected.

Menu icons (☺) are displayed at the bottom right of the screen while playing a station. The menu is displayed on the screen if you press the Menu button on the remote controller at this time.

### Regarding the TuneIn Radio Account

Creating an account on the TuneIn Radio website ([tunein.com](http://tunein.com)) and logging in from the unit allows you to automatically add your favorite radio stations and programs to your "My Presets" on the unit as you follow them on the website. "My Presets" are displayed in the level under TuneIn Radio.

To display a radio station registered in "My



Presets", you must log into TuneIn Radio from the unit. To log in, select "Login" - "I have a TuneIn account" in the "TuneIn Radio" top list on the unit, and then enter your user name and password.

- If you select "Login" on this unit, you can use the displayed registration code to associate this device on the My Page section of the TuneIn Radio website so that you can login to "Login" - "Login with a registration code" without having to enter your user name and password.



## Spotify

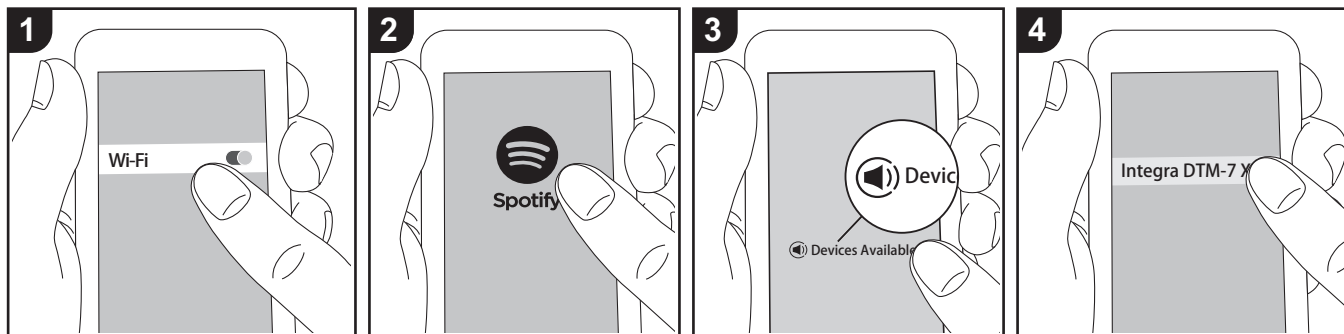

Spotify Connect play is possible by connecting this unit to the same network as a smart phone or tablet.

- To play Spotify Connect, you need to install the Spotify application on your smartphone or tablet. You also need to create a Spotify premium account.
  - Refer to the following for Spotify settings: [www.spotify.com/connect/](http://www.spotify.com/connect/)

### Playing Back

1. Connect the smartphone to the access point that this unit is connected to.
2. Start the Spotify app.
3. Play the track in the Spotify app, then after switching to the screen for controlling play, tap "Devices Available" at the bottom of the screen.
4. Select this unit.
5. This unit turns on automatically and the input selector changes to NET and streaming of Spotify starts.
  - If "5. Hardware" - "Power Management" - "Network Standby" is set to "Off" in the

Setup menu, manually turn the unit on and then press NET on the remote controller.

### Notes for using multi-zone

- To enjoy Spotify in a separate room, manually select "NET" as the input of the separate room. After doing that, select this unit with the Spotify app.
- To enjoy Spotify in the main room after playing Spotify in a separate room, select "NET" as the input of the main room.

# AirPlay®

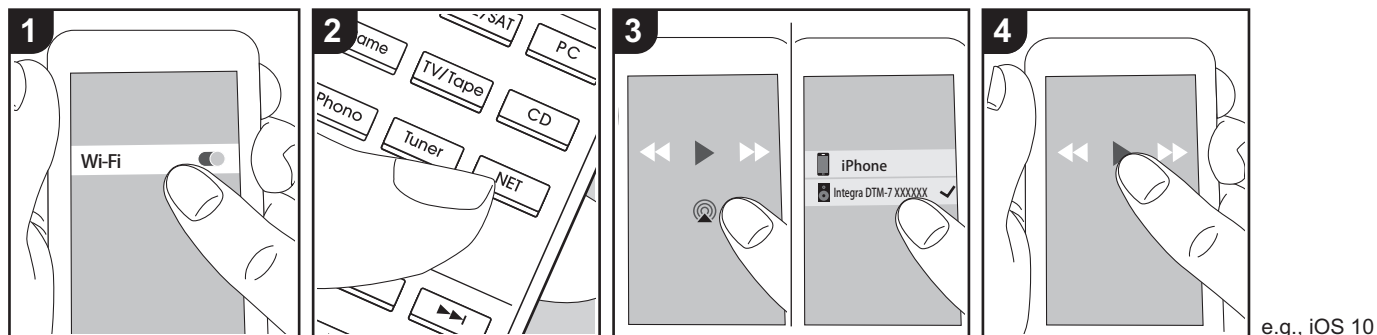

## Basic operations

You can wirelessly enjoy the music files on an iPhone®, iPod touch®, or iPad® connected to the same access point as this unit.

- Update the OS version on your iOS device to the latest version.
  - There may be some differences in the operations screens and how operations are performed on the iOS device depending on the iOS version. For details, see the operating instructions for the iOS device.
1. Connect the iOS device to the access point.
  2. Press NET.
  3. Tap the AirPlay icon  in the play screen of the music app on the iOS device and select this unit from the list of devices displayed.
  4. Play the music files on the iOS device.
    - The default status is for the Network Standby feature to be on, so when you do steps 3 and 4 above, this unit

automatically comes on and input switches to "NET". To reduce the amount of power consumed in standby mode, press the Setup button on the remote controller, then in the Setup menu displayed set "5. Hardware" - "Power Management" - "Network Standby" to "Off".

- Due to the characteristics of AirPlay wireless technology, the sound produced on this unit may slightly be behind the sound played on the AirPlay-enabled device.

You can also play the music files on a computer with iTunes (Ver. 10.2 or later). Before operation, make sure this unit and the PC are connected to the same network, then press NET on this unit. Next, click the AirPlay icon  in iTunes, select this unit from the list of devices displayed, and start play of a music file.

## USB Storage Device

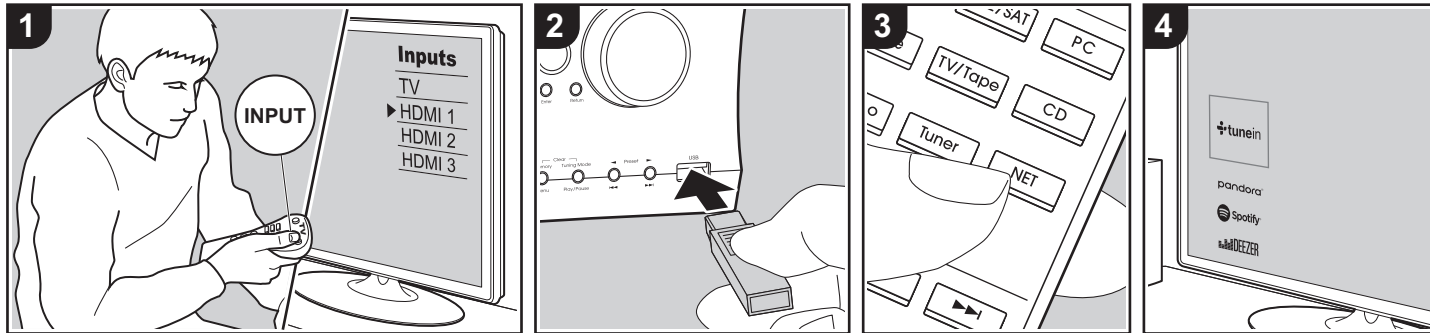

### Basic operations

You can play music files stored on a USB storage device.

Perform the following procedure when the unit is on.

1. Switch the input on the TV to that assigned to the unit.
2. Plug your USB storage device with the music files into the USB port either on the front panel or rear panel of this unit.
3. Press NET (a) on the remote controller to display the network service list screen.
4. With the cursors on the remote controller, select "USB Front" "USB Rear", and then press Enter (b).
  - If the "USB" indicator flashes on the display, check whether the USB storage device is plugged in properly.
  - Do not unplug the USB storage device while "Connecting..." is on the display. This may cause data corruption or malfunction.

5. Press Enter on the remote controller again in the next screen. The list of folders and music files on the USB storage device are displayed. Select the folder with the cursors and press Enter to confirm your selection.
6. With the cursors on the remote controller, select the music file, and then press Enter to start playback.
  - To return to the previous screen, press Return (c).
  - The USB port of this unit conforms with the USB 2.0 standard. The transfer speed may be insufficient for some content you play, which may cause some interruption in sound.
  - Note that operation is not guaranteed with all USB storage devices.
  - This unit can use USB storage devices that comply with the USB mass storage device class standard. The unit is also compatible with USB storage devices using the FAT16 or FAT32 file system formats.

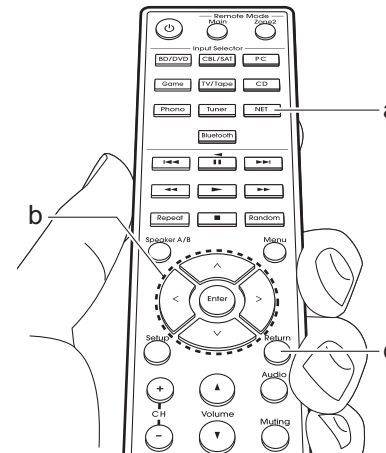



## Listening To the AM/FM Radio

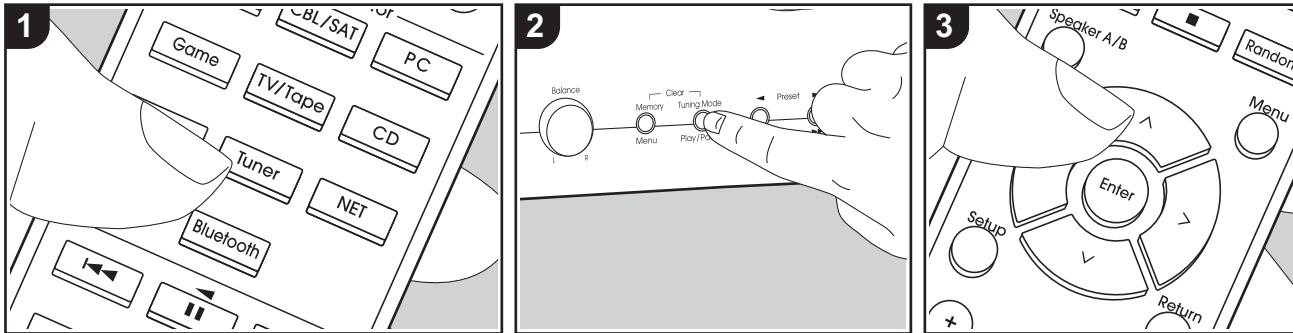

You can receive FM and AM radio stations on this unit with the built-in tuner. Perform the following procedure when the unit is on.

### ■ Tuning into a Radio Station

#### Tuning Automatically

1. Repeatedly press Tuner (a) on the remote controller and select "AM" or "FM".
2. Press Tuning Mode on the main unit so that "TunMode:Auto" appears on the display.

TunMode:Auto

3. When you press the cursor  $\wedge/\vee$  buttons (b) on the remote controller, automatic tuning starts, and searching stops when a station is found. When tuned into a radio station, the "TUNED" indicator on the display lights. When tuned into a stereo FM radio station, the

"FM ST" indicator lights.

**When FM broadcasts reception is poor:** Perform the procedure for "Tuning Manually" in the following section. Note that if you tune manually, the reception for FM broadcasts will be monaural rather than stereo, irrespective of the sensitivity of the reception.

#### Tuning Manually

If you tune manually, the reception for FM broadcasts will be monaural rather than stereo, irrespective of the sensitivity of the reception.

1. Repeatedly press Tuner (a) on the remote controller and select "AM" or "FM".
2. Press Tuning Mode on the main unit so that "TunMode:Manual" appears on the display.

TunMode:Manual

3. While pressing the cursor  $\wedge/\vee$  buttons (b) on the remote controller, select the desired radio station.
  - The frequency changes by 1 step each time you press  $\wedge/\vee$ . The frequency changes continuously if the button is held down and stops when the button is released.

#### Frequency step setting:

Press Setup on the remote controller, then use the cursor buttons and Enter on the remote controller to select "7. Miscellaneous" - "Tuner" - "AM / FM Frequency Step", and select the frequency step for your region. Note that when this setting is changed, all radio presets are deleted.

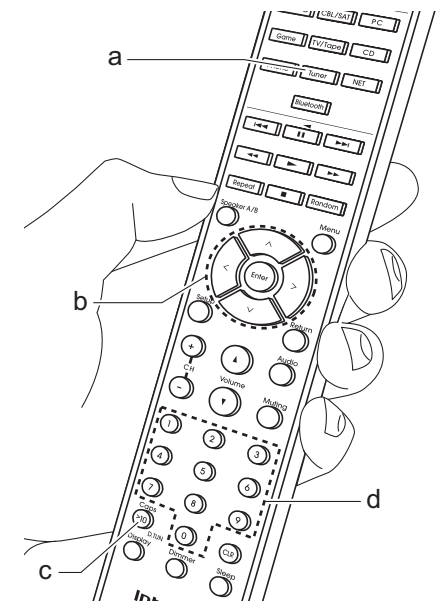

### Tuning into stations by frequency

It allows you to directly enter the frequency of the radio station you want to listen to.

1. Press the Tuner button (a) of the remote controller repeatedly to select either "AM" or "FM".
2. Press D.TUN button (c) on the remote controller.
3. Using the number buttons (d) on the remote controller, enter the frequency of the radio station within 8 seconds.
  - To enter 87.5 (FM), for example, press 8, 7, 5 or 8, 7, 5, 0. If the entered number is incorrect, press the D.TUN button again and re-enter the number.

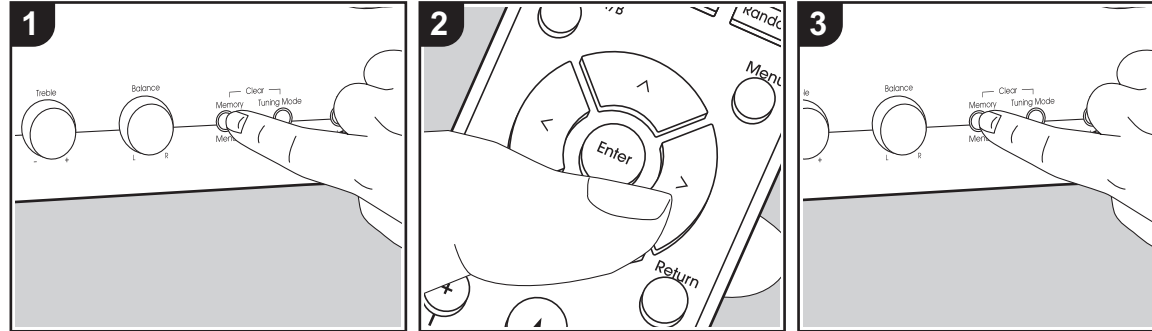

### ■ Registering a station

You can register up to 40 of your favorite AM/FM radio stations.

#### Registering

After tuning into the AM/FM radio station you want to register, perform the following procedure.

1. Press Memory on the main unit so that the preset number on the display flashes.

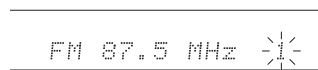

2. While the preset number is flashing (about 8 seconds), repeatedly press the cursor </> buttons (b) on the remote controller to select a number between 1 and 40.
3. Press Memory again on the main unit to register the station. When the station is registered, the

preset number stops flashing. Repeat this procedure for all of your favorite AM/FM radio stations.

#### Selecting a Preset Radio Station

1. Press Tuner (a) on the remote controller.
2. Press the cursor </> buttons (b) on the remote controller to select a preset number.

#### Deleting a Preset Radio Station

1. Press Tuner (a) on the remote controller.
2. Press the cursor </> buttons (b) on the remote controller to select the preset number to delete.
3. While pressing Memory on the main unit, press Tuning Mode to delete the preset number. When deleted, the number on the display goes off.

# Music Server

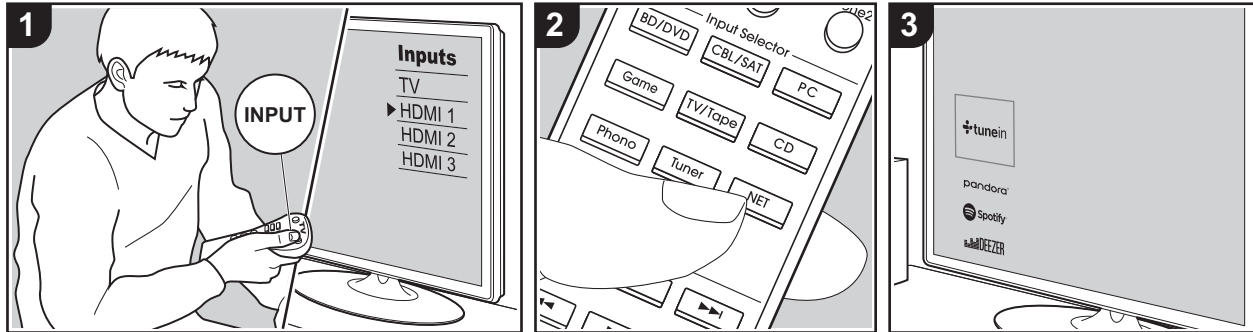

It is possible to stream music files stored on PCs or NAS devices connected to the same network as this unit.

- The network servers compatible with the Music Server feature are those PCs with players installed that have the server functionality of Windows Media® Player 11 or 12, or NAS that are compatible with home network functionality. Note that with PCs, only music files registered in the library of Windows Media® Player can be played.
- You may need to make some settings on the PC in advance to use Windows Media® Player 11 or 12 with the Music Server feature.

## ■ Windows Media® Player settings

### On Windows Media® Player 11

1. Turn on your PC and start Windows Media® Player 11.
2. In the "Library" menu, select "Media Sharing" to display a dialog box.
3. Select the "Share my media" check box, and then click "OK" to display the compatible devices.
4. Select this unit, click "Allow" and put a check mark next to the icon for this unit.
5. Click "OK" to close the dialog.
  - Depending of the version of Windows Media® Player, there may be differences in the names of items you can select.

### On Windows Media® Player 12

1. Turn on your PC and start Windows Media® Player 12.
2. In the "Stream" menu, select "Turn on media streaming" to display a dialog box.

- If media streaming is already turned on, select "More streaming options..." in the "Stream" menu to list players in the network, and then go to step 4.
- 3. Click "Turn on media streaming" to list players in the network.
- 4. Select this unit in "Media streaming options" and check that it is set to "Allow".
- 5. Click "OK" to close the dialog.
- Depending of the version of Windows Media® Player, there may be differences in the names of items you can select.

## ■ Playing Back

Before performing the operations below, start the server (Windows Media® Player 11, Windows Media® Player 12, or NAS device) containing the music files to play, and make sure that the PCs and/or NASs are properly connected to the same network as this unit.

Perform the following procedure when the unit is on.

1. Switch the input on the TV to that assigned to the unit.
2. Press NET (a) on the remote controller to display a list of Network Functions on the TV.
3. Select "Music Server" with the cursors of the remote controller and press Enter to confirm your selection (b).
4. Select the target server with the cursors on the remote controller and press Enter to display the items list screen.
5. With the cursors on the remote controller, select the music file to play,



and then start playback with Enter.

- To return to the previous screen, press Return (c).
- If "No Item." is displayed, check whether the network is properly connected.
- Depending on the server and share settings, the unit may not recognize it, or may not be able to play its music files. Furthermore, the unit cannot access pictures and videos stored on servers.
- For music files on a server, there can be up to 20,000 tracks per folder, and folders may be nested up to 16 levels deep.

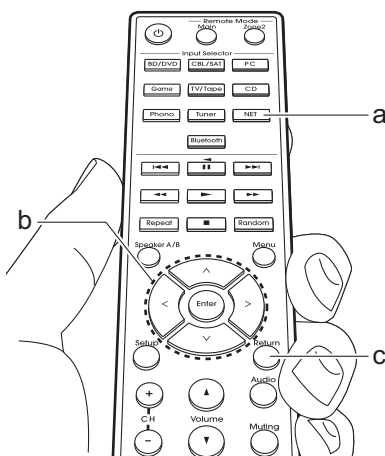

### ■ Controlling Remote Playback from a PC

You can use this unit to play music files stored on your PC by operating the PC inside your home network. The unit supports remote playback with Windows Media® Player 12.

1. Turn on your PC and start Windows Media® Player 12.
2. Open the "Stream" menu and check that "Allow remote control of my Player..." is checked. Click "Turn on media streaming" to list players in the network.
3. Switch the input on the TV to that assigned to the unit.
4. Select and right-click the music file to play with Windows Media® Player 12. To remotely play a music file on another server, open the target server from "Other Libraries" and select the music file to play.
5. Select this unit in "Play to" to open the "Play to" window of Windows Media® Player 12 and start playback on the unit. If your PC is running on Windows® 8.1, click "Play to", and then select this unit. If your PC is running on Windows® 10, click "Cast to Device", and select this unit. Operations during remote playback are possible from the "Play to" window on the PC. The playback screen is displayed on the TV connected to the HDMI output of the unit.
6. Adjust the volume using the volume bar on the "Play to" window.
  - Sometimes, the volume displayed on the remote playback window may differ from that appeared on the display of the unit.

Also, when the volume is adjusted from this unit, this is not reflected in the "Play to" window.

- Remote playback is not possible when using a network service or playing music files on a USB storage device.
- Depending of the version of Windows®, there may be differences in the names of items you can select.

## Multi-zone

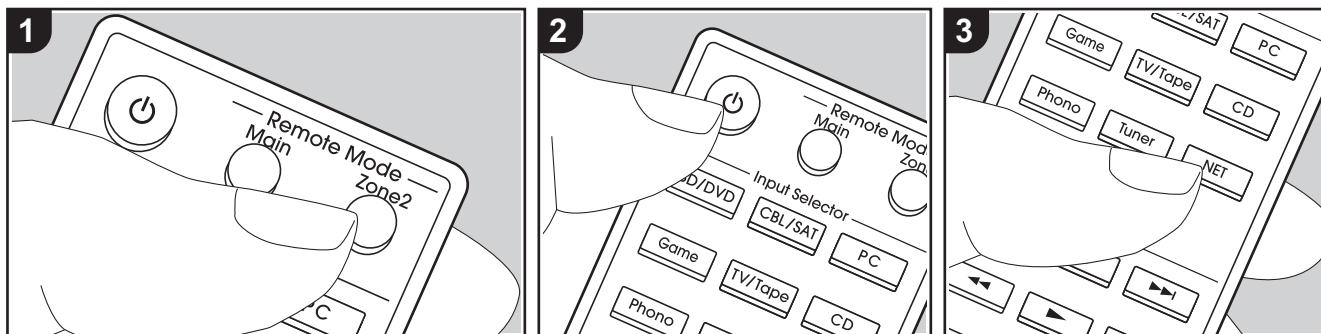

### Basic operations

You can enjoy audio in the separate room by, for example, playing a Blu-ray Disc player in the main room (where this unit is located) and listening to internet radio in the separate room (ZONE 2).

- DSD audio signals are not output to ZONE 2 with the "NET" input selector.
- You can only select the same inputs for the main room and separate room with the "NET" or "BLUETOOTH" input selector. If you have "NET" selected in the main room and then select "BLUETOOTH" in the separate room, the main room also switches to "BLUETOOTH". You cannot select different stations for the main room and separate room with the AM/FM radio.
- If ZONE 2 is on, power consumption during standby becomes larger than normal. Furthermore, RI linking features do not work.

Perform the following procedure when the unit is on.

1. Press Remote Mode Zone 2 (a) on the remote controller.
  - The remote controller switches to the mode for controlling ZONE 2.
2. Face the remote controller at this unit and press  $\odot$  (c).  
The "Z2" indicator on the display lights.
3. Press the input selector (d) of the input you want to play in the separate room.
  - On the main unit, after pressing Zone 2, within 8 seconds turn the Input dial to select the input to be played in the separate room. To play the same source in the main room and separate room, press Zone 2 on the main unit twice.
4. Adjust the volume on the pre-main amplifier for the separate room.

### To turn off the function:

Press the  $\odot$  button while the remote controller is in the mode for controlling ZONE 2. Alternatively press Off on the main unit.

### Playing in ZONE 2 only:

If you turn the unit to standby during multi-zone playback, the Z2 indicator is dimmed and the playback mode is switched to playback in a separate room only. Turning ZONE 2 on while the unit is in standby also switches the playback mode to playback in a separate room only.

- i** To return the remote controller to main room control mode: Press Remote Mode Main (b) on the remote controller.

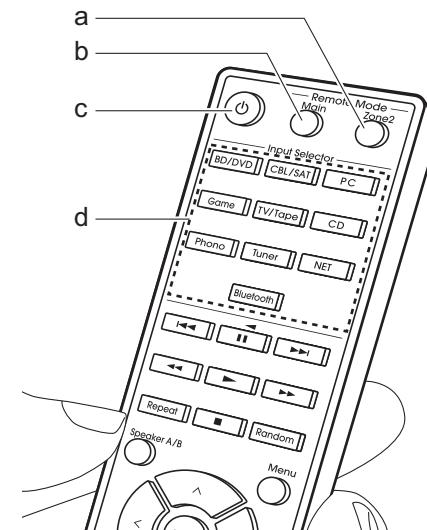



## Supplementary information for player functions

Due to firmware (the software for the system) updates after you make your purchase or firmware changes during production of the product, there may be additions or changes to the features available compared to what is in the instruction manual.

For information about player functions that have been added or changed, see the following references. Refer to "Supplementary Information" (P50) for information about changes to settings, etc., other than player functions.

[Supplementary information for player functions](#)

>>> [Click here](#) <<<



# Setup Menu

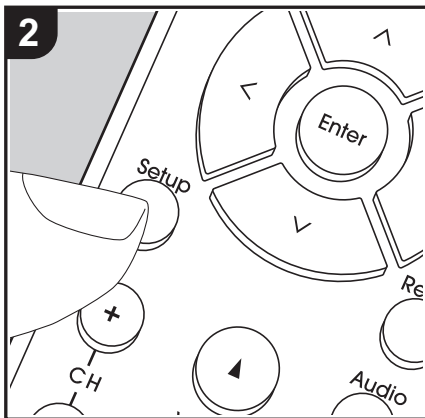
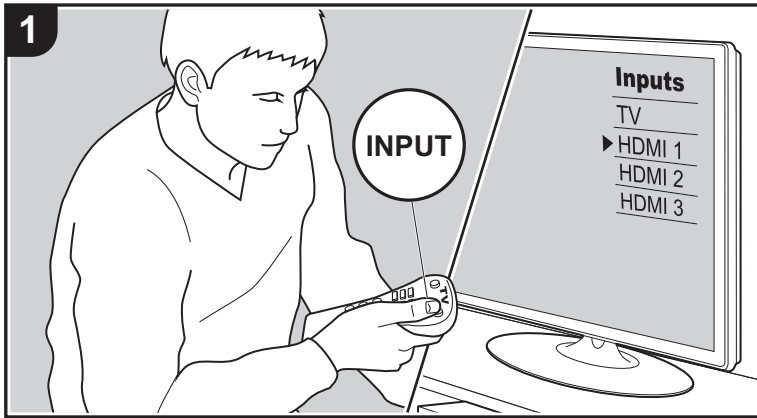

The unit allows you to configure advanced settings to provide you with an even better experience.

1. Switch the input on the TV to that assigned to the unit.
2. Press Setup on the remote controller to display the Setup menu screen.

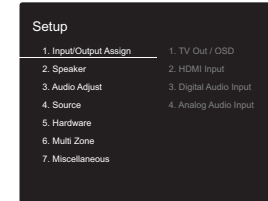

3. Select the item with  $\wedge$  /  $\vee$  on the remote controller and press Enter to confirm your selection.
  - Change the initial values for each of the settings with the cursors  $<$  /  $>$ .
  - To return to the previous screen, press Return.
4. To exit the settings, press Setup.

## 1. Input/Output Assign

### ■ 1. TV Out / OSD

OSD Language	Select the on-screen display language. English, German, French, Spanish, Italian, Dutch, Swedish
Impose OSD	Set whether or not to display the information on the TV when the volume is adjusted or input is changed, for example. "On (default value)": Display OSD on the TV "Off": Do not display OSD on the TV <ul style="list-style-type: none"> <li>• OSD may not be displayed depending on the input signal even if "On" is selected. If the operation screen is not displayed, change the resolution of the connected device.</li> </ul>



Mini Player OSD	<p>You can play on the TV the images from another input selected immediately prior while you are playing the audio from NET or BLUETOOTH input. After switching to NET or BLUETOOTH, play the images and audio, then when you press Caps on the remote controller, the image is displayed in full-screen mode, and the audio information (Mini Player) for NET or BLUETOOTH is displayed in the corner of the screen. You can set whether to display this Mini Player on the screen all the time.</p> <p>"Always On (default value)": The Mini Player is displayed all the time.</p> <p>"Auto Off": The Mini Player turns off automatically 30 seconds after being displayed. It is displayed for 30 seconds after operations such as changing the volume.</p> <ul style="list-style-type: none"> <li>• Each press of the Caps button displays or turns off the video.</li> <li>• This cannot be selected if "Impose OSD" is set to "Off".</li> </ul>
Screen Saver	<p>Set the time to start the screen saver.</p> <p>Select "3 minutes (default value)", "5 minutes", "10 minutes", or "Off".</p>

## ■ 2. HDMI Input

You can change input assignment between the input selectors and HDMI IN jacks.

BD/DVD	"HDMI 1 (HDCP 2.2)" to "HDMI 4 (HDCP 2.2)": Assign a desired HDMI IN jack to the BD/DVD input selector. If you do not assign a jack, select "---". To select an HDMI IN jack already assigned to another input selector, change the input selector setting to "---" first. (Default Value is "HDMI 1 (HDCP 2.2)")
CBL/SAT	"HDMI 1 (HDCP 2.2)" to "HDMI 4 (HDCP 2.2)": Assign a desired HDMI IN jack to the CBL/SAT input selector. If you do not assign a jack, select "---". To select an HDMI IN jack already assigned to another input selector, change the input selector setting to "---" first. (Default Value is "HDMI 2 (HDCP 2.2)")
GAME	"HDMI 1 (HDCP 2.2)" to "HDMI 4 (HDCP 2.2)": Assign a desired HDMI IN jack to the GAME input selector. If you do not assign a jack, select "---". To select an HDMI IN jack already assigned to another input selector, change the input selector setting to "---" first. (Default Value is "HDMI 4 (HDCP 2.2)")

PC	"HDMI 1 (HDCP 2.2)" to "HDMI 4 (HDCP 2.2)": Assign a desired HDMI IN jack to the PC input selector. If you do not assign a jack, select "---". To select an HDMI IN jack already assigned to another input selector, change the input selector setting to "---" first. (Default Value is "HDMI 3 (HDCP 2.2)")
CD	"HDMI 1 (HDCP 2.2)" to "HDMI 4 (HDCP 2.2)": Assign a desired HDMI IN jack to the CD input selector. If you do not assign a jack, select "---". To select an HDMI IN jack already assigned to another input selector, change the input selector setting to "---" first. (Default Value is "---")
TV/TAPE	"HDMI 1 (HDCP 2.2)" to "HDMI 4 (HDCP 2.2)": Assign a desired HDMI IN jack to the TV/TAPE input selector. If you do not assign a jack, select "---". To select an HDMI IN jack already assigned to another input selector, change the input selector setting to "---" first. (Default Value is "---")
PHONO	"HDMI 1 (HDCP 2.2)" to "HDMI 4 (HDCP 2.2)": Assign a desired HDMI IN jack to the PHONO input selector. If you do not assign a jack, select "---". To select an HDMI IN jack already assigned to another input selector, change the input selector setting to "---" first. (Default Value is "---")

## ■ 3. Digital Audio Input

You can change input assignment between the input selectors and DIGITAL IN COAXIAL/OPTICAL jacks. If you do not assign a jack, select "---".

BD/DVD	"COAXIAL", "OPTICAL 1", "OPTICAL 2": Assign a desired DIGITAL IN jack to the BD/DVD input selector. (Default Value is "---")
CBL/SAT	"COAXIAL", "OPTICAL 1", "OPTICAL 2": Assign a desired DIGITAL IN jack to the CBL/SAT input selector. (Default Value is "---")
GAME	"COAXIAL", "OPTICAL 1", "OPTICAL 2": Assign a desired DIGITAL IN jack to the GAME input selector. (Default Value is "OPTICAL 1")





PC	"COAXIAL", "OPTICAL 1", "OPTICAL 2": Assign a desired DIGITAL IN jack to the PC input selector. (Default Value is "----")
CD	"COAXIAL", "OPTICAL 1", "OPTICAL 2": Assign a desired DIGITAL IN jack to the CD input selector. (Default Value is "COAXIAL")
TV/TAPE	"COAXIAL", "OPTICAL 1", "OPTICAL 2": Assign a desired DIGITAL IN jack to the TV/TAPE input selector. (Default Value is "OPTICAL 2")
PHONO	"COAXIAL", "OPTICAL 1", "OPTICAL 2": Assign a desired DIGITAL IN jack to the PHONO input selector. (Default Value is "----")

- Supported sampling rates for PCM signals (stereo, mono) from a digital input are 32 kHz, 44.1 kHz, 48 kHz, 88.2 kHz, 96 kHz/16 bit, 20 bit, 24 bit.

#### ■ 4. Analog Audio Input

You can change input assignment between the input selectors and AUDIO IN jacks. If you do not assign a jack, select "----".

BD/DVD	"AUDIO 1", "AUDIO 2", "AUDIO 3": Assign a desired AUDIO IN jack to the BD/DVD input selector. (Default Value is "----")
CBL/SAT	"AUDIO 1", "AUDIO 2", "AUDIO 3": Assign a desired AUDIO IN jack to the CBL/SAT input selector. (Default Value is "----")
GAME	"AUDIO 1", "AUDIO 2", "AUDIO 3": Assign a desired AUDIO IN jack to the GAME input selector. (Default Value is "----")
PC	"AUDIO 1", "AUDIO 2", "AUDIO 3": Assign a desired AUDIO IN jack to the PC input selector. (Default Value is "AUDIO 1")
CD	"AUDIO 1", "AUDIO 2", "AUDIO 3": Assign a desired AUDIO IN jack to the CD input selector. (Default Value is "AUDIO 3")
TV/TAPE	"AUDIO 1", "AUDIO 2", "AUDIO 3": Assign a desired AUDIO IN jack to the TV/TAPE input selector. (Default Value is "AUDIO 2")
PHONO	This setting is fixed at "PHONO" and cannot be changed.

## 2. Speaker

You can make changes to the connection environment of the speakers and volume level, etc. This setting cannot be selected if headphones are connected or if "5. Hardware" - "HDMI" - "Audio TV Out" is set to "On" so audio is output from the speakers of the TV.

### ■ 1. Configuration

Subwoofer	Set whether a subwoofer is connected or not. "Yes (default value)": When subwoofer is connected "No": When subwoofer is not connected
Speaker Impedance	Set the impedance of the connected speakers. "4ohms": When any of the connected speakers have 4 Ω or more to less than 6 Ω impedance, or when a set of left and right speakers are connected to each of the SPEAKERS A/B terminals "6ohms (default value)": When the connected speakers all have 6 Ω or more impedance <ul style="list-style-type: none"> <li>For impedance, check the indications on the back of the speakers or their instruction manual.</li> </ul>

### ■ 2. Crossover

Front	Select the crossover frequency from "40Hz" to "200Hz" to start outputting frequencies for each channel. (Default Value is "100Hz") "Full Band": Full band will be output. <ul style="list-style-type: none"> <li>If "Configuration" - "Subwoofer" is set to "No", "Front" will be fixed to "Full Band".</li> </ul>
Double Bass	This can be selected when the "Front" setting is "Full Band". Boost bass output by sending the bass of the front speakers to the subwoofer. "On": Bass output will be boosted. "Off": Bass output will not be boosted.

- This setting cannot be selected when you have set "Configuration" - "Subwoofer" to "No".



### ■ 3. Distance

Set the distance from each speaker to the listening position.

Front Left	Specify the distance between each speaker and the listening position. (Default Value is "12.0 ft")
Front Right	Specify the distance between each speaker and the listening position. (Default Value is "12.0 ft")
Subwoofer	Specify the distance between each speaker and the listening position. (Default Value is "12.0 ft")

- Distance units can be switched by pressing Caps on the remote controller. When the unit is set as feet, you can set between 0.1 ft and 30.0 ft in increments of 0.1 ft. When the unit is set as meters, you can set between 0.03 m and 9.00 m in increments of 0.03 m.

### ■ 4. Level Calibration

Front Left	Select a value between "-12.0 dB" and "+12.0 dB" (in 0.5 dB increments). A test tone will be output each time you change the value. Select the desired level. (Default Value is "0.0 dB")
Front Right	Select a value between "-12.0 dB" and "+12.0 dB" (in 0.5 dB increments). A test tone will be output each time you change the value. Select the desired level. (Default Value is "0.0 dB")
Subwoofer	Select a value between "-15.0 dB" and "+12.0 dB" (in 0.5 dB increments). A test tone will be output each time you change the value. Select the desired level. (Default Value is "0.0 dB")

## 3. Audio Adjust

### ■ 1. Volume

Mute Level	Set the volume lowered from the listening volume when muting is on. Select a value from "-∞dB (default value)", "-40dB", and "-20dB".
Maximum Volume	Set the maximum value to avoid too high volume. Select "Off (default value)" or a value between "50" to "99".

Power On Volume	Set the volume level of when the power is turned on. Select "Last (default value)" (volume level before entering standby mode), "Min", "0.5" to "99.5" and "Max". <ul style="list-style-type: none"> <li>You cannot set a higher value than that of "Maximum Volume".</li> </ul>
Headphone Level	Adjust the output level of the headphones. Select from "-12.0 dB" to "+12.0 dB". (Default Value is "0.0 dB")

## 4. Source

### ■ 1. IntelliVolume

Adjust the volume level difference between the devices connected to the unit. Select the input selector to configure.

IntelliVolume	Select from "-12.0 dB" to "+12.0 dB". Set a negative (–) value if the volume of the target device is larger than the others and a positive (+) value if smaller. To check the audio, start playback of the connected device. (Default Value is "0.0 dB") <ul style="list-style-type: none"> <li>This function is not effective in ZONE 2.</li> </ul>
---------------	--

### ■ 2. Name Edit

Set an easy name to each input. The set name will be shown on the main unit display. Select the input selector to configure.

Name Edit	<ol style="list-style-type: none"> <li>Select a character or symbol with the cursors and press Enter. Repeat it to input 10 or less characters.                     <ul style="list-style-type: none"> <li>"A/a": Switches between upper and lower cases. (Pressing Caps on the remote controller also toggles between upper and lower cases.)</li> <li>"←" "→": Moves the cursor to the arrow direction.</li> <li>"&lt;⊗&gt;": Removes a character on the left of the cursor.</li> <li>"␣": Enters a space.                             <ul style="list-style-type: none"> <li>Pressing CLR on the remote controller will remove all the input characters.</li> </ul> </li> </ul> </li> <li>After inputting, select "OK" with the cursors and press Enter. The input name will be saved.</li> </ol>
-----------	--



- To name a preset radio station, press Tuner on the remote controller, select AM/FM and select the preset number.
- It cannot be set if the "NET" or "BLUETOOTH" input is selected.

### ■ Audio Select

Select the priority for input selection when multiple audio sources are connected to one input selector, such as connections to both the "PC" HDMI IN jack and the "PC" AUDIO IN jack. The setting can be separately set to each input selector. Select the input selector to configure.

Audio Select	<p>"ARC": When giving priority to input signal from ARC compatible TV.</p> <ul style="list-style-type: none"> <li>• The setting can be selected only when "5. Hardware" - "HDMI" - "Audio Return Channel" is set to "Auto" and also the "TV/TAPE" input is selected.</li> </ul> <p>"HDMI": When giving priority to input signal from HDMI IN jacks.</p> <ul style="list-style-type: none"> <li>• The setting can be selected only when the input is assigned to the HDMI jack in the "1. Input/Output Assign" - "HDMI Input" setting.</li> </ul> <p>"COAXIAL": When giving priority to input signal from DIGITAL IN COAXIAL jacks.</p> <ul style="list-style-type: none"> <li>• The setting can be selected only when the input is assigned to the COAXIAL jack in the "1. Input/Output Assign" - "Digital Audio Input" setting.</li> </ul> <p>"OPTICAL": When giving priority to input signal from DIGITAL IN OPTICAL jacks.</p> <ul style="list-style-type: none"> <li>• The setting can be selected only when the input is assigned to the OPTICAL jack in the "1. Input/Output Assign" - "Digital Audio Input" setting.</li> </ul> <p>"Analog": To always output analog audio independently of the input signal</p> <ul style="list-style-type: none"> <li>• The setting can be selected only when the input is assigned to the AUDIO jack in the "1. Input/Output Assign" - "Analog Audio Input" setting.</li> </ul> <p>(Default value: BD/DVD: HDMI, CBL/SAT: HDMI, GAME: HDMI, PC: HDMI, CD: COAXIAL, TV/TAPE: OPTICAL, PHONO: Analog)</p>
--------------	---

- This setting cannot be changed if the "TUNER", "NET" or "BLUETOOTH" input is selected.

### ■ Video Select

When "TUNER", "NET", or "BLUETOOTH" input is selected, you can set the input from which video is displayed on the TV.

Video Select	<p>"Last (default value)": Select the video input played immediately prior.</p> <p>"BD/DVD", "CBL/SAT", "GAME", "PC", "CD", "TV/TAPE", "PHONO": Play the video from the selected input.</p> <ul style="list-style-type: none"> <li>• This setting is effective for input selectors assigned in "1. Input/Output Assign" - "HDMI Input".</li> </ul>
--------------	--



## 5. Hardware

### ■ 1. HDMI

HDMI CEC	<p>Setting to "On" enables the input selection link and other link functions with HDMI connected CEC compliant device.</p> <p>"On": When this function is to be used          "Off (default value)": When this function is not to be used</p> <p>When changing this setting, turn off and then on again the power of all connected components.</p> <ul style="list-style-type: none"> <li>Depending on the TV you have, link settings may be needed on the TV.</li> <li>Setting to "On" and closing the on-screen menu displays the name of the CEC-compatible components and "CEC On" on the display.</li> <li>Power consumption in standby mode may increase if "On" is set. (Depending on the TV status, the unit will enter the normal standby mode.)</li> <li>If you operate the volume dial on this unit when this setting is "On" and audio is output from the TV speakers, audio will be output also from the speakers connected to the unit. If you want to output from only one of them, change the unit or TV settings, or reduce the volume of the unit.</li> <li>If abnormal operation occurs when you set the setting to "On", set it to "Off".</li> <li>When connecting a non-CEC compatible component, or when you are not sure whether it is compatible, set the setting to "Off".</li> </ul>
----------	--

HDMI Standby Through	<p>When this is set to anything other than "Off", you can play the video and audio of an HDMI connected player on the TV even if the unit is in standby mode. Only "Auto" and "Auto (Eco)" can be selected if "HDMI CEC" is set to "On". If you select anything else, set "HDMI CEC" to "Off". (Default Value is "Off")</p> <ul style="list-style-type: none"> <li>Power consumption when this unit is in standby mode increases if set to anything other than "Off".</li> </ul> <p>"BD/DVD", "CBL/SAT", "GAME", "PC", "CD", "TV/TAPE", "PHONO": For example, if you select "BD/DVD", you can play the equipment connected to the "BD/DVD" jack on the TV even if the unit is in standby mode. Select this setting if you have decided which player to use with this function.</p> <p>"Last": You can play the video and audio of the input selected immediately prior to the unit being switched to standby on the TV.</p> <p>"Auto", "Auto (Eco)": Select one of these settings when you have connected equipment that conforms to the CEC standard. You can play the video and audio of the input selected on the TV, irrespective of what input was selected immediately prior to the unit being switched to standby, using the CEC link function.</p> <ul style="list-style-type: none"> <li>To play players on the TV that do not conform to the CEC standard, you will need to turn the unit on and switch to the relevant input.</li> <li>When using a TV that conforms to the CEC standard, you can reduce the power consumption in standby mode by selecting "Auto (Eco)".</li> </ul>
----------------------	---



Audio TV Out	<p>You can enjoy audio through the speakers of the TV while this unit is on.</p> <p>"On": When this function is to be used          "Off (default value)": When this function is not to be used</p> <ul style="list-style-type: none"> <li>• The setting is fixed to "Auto" if "HDMI CEC" is set to "On". If you change this setting, set "HDMI CEC" to "Off"</li> <li>• Depending on your TV set or input signal of the component, audio may not output through the speakers of the TV even if this setting is set to "On". In such case, audio is output from the speakers of the unit.</li> <li>• If you operate the volume dial on this unit when audio that is being input through this unit for output from the TV speakers, audio is output from this unit. If you do not want to output audio from the unit, change the unit or TV settings, or reduce the volume of the unit.</li> </ul>
Audio Return Channel	<p>You can enjoy sound of the HDMI connected ARC compatible TV through the speakers connected to the unit.</p> <p>To use this function, set "HDMI CEC" to "On" in advance.</p> <p>"Auto": To enjoy the TV sound through the speakers connected to this unit          "Off": When not using the ARC function</p>
Auto Lip Sync	<p>This setting automatically corrects any desynchronization between the video and audio signals based on data from the HDMI LipSync compatible TV.</p> <p>"On (default value)": Automatic correction will be enabled.          "Off": Automatic correction will be disabled.</p>

Wi-Fi Setup	<p>You can configure wireless LAN settings by pressing Enter when "Start" is displayed.</p> <ul style="list-style-type: none"> <li>• Refer to "2. Network Connection" (P16) in Initial Setup for Wi-Fi settings.</li> </ul>
Wi-Fi Status	<p>The information for the connected access point is displayed.</p> <p>"SSID": The SSID of the connected access point          "Signal": The signal strength of the connected access point          "Status": The status of the connected access point</p>
MAC Address	<p>This is the MAC address of the AV receiver.          This value is specific to the component and cannot be changed.</p>
DHCP	<p>"Enable (default value)": Auto configuration by DHCP          "Disable": Manual configuration without DHCP          If "Disable" is selected, you must set "IP Address", "Subnet Mask", "Gateway", and "DNS Server" manually.</p>
IP Address	Displays/Sets the IP address.
Subnet Mask	Displays/Sets the subnet mask.
Gateway	Displays/Sets the gateway.
DNS Server	Displays/Sets the primary DNS server.
Proxy URL	Displays/Sets the proxy server URL.
Proxy Port	Displays/Sets the proxy server port number when you enter "Proxy URL".

## ■ 2. Network

- When LAN is configured with a DHCP, set "DHCP" to "Enable" to configure the setting automatically. Further, to assign fixed IP addresses to each component, you must set "DHCP" to "Disable" and assign an address to this unit in "IP Address" as well as set information related to your LAN, such as Subnet Mask and Gateway.

Wi-Fi	<p>Connect the unit to network via wireless LAN router.</p> <p>"On": Wireless LAN connection          "Off (Wired) (default value)": To connect via wired LAN</p>
-------	---



Friendly Name	<p>Change the device name for this unit which is shown on other devices connected to the network to an easily recognized name. This is set to Integra DTM-7 ***** at the time of purchase. (* stand for alphanumeric characters identifying each unit)</p> <ol style="list-style-type: none"> <li>1. Press Enter to display the Edit screen.</li> <li>2. Select a character or symbol with the cursors and press Enter. Repeat it to input 31 or less characters.           <ul style="list-style-type: none"> <li>"A/a": Switches between upper and lower cases. (Pressing Caps on the remote controller also toggles between upper and lower cases.)</li> <li>"←" "→": Moves the cursor to the arrow direction.</li> <li>"⊗": Removes a character on the left of the cursor.</li> <li>"␣": Enters a space.</li> </ul> <ul style="list-style-type: none"> <li>• Pressing CLR on the remote controller will remove all the input characters.</li> </ul> </li> <li>3. After inputting, select "OK" with the cursors and press Enter. The input name will be saved.</li> </ol>
AirPlay Password	<p>You can set a password of up to 31 characters so that only registered users can use AirPlay.</p> <ol style="list-style-type: none"> <li>1. Press Enter to display the Edit screen.</li> <li>2. Select a character or symbol with the cursors and press Enter. Repeat it to input 31 or less characters.           <ul style="list-style-type: none"> <li>"A/a": Switches between upper and lower cases. (Pressing Caps on the remote controller also toggles between upper and lower cases.)</li> <li>"←" "→": Moves the cursor to the arrow direction.</li> <li>"⊗": Removes a character on the left of the cursor.</li> <li>"␣": Enters a space.</li> </ul> <ul style="list-style-type: none"> <li>• To select whether to mask the password with "*" or display it in plain text, press Menu on the remote control.</li> <li>• Pressing CLR on the remote controller will remove all the input characters.</li> </ul> </li> <li>3. After inputting, select "OK" with the cursors and press Enter. The input password will be saved.</li> </ol>

Usage Data	<p>As a means of improving the quality of our products and services, we may collect information about your usage over the network. Select "Yes" if you agree to our collecting this information. Select "No" if you do not want us to collect this information. (Default Value is "No")</p> <p>You can set this after confirming the Privacy Policy. When you select "Usage Data" and press Enter, the Privacy Policy is displayed. (The same screen is displayed once also when setting up the network connection.) If you agree to the collection of the information, this setting also becomes "Yes". Note that if you agree to the Privacy Policy but select "No" for this setting, the information will not be collected.</p>
Network Check	<p>You can check the network connection. Press Enter when "Start" is displayed.</p>

- Wait for a while if "Network" cannot be selected. It will appear when the network feature is started.

### ■ 3. Bluetooth

Bluetooth	<p>Select whether or not to use the BLUETOOTH function.</p> <p>"On (default value)": Enables connection with a BLUETOOTH wireless technology enabled device by using the BLUETOOTH function. BLUETOOTH Select "On" also when making various BLUETOOTH settings.</p> <p>"Off": When the BLUETOOTH function is not to be used</p>
Auto Input Change	<p>The input of the unit will automatically be switched to "BLUETOOTH" when connection is made from a BLUETOOTH wireless technology enabled device to the unit.</p> <p>"On (default value)": The input will automatically become "BLUETOOTH" when a BLUETOOTH wireless technology enabled device is connected.</p> <p>"Off": The function is disabled.</p> <ul style="list-style-type: none"> <li>• If the input is not switched automatically, set to "Off" and change the input manually.</li> </ul>



Auto Reconnect	This function automatically reconnects to the BLUETOOTH wireless technology enabled device connected last when you change the input to "BLUETOOTH". "On (default value)": When this function is to be used "Off": When this function is not to be used <ul style="list-style-type: none"> <li>This may not work with some BLUETOOTH wireless technology enabled devices.</li> </ul>
Pairing Information	You can initialize the pairing information saved on this unit. Pressing Enter when "Clear" is displayed initializes the pairing information stored in this unit. <ul style="list-style-type: none"> <li>This function does not initialize the pairing information on the BLUETOOTH wireless technology enabled device. When pairing the unit again with the device, be sure to clear the pairing information on the BLUETOOTH wireless technology enabled device in advance. For information on how to clear the pairing information, refer to the BLUETOOTH wireless technology enabled device's instruction manual.</li> </ul>
Device	Displays the name of the BLUETOOTH wireless technology enabled device connected to the unit. <ul style="list-style-type: none"> <li>The name is not displayed when "Status" is "Ready" or "Pairing".</li> </ul>
Status	Displays the status of the BLUETOOTH wireless technology enabled device connected to the unit. "Ready": Not paired "Pairing": Pairing "Connected": Successfully connected

- Wait for a while if "Bluetooth" cannot be selected. It will appear when the BLUETOOTH function is started up.

#### ■ 4. Power Management

Sleep Timer	Allows the unit to enter standby automatically when the specified time elapses. Select "30 minutes", "60 minutes", or "90 minutes". "Off (default value)": Does not turn the unit to standby automatically.
-------------	--

Auto Standby	This setting places the unit on standby automatically after 20 minutes of inactivity without any video or audio input. (When "USB Power Out at Standby" or "Network Standby" is on, this becomes the Hybrid Standby mode which reduces the increase in power consumption to a minimum.) "On": The unit will automatically enter standby mode. "AUTO STBY" lights on the display. "Off (default value)": The unit will not automatically enter standby mode. <ul style="list-style-type: none"> <li>"Auto Standby" is displayed on the display and TV screen 30 seconds before the Auto Standby comes on.</li> <li>"Auto Standby" does not work when ZONE 2 is active.</li> </ul>
Auto Standby in HDMI Standby Through	Enable or disable "Auto Standby" while "HDMI Standby Through" is on. "On": Enable this function "Off": The setting will be disabled. <ul style="list-style-type: none"> <li>This setting cannot be set to "On" if "Auto Standby" and "HDMI" - "HDMI Standby Through" are set to "Off".</li> </ul>
USB Power Out at Standby	Devices connected to the USB port are supplied with electricity even when this unit is in standby mode when this function is "On". (Default Value is "Off") <ul style="list-style-type: none"> <li>When using this feature, power consumption increases even when this unit is on standby, however, the increase in power consumption is kept to a minimum by automatically entering the Hybrid Standby mode, where only essential circuits are operating.</li> </ul>



Network Standby	<p>When this feature is turned "On (default value)", you can turn on the power of the unit via the network using an application that can control this unit.</p> <ul style="list-style-type: none"> <li>When using "Network Standby", power consumption increases even when this unit is on standby, however, the increase in power consumption is kept to a minimum by automatically entering the Hybrid Standby mode, where only essential circuits are operating.</li> <li>When the connection to the network is lost, "Network Standby" is disabled to reduce power consumption. Use the power button on the remote controller or main unit to turn the unit on if this happens.</li> </ul>
Bluetooth Wakeup	<p>This function wakes up the unit on standby by connecting a BLUETOOTH wireless technology enabled device.</p> <p>"On": When this function is to be used          "Off (default value)": When this function is not to be used</p> <ul style="list-style-type: none"> <li>When this setting is turned "On", power consumption increases even when this unit is on standby, however, the increase in power consumption is kept to a minimum by automatically entering the Hybrid Standby mode, where only essential circuits are operating.</li> <li>The setting is fixed to "Off" if "5. Hardware" - "Bluetooth" - "Auto Input Change" is set to "Off".</li> </ul>

- Wait for a while if "Network Standby" or "Bluetooth Wakeup" cannot be selected. It will appear when the network feature is started.

### ■ 5. 12V Trigger A

Set when outputting the control signal (maximum 12 V/100 mA) through the 12V TRIGGER OUT A jack. Different settings can be set for each input selector. You can enable power link operation when you connect the unit and the external devices equipped with 12V trigger input jack.

Delay	<p>Set after how many seconds the 12V trigger output will occur in response to the unit's operation. As some devices cause a large current when they turn on, delay the output if such devices are connected.</p> <p>Select a value between "0sec (default value)" to "3sec".</p>
-------	---

BD/DVD	<p>Set the 12V trigger output setting to each input.</p> <p>"Off": No output          "Main (default value)": Output when "BD/DVD" is selected as input for main room.          "Zone 2": Output when "BD/DVD" is selected as input for ZONE 2.          "Main/Zone 2": Output when "BD/DVD" is selected as input for main room or ZONE 2.</p>
CBL/SAT	<p>Set the 12V trigger output setting to each input.</p> <p>"Off": No output          "Main (default value)": Output when "CBL/SAT" is selected as input for main room.          "Zone 2": Output when "CBL/SAT" is selected as input for ZONE 2.          "Main/Zone 2": Output when "CBL/SAT" is selected as input for main room or ZONE 2.</p>
GAME	<p>Set the 12V trigger output setting to each input.</p> <p>"Off": No output          "Main (default value)": Output when "GAME" is selected as input for main room.          "Zone 2": Output when "GAME" is selected as input for ZONE 2.          "Main/Zone 2": Output when "GAME" is selected as input for main room or ZONE 2.</p>
PC	<p>Set the 12V trigger output setting to each input.</p> <p>"Off": No output          "Main (default value)": Output when "PC" is selected as input for main room.          "Zone 2": Output when "PC" is selected as input for ZONE 2.          "Main/Zone 2": Output when "PC" is selected as input for main room or ZONE 2.</p>
CD	<p>Set the 12V trigger output setting to each input.</p> <p>"Off": No output          "Main (default value)": Output when "CD" is selected as input for main room.          "Zone 2": Output when "CD" is selected as input for ZONE 2.          "Main/Zone 2": Output when "CD" is selected as input for main room or ZONE 2.</p>





TV/TAPE	Set the 12V trigger output setting to each input. "Off": No output "Main (default value)": Output when "TV/TAPE" is selected as input for main room. "Zone 2": Output when "TV/TAPE" is selected as input for ZONE 2. "Main/Zone 2": Output when "TV/TAPE" is selected as input for main room or ZONE 2.
PHONO	Set the 12V trigger output setting to each input. "Off": No output "Main (default value)": Output when "PHONO" is selected as input for main room. "Zone 2": Output when "PHONO" is selected as input for ZONE 2. "Main/Zone 2": Output when "PHONO" is selected as input for main room or ZONE 2.
TUNER	Set the 12V trigger output setting to each input. "Off": No output "Main (default value)": Output when "TUNER" is selected as input for main room. "Zone 2": Output when "TUNER" is selected as input for ZONE 2. "Main/Zone 2": Output when "TUNER" is selected as input for main room or ZONE 2.
NET	Set the 12V trigger output setting to each input. "Off": No output "Main (default value)": Output when "NET" is selected as input for main room. "Zone 2": Output when "NET" is selected as input for ZONE 2. "Main/Zone 2": Output when "NET" is selected as input for main room or ZONE 2.

BLUETOOTH	Set the 12V trigger output setting to each input. "Off": No output "Main (default value)": Output when "BLUETOOTH" is selected as input for main room. "Zone 2": Output when "BLUETOOTH" is selected as input for ZONE 2. "Main/Zone 2": Output when "BLUETOOTH" is selected as input for main room or ZONE 2.
-----------	--

### ■ 6. 12V Trigger B

Set when outputting the control signal (maximum 12 V/25 mA) through the 12V TRIGGER OUT B jack. Different settings can be set for each input selector. You can enable power link operation when you connect the unit and the external devices equipped with 12V trigger input jack.

Delay	Set after how many seconds the 12V trigger output will occur in response to the unit's operation. As some devices cause a large current when they turn on, delay the output if such devices are connected. Select a value between "0sec" to "3sec". (Default Value is "1sec")
BD/DVD	Set the 12V trigger output setting to each input. "Off": No output "Main": Output when "BD/DVD" is selected as input for main room. "Zone 2 (default value)": Output when "BD/DVD" is selected as input for ZONE 2. "Main/Zone 2": Output when "BD/DVD" is selected as input for main room or ZONE 2.
CBL/SAT	Set the 12V trigger output setting to each input. "Off": No output "Main": Output when "CBL/SAT" is selected as input for main room. "Zone 2 (default value)": Output when "CBL/SAT" is selected as input for ZONE 2. "Main/Zone 2": Output when "CBL/SAT" is selected as input for main room or ZONE 2.



GAME	Set the 12V trigger output setting to each input. "Off": No output "Main": Output when "GAME" is selected as input for main room. "Zone 2 (default value)": Output when "GAME" is selected as input for ZONE 2. "Main/Zone 2": Output when "GAME" is selected as input for main room or ZONE 2.
PC	Set the 12V trigger output setting to each input. "Off": No output "Main": Output when "PC" is selected as input for main room. "Zone 2 (default value)": Output when "PC" is selected as input for ZONE 2. "Main/Zone 2": Output when "PC" is selected as input for main room or ZONE 2.
CD	Set the 12V trigger output setting to each input. "Off": No output "Main": Output when "CD" is selected as input for main room. "Zone 2 (default value)": Output when "CD" is selected as input for ZONE 2. "Main/Zone 2": Output when "CD" is selected as input for main room or ZONE 2.
TV/TAPE	Set the 12V trigger output setting to each input. "Off": No output "Main": Output when "TV/TAPE" is selected as input for main room. "Zone 2 (default value)": Output when "TV/TAPE" is selected as input for ZONE 2. "Main/Zone 2": Output when "TV/TAPE" is selected as input for main room or ZONE 2.
PHONO	Set the 12V trigger output setting to each input. "Off": No output "Main": Output when "PHONO" is selected as input for main room. "Zone 2 (default value)": Output when "PHONO" is selected as input for ZONE 2. "Main/Zone 2": Output when "PHONO" is selected as input for main room or ZONE 2.

TUNER	Set the 12V trigger output setting to each input. "Off": No output "Main": Output when "TUNER" is selected as input for main room. "Zone 2 (default value)": Output when "TUNER" is selected as input for ZONE 2. "Main/Zone 2": Output when "TUNER" is selected as input for main room or ZONE 2.
NET	Set the 12V trigger output setting to each input. "Off": No output "Main": Output when "NET" is selected as input for main room. "Zone 2 (default value)": Output when "NET" is selected as input for ZONE 2. "Main/Zone 2": Output when "NET" is selected as input for main room or ZONE 2.
BLUETOOTH	Set the 12V trigger output setting to each input. "Off": No output "Main": Output when "BLUETOOTH" is selected as input for main room. "Zone 2 (default value)": Output when "BLUETOOTH" is selected as input for ZONE 2. "Main/Zone 2": Output when "BLUETOOTH" is selected as input for main room or ZONE 2.



## 6. Multi Zone

### ■ 1. Remote Play Zone

Remote Play Zone	<p>When playing using AirPlay or Spotify Connect, or when using the Music Server feature to play remotely from your PC, you can set whether to play in the main room (where this unit is) or in a separate room (ZONE 2).</p> <p>"Auto (default value)": When the main room input selector is NET, music is played in the main room. When the separate room input selector is NET and the main room is other than NET, then the music is played in the separate room.</p> <p>"Main", "Zone 2": Select when limiting the play zone to a particular room. For example, when playing only in the separate room, select "Zone 2".</p> <ul style="list-style-type: none"> <li>• This feature may not work if something is already being played with the same network feature.</li> </ul>
------------------	---

## 7. Miscellaneous

### ■ 1. Tuner

AM / FM Frequency Step	<p>Select a frequency step depending on your area of residence. Select "10 kHz / 0.2 MHz (default value)" or "9 kHz / 0.05 MHz".</p> <ul style="list-style-type: none"> <li>• When this setting is changed, all radio presets are deleted.</li> </ul>
------------------------	---

### ■ 2. Firmware Update

Update Notice	<p>Availability of a firmware update will be notified via network.</p> <p>"Enable (default value)": Notify updates</p> <p>"Disable": Disable notifications</p>
Version	<p>The current firmware version will be displayed.</p>
Update via NET	<p>Press Enter to select when you want to update the firmware via network.</p> <ul style="list-style-type: none"> <li>• You will not be able to select this setting if you do not have Internet access or there is nothing to update.</li> </ul>

Update via USB	<p>Press Enter to select when you want to update the firmware via USB.</p> <ul style="list-style-type: none"> <li>• You will not be able to select this setting if a USB storage device is not connected or there is nothing to update in the USB storage device.</li> </ul>
----------------	--

- Wait for a while if "Firmware Update" cannot be selected. It will appear when the network feature is started.

### ■ 3. Initial Setup

You can make the Initial Setup from the Setup menu.

- Wait for a while if "Initial Setup" cannot be selected. It will appear when the network feature is started.

### ■ 4. Lock

Setup Parameter	<p>Lock the Setup menu to protect the settings.</p> <p>"Locked": The menu is locked.</p> <p>"Unlocked (default value)": Unlocked</p>
-----------------	--



## AUDIO Menu

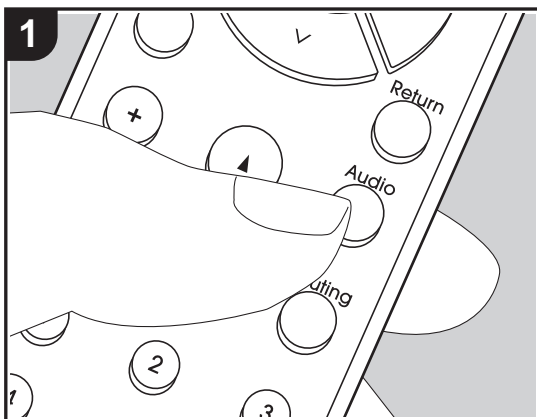

By pressing the Audio button on the remote controller during play, you can adjust frequently used settings, such as the sound quality, using on-screen menus.

1. Press Audio on the remote controller to display the AUDIO menu.

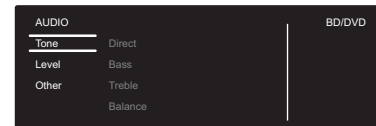

2. Select the item with  $\wedge$  /  $\vee$  on the remote controller and press Enter to confirm your selection.

- Change the initial values for each of the settings with the cursors  $<$  /  $>$ .
  - To return to the previous screen, press Return.
3. To exit the settings, press Audio.

### ■ Tone

**Direct:** Enable or disable the Direct feature which outputs pure sound as it was intended by bypassing the tone control circuits during play.

**Bass:** Enhance or moderate the bass range of the front speakers.

- It cannot be set if the Direct mode is selected.

**Treble:** Enhance or moderate the treble range of the front speakers.

- It cannot be set if the Direct mode is selected.

**Balance:** Adjust the balance of the sounds output from the left and right speakers.

### ■ Level

**Subwoofer:** Adjust the speaker level of the subwoofer while listening to some sound.

- The adjustment you made will be reset to the previous status when you turn the unit to standby mode.

### ■ Other

**A/V Sync:** If the video is behind the audio, you can delay the audio to offset the gap. Different settings can be set for each input selector.

**Music Optimizer:** Improve the quality of the compressed audio. Playback sound of lossy compressed files such as MP3 will be improved. The setting can be separately set to each input selector. The setting is effective in the signals of 48 kHz or less. The setting is not



effective in the bitstream signals.

- It cannot be set if the Direct mode is selected.



## Web Setup

You can make the settings for network features for this unit in an internet browser on a PC, smartphone, etc.

1. Press Setup on the remote controller to display the Setup menu.
2. Select "5. Hardware" - "Network" with the cursors, then take a note of the IP address displayed in "IP Address".
3. Start the internet browser on your PC or smartphone and enter the IP address of the unit in the URL field.
4. Information for the unit (Web Setup screen) is displayed in the internet browser.

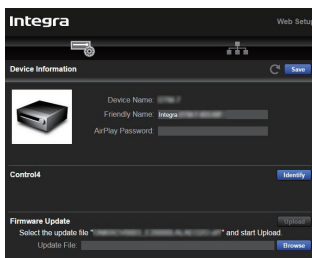

5. After changing the settings, select "Save" to save the settings.

### Device Information

You can change the Friendly Name, set an AirPlay Password, etc.

Control4: Register this unit if you are using a Control4 system.

Firmware Update: Select the firmware update you have downloaded to your PC so you can update this unit.

### Network Setting

Status: You can see information for the network such as the MAC address and IP address for this unit.

Network Connection: You can select how to connect to the network. If you select "Wireless", select an access point from "Wi-Fi Setup" to connect.

DHCP: You can change DHCP settings. If you select "Off", set "IP Address", "Subnet Mask", "Gateway", and "DNS Server" manually.

Proxy: Display and set the URL for the proxy server.



# Firmware Update

## The updating function on this unit

This unit has functionality to update the firmware (the system software) over a network or by the USB port. This enables us to make improvements to a variety of operations and to add features.

## How to update

There are two methods for updating the firmware: via network and via USB. The update may take about 20 minutes to complete for either method: via network or via USB. Furthermore, settings you have changed are maintained regardless of the method used for update. Note that when this unit is connected to a network, you may see notifications about firmware updates on the display. To execute updating, select "Update Now" with the cursors of the remote controller and press Enter. "Completed!" is displayed when the update is complete.

- For the latest information on updates, visit our website. There is no need to update the firmware on this unit if there is no update available.
- During an update, do not:
  - Disconnect and reconnect any cable or USB storage device, headphones, or perform any operation on the component such as turn off its power
  - Accessing this unit from a PC or smartphone using an application

**Disclaimer:** The program and accompanying online documentation are furnished to you for use at your own risk.

We will not be liable and you will have no remedy for damages for any claim of any kind whatsoever concerning your use of the program or the accompanying online documentation, regardless of legal theory, and whether arising in tort or contract.

In no event will we be liable to you or any third party for any special, indirect, incidental, or consequential damages of any kind, including, but not limited to, compensation, reimbursement or damages on account of the loss of present or prospective profits, loss of data, or for any other reason whatsoever.

## Updating the Firmware via Network

- Check that the unit is turned on, and the connection to the Internet is secured.
  - Turn off the controller component (PC etc.) connected to the network.
  - Stop any playing Internet radio, USB storage device, or server content.
  - If the multi-zone function is active, turn it off.
  - When "5. Hardware" - "HDMI" - "HDMI CEC" is set to "On" in the Setup menu, set to "Off".
  - The description may differ from the on-screen display but that will not change operations or functionality.
1. Switch the input on the TV to that assigned to the unit.
  2. Press Setup on the remote controller.

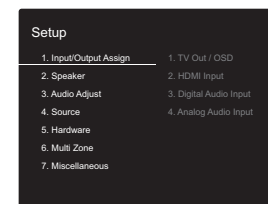

3. Select "7. Miscellaneous" - "Firmware Update" - "Update via NET" with the cursors in order and press Enter.

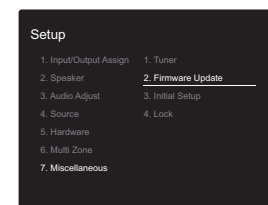

- If "Firmware Update" is grayed out and cannot be selected, wait for a while until it starts up.
- You will not be able to select "Update via NET" if there is no firmware update.



4. Press Enter with "Update" selected to start update.
  - During the update, the TV screen may go black depending on the updated program. In that case, check the progress on the display of the unit. The TV screen will remain black until the update is complete and the power is turned on again.
  - "Completed!" is displayed when the update is complete.
5. Press On/Standby on the main unit to switch the unit to standby. The process is completed and your firmware is updated to the latest version.
  - Do not use on the remote controller.

**If an Error Message is Displayed:** When an error occurs, "\*-\*-\* Error!" is displayed on the display of the unit. ("\*" represents an alphanumeric character.) Check the following:

- \*-01, \*-10: Cannot recognize Ethernet cable. Connect the Ethernet cable properly.
- \*-02, \*-03, \*-04, \*-05, \*-06, \*-11, \*-13, \*-14, \*-16, \*-17, \*-18, \*-20, \*-21: Internet connection error. Check the following:
  - Whether the router is turned on
  - Whether this unit and router are connected to the network
 Try to disconnect and then connect again the power to the unit and router. This may solve the problem. If you are still unable to connect to the Internet, the DNS server or proxy server may be temporarily down. Check the service status with your ISP provider.
- **Others:** Disconnect then reconnect the power cord, then repeat from the beginning.

### Updating via USB

- Prepare a 128MB or larger USB storage device. FAT16 or FAT32 file system format.
  - Media inserted in a USB card reader may not be used for this function.

- USB storage devices with security function are not supported.
  - USB hubs and USB devices with hub function are not supported. Do not connect these devices to the unit.
- Delete any data stored on the USB storage device.
  - Turn off the controller component (PC etc.) connected to the network.
  - Stop any playing Internet radio, USB storage device, or server content.
  - If the multi-zone function is active, turn it off.
  - When "5. Hardware" - "HDMI" - "HDMI CEC" is set to "On" in the Setup menu, set to "Off".
  - Some USB storage devices may take long to load, may not be loaded correctly, or may not be correctly fed depending on the device or their content.
  - We will not be liable whatsoever for any loss or damage of data, or storage failure arising from the use of the USB storage device with this AV receiver. Thank you for your understanding.
  - The description may differ from the on-screen display but that will not change the way to operate or the function.
    1. Connect the USB storage device to your PC.
    2. Download the firmware file from the our website to your PC and unzip.
      - Firmware files are named in the following way:  
ONKRCV\*\*\*\*\*\_\*\*\*\*\*.zip
      - Unzip the file on your PC. The number of unzipped files and folders varies depending on the model.
    3. Copy all unzipped files and folders to the root folder of the USB storage device.
      - Make sure to copy the unzipped files.
    4. Connect the USB storage device to the USB port on the main unit.
      - If you connect a USB hard disk drive to the USB port of the unit, we recommend that you use its AC adapter to power it.
      - If the USB storage device has been partitioned, each section will be treated as an independent device.
    5. Switch the input on the TV to that assigned to the unit.

6. Press Setup on the remote controller.

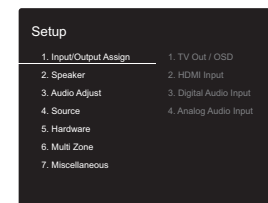

7. Select "7. Miscellaneous" - "Firmware Update" - "Update via USB" with the cursors in order and press Enter.

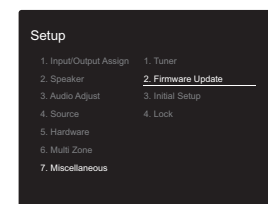

- If "Firmware Update" is grayed out and cannot be selected, wait for a while until it starts up.
  - You will not be able to select "Update via USB" if there is no firmware update.
8. Press Enter with "Update" selected to start update.
    - During the update, the TV screen may go black depending on the updated program. In that case, check the progress on the display of the unit. The TV screen will remain black until the update is complete and the power is turned on again.
    - During the update, do not turn off, or disconnect then reconnect the USB storage device.
    - "Completed!" is displayed when the update is complete.
  9. Disconnect the USB storage device from the main unit.
  10. Press On/Standby on the main unit to switch the unit to standby. The process is completed and your firmware is updated to the latest version.





- Do not use  on the remote controller.

**If an Error Message is Displayed:** When an error occurs, "\*-\*-\* Error!" is displayed on the display of the unit. ("\*" represents an alphanumeric character.) Check the following:

- **\*-01, \*-10:** USB storage device not found. Check whether the USB storage device or USB cable is correctly inserted to the USB port of this unit. Connect the USB storage device to an external power source if it has its own power supply.
- **\*-05, \*-13, \*-20, \*-21:** The firmware file is not present in the root folder of the USB storage device, or the firmware file is for another model. Retry from the download of the firmware file.
- **Others:** Disconnect then reconnect the power cord, then repeat from the beginning.



## Supplementary Information

Due to firmware (the software for the system) updates after you make your purchase or firmware changes during production of the product, there may be additions or changes to the settings and operation available compared to what is in the instruction manual.

For information about the settings and operations that have been added or changed, see the following references. Refer to "Supplementary information for player functions" (P30) for information about changes to player functions.

[Supplementary Information](#)

>>> [Click here](#) <<<





# Troubleshooting

## Before starting the procedure

Problems may be solved by simply turning the power on/off or disconnecting/connecting the power cord, which is easier than working on the connection, setting and operating procedure. Try the simple measures on both the unit and the connected device. If the problem is that the video or audio is not output or the HDMI linked operation does not work, disconnecting/connecting the HDMI cable may solve it. Turn off the device connected to this unit, then disconnect and reconnect the cable. When reconnecting, be careful not to wind the HDMI cable since if wound the HDMI cable may not fit well.

- The AV receiver contains a microPC for signal processing and control functions. In very rare situations, severe interference, noise from an external source, or static electricity may cause it to lockup. In the unlikely event that this happens, unplug the power cord from the wall outlet, wait at least 5 seconds, and then plug it back in.
- We are not responsible for reparations for damages (such as CD rental fees) due to unsuccessful recordings caused by the unit's malfunction. Before you record important data, make sure that the material will be recorded correctly.

## If operation becomes unstable

### Try restarting the unit

The issue may be fixed by restarting this unit. After switching this unit to standby, press and hold  On/Standby on this unit for 5 or more seconds to restart the unit.

(The settings in the unit are maintained.) If the issue is not fixed by restarting, try unplugging the power cords of the unit and connected devices, and then plugging them in again.

### Resetting the unit (this resets the unit settings to the default)

If restarting the unit doesn't fix the problem, resetting the unit to the status at the time of shipment may solve the problem. Your settings will also be initialized when you reset, so note down your settings before doing the following.

1. While holding down Tuning Mode on the main unit, press  On/Standby.
2. The unit switches to standby and the settings are reset.

## ■ Power

### Cannot turn on the unit

- Make sure that the power cord is properly plugged into the wall outlet.
- Unplug the power cord from the wall outlet, wait 5 seconds or more, then plug it in again.

### The unit turns off unexpectedly

- The unit automatically switches to standby when the "5. Hardware" - "Power Management" - "Auto Standby" setting in the Setup menu functions.
- The protective circuit function may have been activated. If this has occurred, "AMP Diag Mode" appears on the display when the unit is turned on again, and the unit enters diagnostic mode. If the results of the diagnosis is that there is no problem, the "AMP Diag Mode" display disappears and you can use the unit normally again. If "CHECK SP WIRE" appears on the display, the speaker cables may be short-circuited. Make sure bare speaker wires are not touching each other or the back panel of the unit, then turn the unit on again. If "NG" is displayed, immediately unplug the power cord from the wall outlet and contact your dealer.
- The protective circuit function may have been activated because the temperature of the unit rose abnormally. If this happens, then the power will continue to turn off after you have turned the unit on again. Make sure the unit has plenty of space for ventilation around it, wait for the unit to cool down sufficiently, and then try turning it on again.

**WARNING:** If smoke, smell or abnormal noise is produced by the unit, unplug the power cord from the wall outlet immediately and contact the dealer or customer support.

## ■ Audio

- Confirm that the connection between the output jack on the device and the input jack on this unit is correct.



- Make sure that none of the connecting cables are bent, twisted, or damaged.
- If the MUTE indicator on the display flashes, press Muting on the remote controller to cancel muting.
- While headphones are connected to the Phones jack, no sound is output from the speakers.

Check the following if the above does not fix the problem:

#### There is no sound from the TV

- Change the input selector on this unit to the position of the terminal to which the TV is connected.
- When connected to a TV that supports the ARC feature with an HDMI cable, only PCM audio input is supported from the TV to this unit. Make sure that your TV audio output setting is set to PCM.
- If the TV doesn't support the ARC function, along with connection by HDMI, connect the TV and this unit using a digital optical cable, digital coaxial cable, or analog audio cable.

#### No sound from a connected player

- Change the input selector on this unit to the position of the terminal to which the player is connected.
- Check the digital audio output setting on the connected component. On some game consoles, such as those that support DVD, the default setting is off.
- With some DVD-Video discs, you need to select an audio output format from a menu.

#### A speaker produces no sound

- Make sure that the polarity of the speaker cables (+/-) is correct, and that no bare wires are in contact with the metal part of speaker terminals.
- Make sure that the speaker cables have not shorted.
- Make sure the speakers are connected correctly (P10).

#### The subwoofer produces no sound

If the setting of the front speakers is "Full Band" and during 2ch input such as from the TV or music, the low range elements will be output from the front speakers rather than

from the subwoofer. If you would rather output from the subwoofer, make one of the following settings.

1. Change the front speakers settings to a setting other than "Full Band" for the crossover frequency value.  
The range below the frequency you specify will be output from the subwoofer rather than the front speakers. We do not recommend changing this if your front speakers have good low range reproduction capabilities.
  2. Change "Double Bass" to "On".  
The low range elements will be output from both the front speakers and the subwoofer. This may mean that there is too much bass. Do not change if this happens, or choose option 1.
- Refer to "2. Speaker" - "Crossover" (P33) in the Setup menu for details.
  - When you play source material that contains no information in the LFE channel, the subwoofer produces no sound.

#### Noise can be heard

- Using cable ties to bundle analog audio cables, power cords, speaker cables, etc. may degrade the audio performance. Do not bundle cords.
- An audio cable may be picking up interference. Try repositioning your cables.

#### The beginning of audio received by an HDMI IN cannot be heard

- Since it takes longer to identify the format of an HDMI signal than it does for other digital audio signals, audio output may not start immediately.

#### Sound suddenly reduces

- When the temperature inside the unit exceeds a certain temperature for extended periods, the volume may be reduced automatically to protect the circuits.

#### ■ Video

- Confirm that the connection between the output jack on

the device and the input jack on this unit is correct.

- Make sure that none of the connecting cables are bent, twisted, or damaged.
- There may be interference from the power cords or other connection cables to this unit if the picture on the TV is poor. Try separating the TV antenna cable and other cables of the unit.
- Check the screen input on the monitor, such as the TV.

Check the following if the above does not fix the problem:

#### There is no video

- Change the input selector on this unit to the position of the terminal to which the player is connected.

#### There is no picture from a source connected to an HDMI IN terminal

- To display video from the connected player on the TV screen while the unit is in standby, you need to enable "5. Hardware" - "HDMI" - "HDMI Standby Through" in the Setup menu. Refer to (P36) for information about HDMI Standby Through.
- Check if "Resolution Error" is displayed on the main unit display when video input via HDMI IN jack is not displayed. In this case, the TV does not support the resolution of the video input from the player. Change the setting on the player.
- Reliable operation with an HDMI-to-DVI adapter is not guaranteed. In addition, video signals from a PC are not supported.

#### Images flicker

- It is possible that the resolution of the player is not compatible with the TV's resolution. If you have connected the player to this unit with an HDMI cable, try changing the output resolution on the player. There also may be an improvement if you change the screen mode on the TV.

#### Video and audio are out of sync

- Video may be delayed relative to audio depending on the



settings and connections with your TV. To adjust, press Audio on the remote controller, and adjust in "Other" - "A/V Sync".

### ■ Linked operation

**There is no linked operation with CEC compliant devices, such as a TV.**

- The "5. Hardware" - "HDMI" - "HDMI CEC" setting in the Setup menu needs to be set to "On".
- It is also necessary to set HDMI linking on the CEC compliant device. Check the instruction manual.

### ■ AM/FM broadcasting

**Radio reception is poor or there is a lot of noise.**

- Re-check the antenna connection.
- Separate the antenna from speaker cables and the power cord.
- Move the unit away from your TV or PC.
- Passing cars and airplanes can cause interference.
- Concrete walls weaken radio signals.
- Listen to the station in mono.
- When listening to an AM station, operating the remote controller may cause noise.
- FM reception may become clearer if you use the antenna jack on the wall used for the TV.

### ■ The BLUETOOTH feature

- Try plugging/unplugging the power of the unit and try turning on/off the BLUETOOTH wireless technology enabled device. Restarting the BLUETOOTH wireless technology enabled device may be effective.
- The BLUETOOTH wireless technology enabled devices must support the A2DP profile.
- Radio wave interference may occur in the vicinity of components, such as microwave ovens or cordless

phones, which use radio waves in the 2.4 GHz range. This interference may render this unit unusable.

- If there is a metallic object near the unit, BLUETOOTH connection may not be possible as the metal can effect on the radio waves.

Check the following if the above does not fix the problem:

#### Cannot connect with this unit

- Check that the BLUETOOTH function of the BLUETOOTH wireless technology enabled device is enabled.

#### Music playback is unavailable on the unit even after successful BLUETOOTH connection

- When the audio volume of your BLUETOOTH wireless technology enabled device is set low, the playback of audio may be unavailable. Turn up the volume on the BLUETOOTH wireless technology enabled device.
- Some BLUETOOTH wireless technology enabled devices may be equipped with a Send/Receive selector switch. Select Send mode.
- Depending on the characteristics or specifications of your BLUETOOTH wireless technology enabled device, playback on this unit may not be possible.

#### Sound is interrupted

- There may be a problem with the BLUETOOTH wireless technology enabled device. Check the information on the internet.

#### The audio quality is poor after connection with a BLUETOOTH wireless technology enabled device

- Reception is poor. Move the BLUETOOTH wireless technology enabled device closer to the unit or remove any obstacle between the BLUETOOTH wireless technology enabled device and this unit.

### ■ Network Functions

- If you cannot select a network service, it will become selectable when the network function is started. It may take about a minute to start up.
- When NET is blinking, the AV receiver is not properly connected to the home network.
- Try plugging/unplugging the power supply of this unit and the router, and try rebooting the router.
- If the desired wireless LAN router is not in the access point list, it may be set to hide SSID or the ANY connection may be off. Change the setting and try again.

Check the following if the above does not fix the problem:

#### Cannot access the Internet radio

- Certain network service or contents available through the unit may not be accessible in case the service provider terminates its service.
- Make sure that your modem and router are properly connected, and make sure they are both turned on.
- Make sure that the LAN side port on the router is properly connected to the AV receiver.
- Make sure that connecting to Internet from other components is possible. If connecting is not possible, turn off all components connected to the network, wait for a while, and then turn on the components again.
- If a specific radio station is unavailable for listening, make sure the registered URL is correct, or whether the format distributed from the radio station is supported by the AV receiver.
- Depending on ISP, setting the proxy server is necessary.
- Make sure that the router and/or modem you are using is supported by your ISP.

#### Cannot access the network server

- This unit needs to be connected to the same router as the network server.
- This unit is compatible with Windows Media® Player 11 or 12 network servers or NAS that are compatible with



home network functionality.

- You may need to make some settings on Windows Media® Player (P27).
- When using a PC, only music files registered in the Windows Media® Player library can be played.

#### **Playback stops while listening to music files on the network server**

- Make sure the network server is compatible with this unit.
- When the PC is serving as the network server, try quitting any application software other than the server software (Windows Media® Player 12 etc.).
- If the PC is downloading or copying large files, the playback may be interrupted.

#### **■ USB storage device**

##### **USB storage device is not displayed**

- Check whether the USB storage device or USB cable is correctly inserted to the USB port of the unit.
- Disconnect the USB storage device from the unit, and then try reconnecting.
- Performance of hard disks that receive power from the USB port of the unit is not guaranteed.
- Depending on the type of format, the playback may not be performed normally. Check the type of the file formats that is supported.
- USB storage devices with security functions may not be played.

#### **■ Wireless LAN Network**

- Try plugging/unplugging the power supply of wireless LAN router and the unit, check the wireless LAN router power-on status, and try reboot of the wireless LAN router.

Check the following if the above does not fix the problem:

#### **Cannot access wireless LAN network**

- The wireless LAN router setting may be switched to Manual. Return the setting to Auto.
- Try the manual set-up. The connection may succeed.
- When the wireless LAN router setting is at stealth mode (mode to hide the SSID key) or when ANY connection is off, the SSID is not displayed. Change the setting and try again.
- Check that the setting of SSID and encryption (WEP, etc.) is correct. Make sure the network settings of the unit is properly set.
- Connection to an SSID that includes multi-byte characters is not supported. Name the SSID of the wireless LAN router using single-byte alphanumeric characters only and try again.

#### **Connected to an SSID different to the SSID selected**

- Some wireless LAN routers allow you to set multiple SSIDs for one unit. If you use the automatic setting button on such a router, you may end up connecting with a different SSID from the SSID you wanted to connect to. Use the connection method requiring you to enter a password if this happens.

#### **Playback is interrupted and communication does not work**

- You may not receive radio waves due to bad radio wave conditions. Shorten the distance from the wireless LAN router or remove obstacles to improve visibility, and try again. Place the unit away from microwave ovens or other access points. It is recommended to place the wireless LAN router and the unit in the same room.
- If there is a metallic object near the unit, wireless LAN connection may not be possible as the metal can effect on the radio wave.
- When other wireless LAN devices are used near the unit, several issues such as interrupted playback and communication may occur. You can avoid these issues by changing the channel of your wireless LAN router. For instructions on changing channels, see the instruction

manual provided with your wireless LAN router.

- There may not be enough bandwidth available in the band for wireless LAN. Connect using an Ethernet cable.

#### **■ Multi Zone feature**

- Settings are required in Initial Setup, "3. Multi Zone Setup" to use the multi-zone feature (P17).
- DSD audio signals are not output to ZONE 2 with the "NET" input selector.

Check the following if the above does not fix the problem:

#### **Cannot ZONE output audio of external AV component**

- When outputting the audio of an external AV component to ZONE 2, connect using an analog audio cable.

#### **■ Remote Controller**

- Make sure that the batteries are installed with the correct polarity.
- Install new batteries. Do not mix different types of batteries, or old and new batteries.
- Make sure that the unit is not subjected to direct sunshine or inverter-type fluorescent lights. Relocate if necessary.
- If the unit is installed in a rack or cabinet with colored-glass doors or if the doors are closed, the remote controller may not work reliably.
- After operating the Multi-zone function, the remote controller may have switched to the mode for controlling ZONE 2. Press Remote Mode Main to switch to the mode to control the main room.

#### **■ Display**

##### **The display doesn't light**

- The display may go dim while the Dimmer is working. Press Dimmer to change the brightness level of the



display.

## ■ **Others**

### **Strange noises can be heard from the unit**

- If you have connected another unit to the same wall outlet as this unit, this noise may be an effect from the other unit. If the symptoms improve by unplugging the power cord of the other unit, use different wall outlets for this unit and the other unit.



# General Specifications

## Amplifier (Audio) section

### Rated Output Power (FTC)

With 8 ohm loads, both channels driven, from 20-20,000 Hz; rated 100 watts per channel minimum RMS power, with no more than 0.08% total harmonic distortion from 250 milliwatts to rated output.

### Maximum Effective Output Power

2 ch × 170 W at 6 ohms, 1 kHz, 2 ch driven of 10% THD

### Dynamic Power (\*)

(\*)IEC60268-Short-term maximum output power

240 W (3 Ω, Front)

210 W (4 Ω, Front)

120 W (8 Ω, Front)

### THD+N (Total Harmonic Distortion+Noise)

0.08% (20 Hz - 20,000 Hz, half power)

### Input Sensitivity and Impedance (1 kHz, 100 W/8 Ω)

200 mV/47 kΩ (LINE (Unbalance))

3.5 mV/47 kΩ (PHONO MM)

### Rated RCA Output Level and Impedance

1 V/470 Ω (SUBWOOFER PRE OUT)

200 mV/2.3 kΩ (ZONE LINE OUT)

### Phono Overload

70 mV (MM 1 kHz, 0.5%)

### Frequency Response

10 Hz - 100 kHz/+1 dB, -3 dB (Direct)

### Tone Control Characteristics

±10 dB, 90 Hz (Bass)

±10 dB, 7.5 kHz (Treble)

### Signal to Noise Ratio

106 dB (IHF-A, LINE IN, SP OUT)

80 dB (IHF-A, PHONO IN, SP OUT)

### Speaker Impedance

4 Ω - 16 Ω

### Headphone Output Impedance

330 Ω

### Headphone Rated Output

80 mW (32 Ω, 1 kHz, 10% THD)

## Tuner Section

### FM Tuning Frequency Range

87.5 MHz - 107.9 MHz

### AM Tuning Frequency Range

530 kHz - 1710 kHz

### Preset Channel

40

## Network Section

### Ethernet LAN

10BASE-T/100BASE-TX

### Wireless LAN

IEEE 802.11 a/b/g/n standard

(Wi-Fi® standard)

5 GHz/2.4 GHz band

## BLUETOOTH Section

### Communication system

BLUETOOTH Specification version 4.1+LE

### Frequency band

2.4 GHz band

### Modulation method

FHSS (Frequency Hopping Spread Spectrum)

### Compatible BLUETOOTH profiles

A2DP 1.2

AVRCP 1.3

HOGP-Host (Client)

HOGP-HID Device (Server)

HID Service (HIDS)

### Supported Codecs

SBC

AAC

### Transmission range (A2DP)

20 Hz - 20 kHz (Sampling frequency 44.1 kHz)

### Maximum communication range

Line of sight approx. 48 ft. (15 m) (\*)

(\*)The actual range will vary depending on factors such as obstacles between devices, magnetic fields around a microwave oven, static electricity, cordless phone,

reception sensitivity, antenna's performance, operating system, software application, etc.

## General

### Power Supply

AC 120 V, 60 Hz

### Power Consumption

260 W

0.1 W (Stand-by)

35 W (No-sound)

4.2 W (HDMI Standby Through)

2.6 W (Network Standby)

### Dimensions (W × H × D)

17-1/8" × 5-7/8" × 12-15/16"

435 mm × 149.5 mm × 328.5 mm

### Weight

18.7 lbs/8.5 kg

## HDMI

### Input

IN1 (BD/DVD), IN2 (CBL/SAT), IN3 (PC), IN4 (GAME)

### Output

OUT

### Supported

Deep Color, x.v.Color™, LipSync, Audio Return Channel, 3D, 4K 60Hz, CEC, Extended Colorimetry (sYCC601, Adobe RGB, Adobe YCC601), Content Type, HDR

### Audio Format

DSD, PCM

### Maximum Video Resolution

4k 60 Hz (YCbCr 4:4:4)

## Compatible input resolutions

### HDMI input

4K, 1080p/24, 1080p, 1080i, 720p, 480p/576p

### Composite input

480i/576i

- The output from the HDMI OUT jack to the TV is the same resolution as the input.





## Audio Inputs

### Digital

OPTICAL IN1 (GAME), IN2 (TV/TAPE)  
COAXIAL IN (CD)

### Analog

IN1 (PC), IN2 (TV/TAPE), IN3 (CD), PHONO

## Audio Outputs

### Analog

ZONE2 LINE OUT  
2 SUBWOOFER PRE OUT

### Speaker Outputs

SPEAKERS A: FRONT L/R  
SPEAKERS B: FRONT L/R  
(Compatible with banana plugs)

### Phones

Phones (Front,  $\varnothing 1/4''/6.3$  mm)

## Others

USB: 2 (Front: Ver.2.0, 5 V/1 A, Rear: Ver.2.0, 5 V/  
500 mA)

Ethernet: 1

RI REMOTE CONTROL: 1

RS232: 1

12V TRIGGER OUT: 2 (A: 100 mA, B: 25 mA)

IR IN: 1

IR OUT: 1

## Power consumption in standby mode

In the following cases, the power consumption in standby mode may reach up to a maximum of 15 W:

- When "Network Standby" is set to "On"
- When "HDMI CEC" is set to "On"
- When "HDMI Standby Through" is set to other than "Off"
- When "Bluetooth Wakeup" is set to "On"
- When "USB Power Out at Standby" is set to "On"



# Reference Information

## About HDMI

### Compatible functions

HDMI (High Definition Multimedia Interface) is a digital interface standard for connecting TVs, projectors, Blu-ray Disc/DVD players, set-top boxes, and other video components. Until now, several separate video and audio cables have been required to connect AV components. With HDMI, a single cable can carry control signals, digital video, and digital audio (2-channel PCM and multichannel digital audio).

**The HDMI CEC feature:** By connecting devices and HDMI cables that comply with the CEC (Consumer Electronics Control) specification of the HDMI standard, a variety of linked operation become possible between devices. You can enjoy features such as linking input switching with input and players, control volume using the remote controller of the TV, and automatically switching this unit to standby when the TV is turned off. The unit is designed to link with products that comply with the CEC standard, and that linked operation is not always guaranteed with all CEC devices.

**ARC (Audio Return Channel):** By connecting a TV that supports ARC with a single HDMI cable, you can not only output the audio and video from this unit to the TV, but also input the audio from the TV to this unit.

**HDMI Standby Through:** Even if this unit is in standby, the input signals from AV components are transmitted to the TV.

**Deep Color:** By connecting devices supporting Deep Color, video signals input from the devices can be reproduced on the TV with even more colors.

**x.v.Color™:** This technology realizes even more realistic colors by broadening the color gamut.

**3D:** You can transmit 3D video signals from AV components to the TV.

**4K:** This unit supports 4K (3840×2160p) and 4K SMPTE (4096×2160p) video signals.

**LipSync:** This setting automatically corrects any desynchronization between the video and audio signals based on data from the HDMI Lip-Sync compatible TV.

### Supported Audio Formats

**2-channel linear PCM:** 32 kHz, 44.1 kHz, 48 kHz, 88.2 kHz, 96 kHz, 176.4 kHz, 192 kHz, 16/20/24 bit

**DSD:** Supported sampling rates: 2.8 MHz  
Your Blu-ray Disc/DVD player must also support HDMI output of the above audio formats.

### Supported resolutions

**Copyright protection technology:** HDCP1.4/HDCP2.2

**Color Depth:** 720×480i 60Hz, 720×576i 50Hz, 720×480p 60Hz, 720×576p 50Hz, 1920×1080i 50/60Hz, 1280×720p 24/25/30/50/60Hz, 1680×720p 24/25/30/50/60Hz, 1920×1080p 24/25/30/50/60Hz, 2560×1080p 24/25/30/50/60Hz, 4K (3840×2160p) 24/25/30Hz, 4K SMPTE (4096×2160p) 24/25/30Hz : RGB/YCbCr4:4:4 (8/10/12 bit), YCbCr4:2:2 (12 bit)  
4K (3840×2160p) 50/60Hz, 4K SMPTE (4096×2160p) 50/60Hz : RGB/YCbCr4:4:4 (8 bit), YCbCr4:2:2 (12 bit), YCbCr4:2:0 (8/10/12 bit)

### Supported Audio Formats

#### USB Storage

This unit supports the following music file formats. Note that sound files that are protected by copyright cannot be played on this unit.

#### MP3 (.mp3/.MP3):

- Supported formats: MPEG-1/MPEG-2 Audio Layer 3
- Supported sampling rates: 44.1 kHz, 48 kHz
- Supported bitrates: Between 8 kbps and 320 kbps and VBR

#### WMA (.wma/.WMA):

- Supported sampling rates: 44.1 kHz and 48 kHz
- Supported bitrates: Between 5 kbps and 320 kbps and VBR
- WMA Pro/Voice/WMA Lossless formats are not supported

#### WAV (.wav/.WAV):

- WAV files include uncompressed PCM digital audio.
- Supported sampling rates: 44.1 kHz, 48 kHz, 88.2 kHz, 96 kHz, 176.4 kHz, 192 kHz
  - Quantization bit: 8 bit, 16 bit, 24 bit

#### AIFF (.aiff/.aif/.AIFF/.AIF):

- AIFF files include uncompressed PCM digital audio.
- Supported sampling rates: 44.1 kHz, 48 kHz, 88.2 kHz, 96 kHz, 176.4 kHz, 192 kHz
  - Quantization bit: 8 bit, 16 bit, 24 bit

#### AAC (.aac/.m4a/.mp4/.3gp/.3g2/.AAC/.M4A/.MP4/.3GP/.3G2):

- Supported formats: MPEG-2/MPEG-4 Audio
- Supported sampling rates: 44.1 kHz, 48 kHz, 88.2 kHz, 96 kHz
- Supported bitrates: Between 8 kbps and 320 kbps and VBR

#### FLAC (.flac/.FLAC):

- Supported sampling rates: 44.1 kHz, 48 kHz, 88.2 kHz, 96 kHz, 176.4 kHz, 192 kHz
- Quantization bit: 8 bit, 16 bit, 24 bit

#### Apple Lossless (.m4a/.mp4/.M4A/.MP4):

- Supported sampling rates: 44.1 kHz, 48 kHz, 88.2 kHz,



- 96 kHz, 176.4 kHz, 192 kHz
- Quantization bit: 16 bit, 24 bit

#### **DSD (.dsf/.dff/.DSF/.DFF):**

- Supported formats: DSF/DSDIFF
- Supported sampling rates: 2.8 MHz and 5.6 MHz
- Variable bit-rate (VBR) files are supported. However, playback times may not be displayed correctly.
- This unit supports the gapless playback of the USB storage device in the following conditions.  
When playing WAV, FLAC and Apple Lossless, and the same format, sampling frequency, channels and quantization bit rate are played continuously

#### **Music Server**

This unit supports the following music file formats. Remote play of FLAC and DSD is not supported.

#### **MP3 (.mp3/.MP3):**

- Supported formats: MPEG-1/MPEG-2 Audio Layer 3
- Supported sampling rates: 44.1 kHz, 48 kHz
- Supported bitrates: Between 8 kbps and 320 kbps and VBR

#### **WMA (.wma/.WMA):**

- Supported sampling rates: 44.1 kHz, 48 kHz
- Supported bitrates: Between 5 kbps and 320 kbps and VBR
- WMA Pro/Voice/WMA Lossless formats are not supported

#### **WAV (.wav/.WAV):**

WAV files include uncompressed PCM digital audio.

- Supported sampling rates: 44.1 kHz, 48 kHz, 88.2 kHz, 96 kHz, 176.4 kHz, 192 kHz
- Quantization bit: 8 bit, 16 bit, 24 bit

#### **AIFF (.aiff/.aif/.AIFF/.AIF):**

AIFF files include uncompressed PCM digital audio.

- Supported sampling rates: 44.1 kHz, 48 kHz, 88.2 kHz, 96 kHz, 176.4 kHz, 192 kHz
- Quantization bit: 8 bit, 16 bit, 24 bit

#### **AAC (.aac/.m4a/.mp4/.3gp/.3g2/.AAC/.M4A/.MP4/.3GP/.3G2):**

- Supported formats: MPEG-2/MPEG-4 Audio
- Supported sampling rates: 44.1 kHz, 48 kHz, 88.2 kHz, 96 kHz
- Supported bitrates: Between 8 kbps and 320 kbps and VBR

#### **FLAC (.flac/.FLAC):**

- Supported sampling rates: 44.1 kHz, 48 kHz, 88.2 kHz, 96 kHz, 176.4 kHz, 192 kHz
- Quantization bit: 8 bit, 16 bit, 24 bit

#### **LPCM (Linear PCM):**

- Supported sampling rates: 44.1 kHz and 48 kHz
- Quantization bit: 16 bit

#### **Apple Lossless (.m4a/.mp4/.M4A/.MP4):**

- Supported sampling rates: 44.1 kHz, 48 kHz, 88.2 kHz, 96 kHz
- Quantization bit: 16 bit, 24 bit

#### **DSD (.dsf/.dff/.DSF/.DFF):**

- Supported formats: DSF/DSDIFF
- Supported sampling rates: 2.8 MHz, 5.6 MHz
- Variable bit-rate (VBR) files are supported. However, playback times may not be displayed correctly.
- Remote playback does not support the gapless playback.

## **Device Requirements**

### **USB Storage**

- Note that operation is not guaranteed with all USB storage devices.

- This unit can use USB storage devices that comply with the USB mass storage device class standard. The unit is also compatible with USB storage devices using the FAT16 or FAT32 file system formats.
- If the USB storage device has been partitioned, each section will be treated as an independent device.
- Up to 20,000 tracks per folder can be displayed, and folders may be nested up to 16 levels deep.
- USB hubs and USB storage devices with hub functions are not supported. Do not connect these devices to the unit.
- USB storage devices with security function are not supported on this unit.
- If you connect a USB hard disk drive to the USB port of the unit, we recommend that you use its AC adapter to power it.
- Media inserted to the USB card reader may not be available in this function. Furthermore, depending on the USB storage device, proper reading of the contents may not be possible.
- We accept no responsibility whatsoever for the loss or damage to data stored on a USB storage device when that device is used with this unit. We recommend that you back up your important music files beforehand.



## License and Trademark



The terms HDMI and HDMI High-Definition Multimedia Interface, and the HDMI Logo are trademarks or registered trademarks of HDMI Licensing LLC in the United States and other countries.



The Wi-Fi CERTIFIED Logo is a certification mark of Wi-Fi Alliance®.



AirPlay, iPad, iPhone, iPod, iPod classic, iPod nano and iPod touch are trademarks of Apple Inc., registered in the U.S. and other countries.

iPad Air and iPad mini are trademarks of Apple Inc.

"Made for iPod", "Made for iPhone" and "Made for iPad" mean that an electronic accessory has been designed to connect specifically to iPod, iPhone, or iPad, respectively, and has been certified by the developer to meet Apple performance standards. Apple is not responsible for the operation of this device or its compliance with safety and regulatory standards.

Please note that the use of this accessory with iPod, iPhone or iPad may affect wireless performance.

AirPlay works with iPhone, iPad, and iPod touch with iOS 4.3.3 or later, Mac with OS X Mountain Lion or later, and PC with iTunes 10.2.2 or later.



PANDORA, the PANDORA logo, and the Pandora trade dress are trademarks or registered trademarks of Pandora Media, Inc. Used with permission.



The BLUETOOTH® word mark and logos are registered trademarks owned by Bluetooth SIG, Inc.

The Spotify software is subject to third party licenses found here:  
<https://developer.spotify.com/esdk-third-party-licenses/>

This product is protected by certain intellectual property rights of Microsoft. Use or distribution of such technology outside of this product is prohibited without a license from Microsoft.

Windows 7, Windows Media, and the Windows logo are trademarks or registered trademarks of Microsoft Corporation in the United States and/or other countries.

"x.v.Color" and "x.v.Color" logo are trademarks of Sony Corporation.

DSD and the Direct Stream Digital logo are trademarks of Sony Corporation.

All other trademarks are the property of their respective owners. / Toutes les autres marques commerciales sont la propriété de leurs détenteurs respectifs. / El resto de marcas comerciales son propiedad de sus respectivos propietarios. / Tutti gli altri marchi di fabbrica sono di proprietà dei rispettivi proprietari. / Alle anderen Warenzeichen sind das Eigentum ihrer jeweiligen Eigentümer. / Alle andere handelsmerken zijn eigendom van de desbetreffende rechthebbenden. / Alla andra varumärken tillhör deras respektive ägare. / Kaikki muut tuotemerkit ovat omistajiensa omaisuutta. / 所有其他商標為各自所有者所有。

# Integra®

1-10-5 Yokoami, Sumida-ku, Tokyo 130-0015 JAPAN  
<http://www.integraworldwide.com>

## <U.S.A.>

18 Park Way, Upper Saddle River, N.J. 07458, U.S.A.  
Tel: 800-225-1946, 201-818-9200 Fax: 201-785-2650  
<http://www.integrahometheater.com>

## <Germany>

Gutenbergstrasse 3, 82178 Puchheim, Germany  
Tel: +49-8142-4401-0 Fax: +49-8142-4208-213  
<http://www.integra.eu>

## <PRC>

302, Building 1, 20 North Chaling Rd., Xuhui District, Shanghai, China 200032,  
Tel: +86-21-52131366 Fax: +86-21-52130396  
<http://www.integra.com.cn>

