

OUTDOOR SPEAKERS

OD25, OD26, GA10 SUBWOOFER



OUTDOOR SPEAKERS

OD25, OD26, GA10 SUBWOOFER

The Triad Outdoor Speaker System with Garden Array Subwoofer is a family of premium, all-weather outdoor speakers that are the perfect combination of aesthetics, sound, and durability. This family includes the OD25 and OD26 Outdoor Satellite speakers and, for additional low-frequency bass reinforcement, the powerful GA10 Subwoofer. These speakers are the perfect choice for rich, beautiful outdoor entertainment.

The OD25 and OD26 Outdoor Satellite speakers feature an adjustable bracket for easy, discreet mounting to all surfaces. They also feature the same Acoustiperf grill as all of the Triad indoor speakers, but in an anti-corrosion aluminum alloy material for outdoor durability.

The compact—yet powerful—GA10 Subwoofer is designed for both above- and below-ground installations so the bass can be located exactly where you want it—on the patio or deck, or buried near a pool, gazebo, or pergola. Kits are available for either type of installation. The Triad Outdoor Speaker System, combined with the Garden Array Subwoofer, is the perfect choice for scalable outdoor entertainment.

FEATURES

- IP66 all-weather enclosure and design
- Compact size, designer friendly

OD25, OD26

- Proprietary baffle design and internal components for great sound
- Weather-resistant, acoustic suspension enclosure available in either black or white finish
- Aluminum, non-corrosive grill
- Adjustable vertical or horizontal mounting system
- Premium, gold-plated binding posts

GA10 SUBWOOFER

- 10" long-throw, weather-resistant, composite woofer
- Can be mounted above or below ground with optional Foot or Underground kits (sold separately)
- Maximum power handling 300 watts

OUTDOOR SPEAKERS OD25, OD26, GA10 SUBWOOFER

SPECIFICATIONS

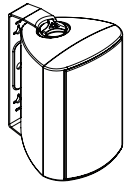

OD25

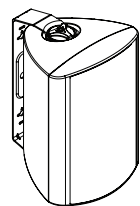

OD26

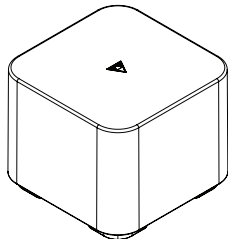

GA10 SUB

MATERIALS

Tweeter size	(1) 1" (25 mm)
Tweeter type	Titanium
Woofer size	(1) 5 1/4" (14 cm)
Woofer type	Carbon fiber

OD26

(1) 1" (25 mm)
Titanium
(1) 6 1/4" (17 cm)
Carbon fiber

GA10 SUB

-
-
(1) 10" (25.4 cm)
Composite

PERFORMANCE

Recommended amplifier power	25 - 150W
Impedance	6 ohm
Sensitivity (dB @ 2.83V, 1 m)	84 dB
Frequency response (+/- 3 dB)	75 Hz - 20 kHz
Weather-resistance	IP66

OD26

25 - 150W
6 ohm
86 dB
65 Hz - 20 kHz
IP66

GA10 SUB

300W
4 ohm
Max output 102 dB
27 Hz - 300 Hz
IP57

DIMENSIONS

H x W x D	10 9/16 x 7 1/2 x 8 1/2" (27 x 19 x 21.6 cm)
-----------	---

OD26

12 1/2 x 8 13/16 x 9 15/16" (31.7 x 22.4 x 23.7 cm)
--

GA10 SUB

10 1/4 x 13 3/4 x 13 3/4" (26 x 35 x 35 cm)
--

PRODUCT WEIGHT

Each	7.5 lb (3.4 kg)
------	-----------------

OD26

9 lb (4.1 kg)

GA10 SUB

23.6 lb (10.72 kg)

SHIPPING WEIGHT

Per pack	17 lb (7.7 kg)
----------	----------------

OD26 (pair)

21 lb (9.5 kg)

GA10 SUB (each)

29 lb (13.15 kg)

PRODUCT NUMBERS

Black finish	30251-1
White finish	30250-1

OD26 (pair)

30261-1
30260-1

GA10 SUB (each)

30341-1

GA10 SUB UNDERGROUND KIT

Height (from woofer base to top of cap)	28 1/2" (72.4 cm)
Cap (Ø x H)	Ø 10 1/4 x 3 1/2" (Ø 26 x 8.9 cm)
Pipe	Ø 4 5/16" (Ø 10.9 cm)

Product number - 30350-1

28 1/2" (72.4 cm)
Ø 10 1/4 x 3 1/2" (Ø 26 x 8.9 cm)
Ø 4 5/16" (Ø 10.9 cm)

GA10 SUB FOOT KIT

Feet (4 count) (HxWxD)	1 1/8 x 3 3/4 x 3 3/4" (2.8 x 9.5 x 9.5 cm)
------------------------	---

Product number - 30351-1

1 1/8 x 3 3/4 x 3 3/4" (2.8 x 9.5 x 9.5 cm)

Product page



triadspkrs.co/
outdr2526

DIMENSIONS

OD25

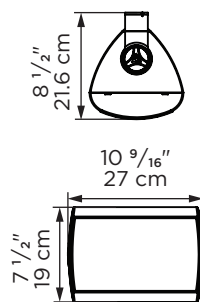

OD26

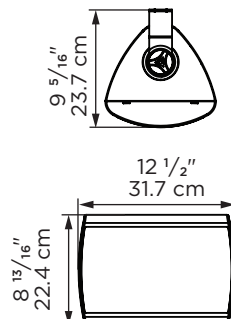

GA10 SUB

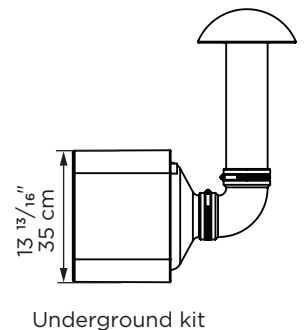
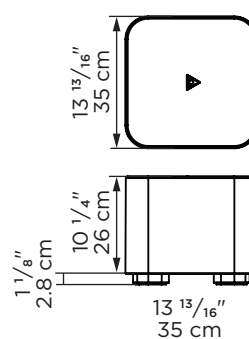

Underground kit